

LEGEND = KEY PRODUCT CHARACTERISTICS

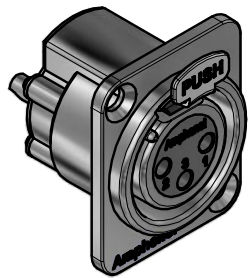

REVISION HISTORY				
REV	DESCRIPTION	DATE	BY	ECN
1	FIRST ISSUE	01/02/19	MH	----



3D VIEW

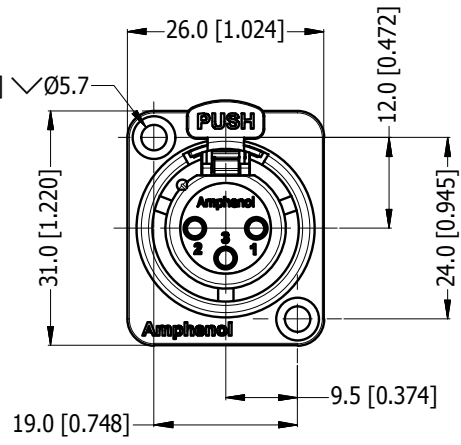

THROUGH HOLE

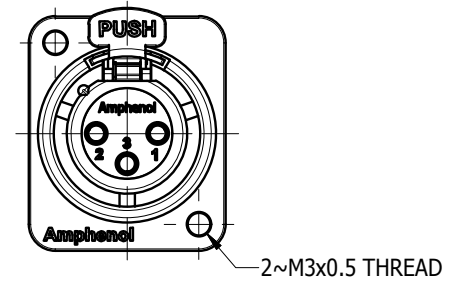
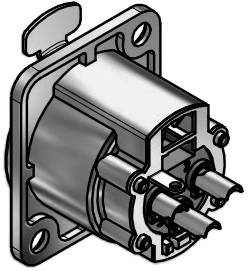
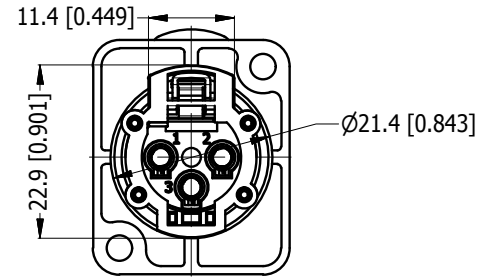
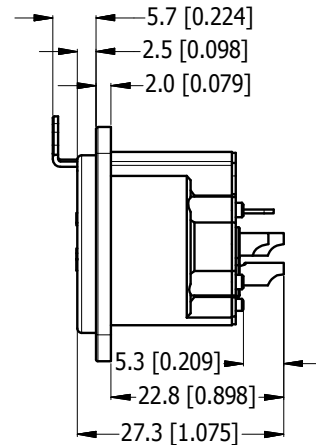

M3 THREAD OPTION

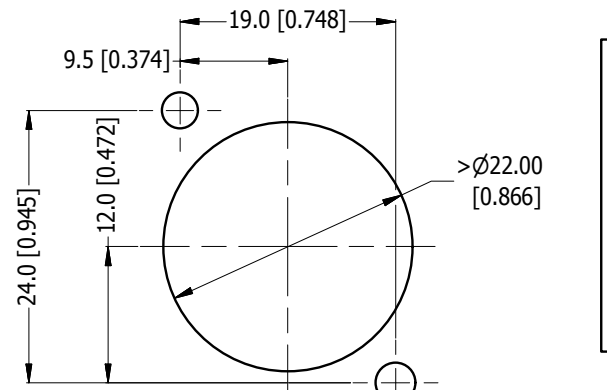

PANEL CUT OUT (SCALE 2:1)

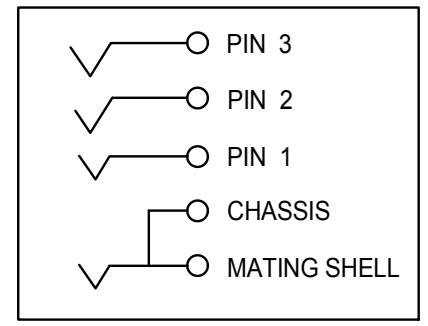

SCHEMATIC CHART

PART NUMBER	SHELL FINISH	PIN CONTACT FINIS
AX3FD	NICKEL PLATED	TIN PLATED
AX3FDB	MATT BLACK COATING	TIN PLATED
AX3FD-M3	M3 THREAD - NICKEL PLATED	TIN PLATED
AX3FDB-M3	M3 THREAD - MATT BLACK COATING	TIN PLATED
AX3FD-AU	NICKEL PLATED	GOLD PLATED
AX3FDB-AU	MATT BLACK COATING	GOLD PLATED
AX3FD-AU-M3	M3 THREAD - NICKEL PLATED	GOLD PLATED
AX3FDB-AU-M3	M3 THREAD - MATT BLACK COATING	GOLD PLATED

UNLESS OTHERWISE SPECIFIED TOLERANCE TO BE	
LINEAR	ANGULAR
X ± 0.5	X' ± 1
X.X ± 0.2	X.X' ± 30'
X.XX ± 0.1	X.XX" ± 15'

BREAK ALL SHARP EDGES AND REMOVE ALL BURRS

DO NOT SCALE

THIS DOCUMENT IS THE PROPERTY OF AMPHENOL AUSTRALIA PTY. LTD.
 NO PART THEREOF MAY BE REPRODUCED AND USED WITHOUT THE PRIOR WRITTEN CONSENT OF THE OWNER

MATERIAL: **SEE COMPONENT**

DRN: M.H DATE: 01/04/14

CKD: M.H DATE: 01/02/19

APP'D: P.M DATE: 01/02/19

FINISH: **SEE COMPONENT**

SCALE: **1:1** SIZE: **A4**

Amphenol Amphenol Australia Pty.Ltd, 22 Industry Boulevard, Carrum Downs, VIC 3201

TITLE: **AX3FD D-TYPE AX PANEL MOUNT CUSTOMER DWG**

PART No. **SEE TABLE**

DRAWING No. **55011002-100-2** SHEET **2/2**

CAD FILE 55011002100111

DIMENSIONS IN MILLIMETRES