

LEGEND = KEY PRODUCT CHARACTERISTICS

REVISION HISTORY				
REV	DESCRIPTION	DATE	BY	ECN
1	FIRST ISSUE	01/02/19	MH	----

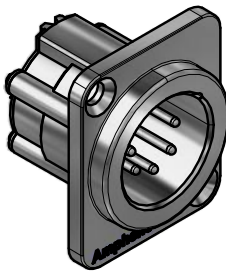

3D VIEW (1:1)

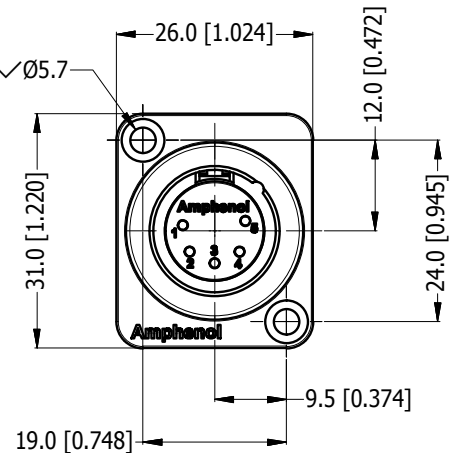
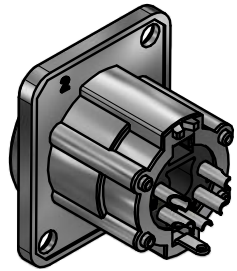

THROUGH HOLE

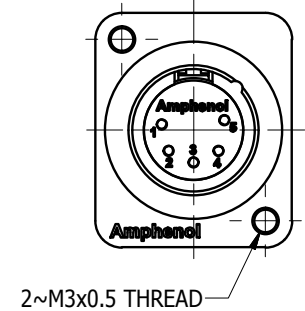

M3 THREAD OPTION

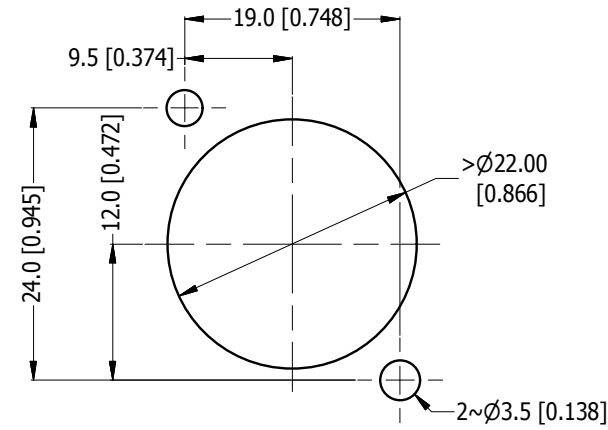
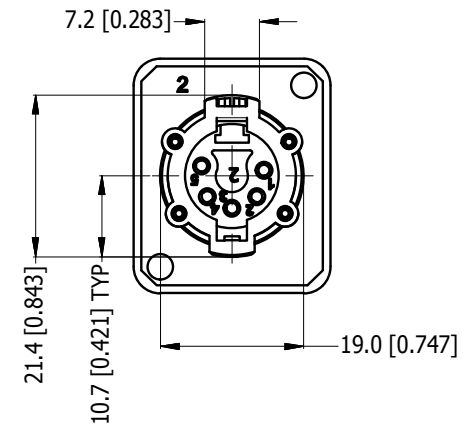
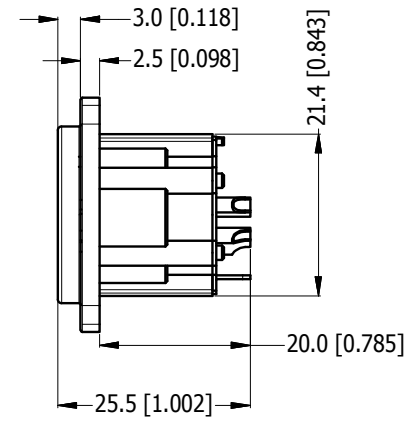

PANEL CUT OUT
(SCALE 2:1)

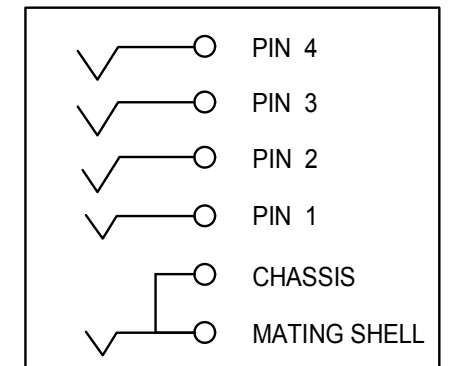

SCHEMATIC CHART

PART NUMBER	SHELL FINISH	PIN CONTACT FINISH
AX5MD	NICKEL PLATED	SILVER PLATED
AX5MDB	MATT BLACK COATING	SILVER PLATED
AX5MD-M3	M3 THREAD - NICKEL PLATED	SILVER PLATED
AX5MDB-M3	M3 THREAD - MATT BLACK COATING	SILVER PLATED
AX5MD-AU	NICKEL PLATED	GOLD PLATED
AX5MDB-AU	MATT BLACK COATING	GOLD PLATED
AX5MD-AU-M3	M3 THREAD - NICKEL PLATED	GOLD PLATED
AX5MDB-AU-M3	M3 THREAD - MATT BLACK COATING	GOLD PLATED

UNLESS OTHERWISE SPECIFIED TOLERANCE TO BE	
LINEAR	ANGULAR
X ± 0.5	X' ± 1
X.X ± 0.1	X.X' ± 30'
X.XX ± 0.1	X.XX" ± 15'

BREAK ALL SHARP EDGES AND REMOVE ALL BURRS

DO NOT SCALE

THIS DOCUMENT IS THE PROPERTY OF AMPHENOL AUSTRALIA PTY. LTD.
NO PART THEREOF MAY BE REPRODUCED AND USED WITHOUT THE PRIOR WRITTEN CONSENT OF THE OWNER

MATERIAL: **SEE COMPONENT**

DRN: M.H DATE: 01/02/19

CKD: M.H DATE: 01/02/19

APP'D: P.M DATE: 01/02/19

FINISH: **SEE COMPONENT**

SCALE: **1:1** SIZE: **A4**

Amphenol Amphenol Australia Pty.Ltd, 22 Industry Boulevard, Carrum Downs, VIC 3201

TITLE: **AX5MD D-TYPE AX PANEL MOUNT CUSTOMER DWG**

PART No. **SEE TABLE**

DRAWING No. **55011001-100-2** SHEET **2/2**

CAD FILE 55011001100111

DIMENSIONS IN MILLIMETRES



THIRD ANGLE PROJECTION