

LEGEND = KEY PRODUCT CHARACTERISTICS

REVISION HISTORY

REV	DESCRIPTION	DATE	BY	ECN
1	FIRST ISSUE	01/02/19	MH	----

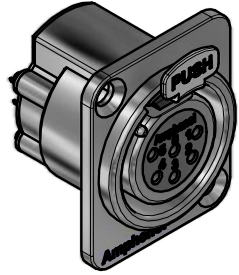

3D VIEW

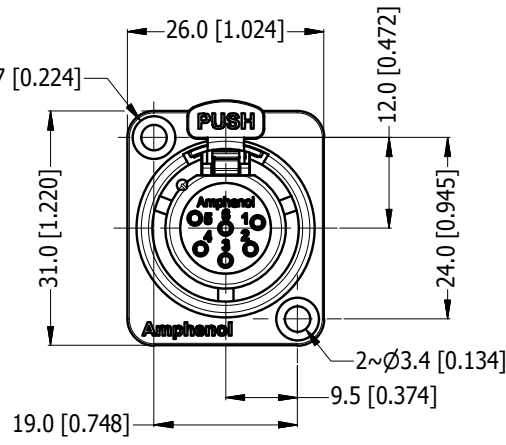
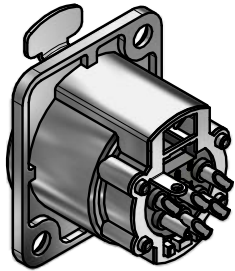

THROUGH HOLE

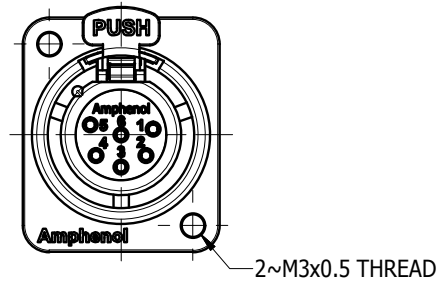

M3 THREAD OPTION

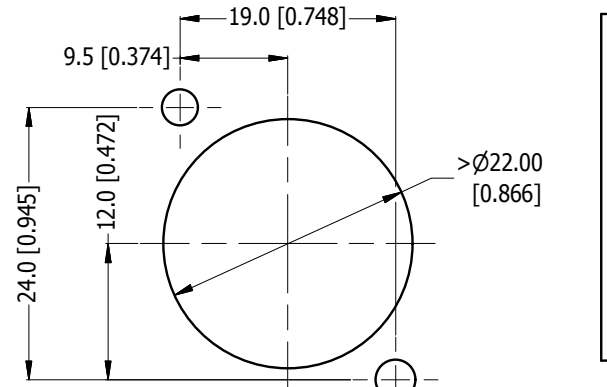
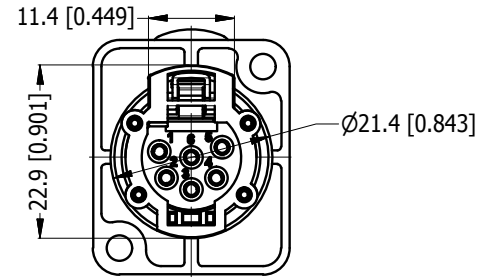
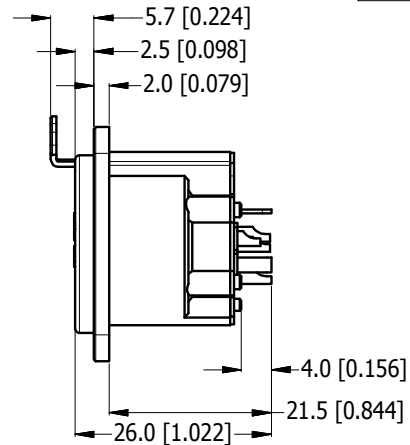

PANEL CUT OUT
(SCALE 2:1)

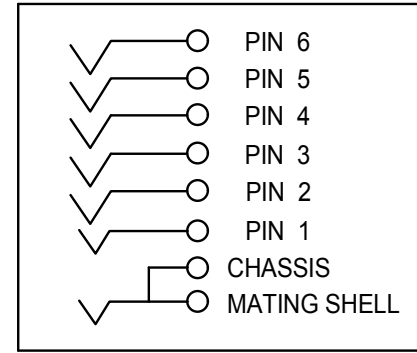

SCHEMATIC CHART

PART NUMBER	SHELL FINISH	PIN CONTACT FINIS
AX6AFD	NICKEL PLATED	TIN PLATED
AX6AFDB	MATT BLACK COATING	TIN PLATED
AX6AFD-M3	M3 THREAD - NICKEL PLATED	TIN PLATED
AX6AFDB-M3	M3 THREAD - MATT BLACK COATING	TIN PLATED
AX6AFD-AU	NICKEL PLATED	GOLD PLATED
AX6AFDB-AU	MATT BLACK COATING	GOLD PLATED
AX6AFD-AU-M3	M3 THREAD - NICKEL PLATED	GOLD PLATED
AX6AFDB-AU-M3	M3 THREAD - MATT BLACK COATING	GOLD PLATED

UNLESS OTHERWISE SPECIFIED TOLERANCE TO BE	
LINEAR	ANGULAR
X ± 0.5	X' ± 1
X.X ± 0.2	X.X' ± 30'
X.XX ± 0.1	X.XX" ± 15'

BREAK ALL SHARP EDGES AND REMOVE ALL BURRS
DO NOT SCALE

THIS DOCUMENT IS THE PROPERTY OF AMPHENOL AUSTRALIA PTY. LTD.
NO PART THEREOF MAY BE REPRODUCED AND USED WITHOUT THE PRIOR WRITTEN CONSENT OF THE OWNER

MATERIAL: SEE COMPONENT	DRN: M.H	DATE: 01/04/14
FINISH: SEE COMPONENT	CKD: M.H	DATE: 01/02/19
	APP'D: P.M	DATE: 01/02/19
	SCALE: 1:1	SIZE: A4

Amphenol Amphenol Australia Pty.Ltd, 22 Industry Boulevard, Carrum Downs, VIC 3201

TITLE: **AX6AFD D-TYPE AX PANEL MOUNT CUSTOMER DWG**

PART No. **SEE TABLE**

DRAWING No. **55011345-100-2** SHEET **2/2**

CAD FILE 55011345100111

DIMENSIONS IN MILLIMETRES