

LEGEND = KEY PRODUCT CHARACTERISTICS

REVISION HISTORY				
REV	DESCRIPTION	DATE	BY	ECN
1	FIRST ISSUE	01/02/19	MH	----
2	CORRECT CONTACT ARRANGEMENT	23/03/21	MH	9642

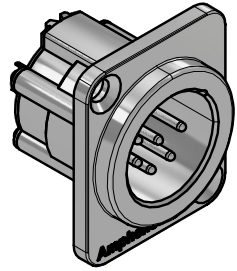

3D VIEW (1:1)

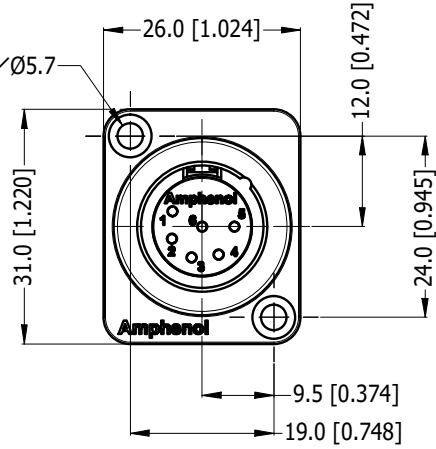

THROUGH HOLE

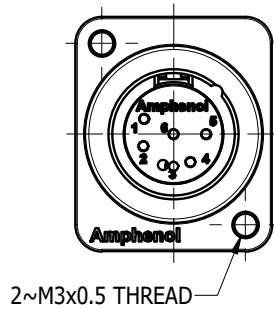
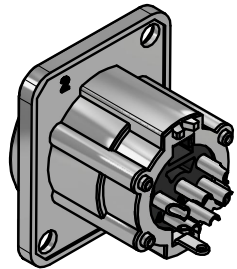
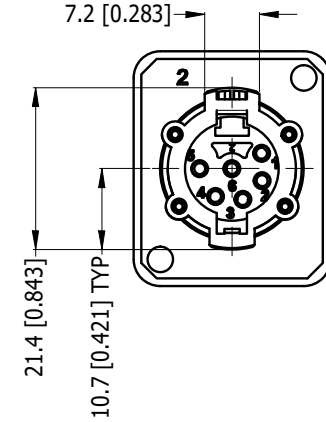
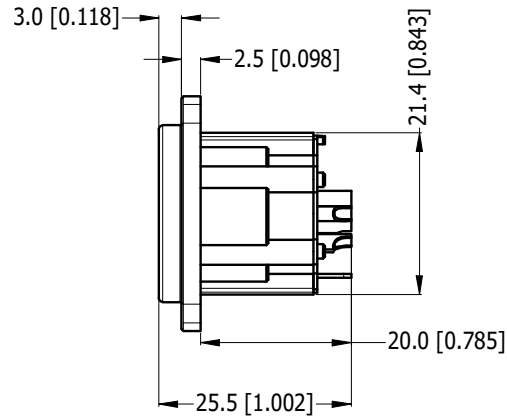

M3 THREAD OPTION

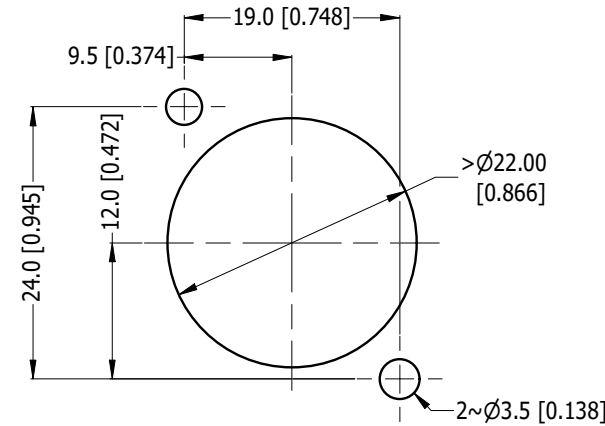

PANEL CUT OUT
(SCALE 2:1)

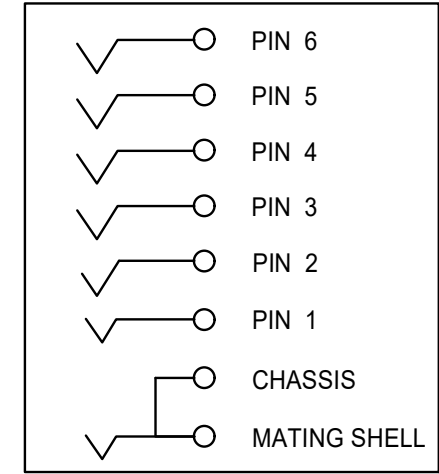

SCHEMATIC CHART

PART NUMBER	SHELL FINISH	PIN CONTACT FINISH
AX6AMD	NICKEL PLATED	SILVER PLATED
AX6AMDB	MATT BLACK COATING	SILVER PLATED
AX6AMD-M3	M3 THREAD - NICKEL PLATED	SILVER PLATED
AX6AMDB-M3	M3 THREAD - MATT BLACK COATING	SILVER PLATED
AX6AMD-AU	NICKEL PLATED	GOLD PLATED
AX6AMDB-AU	MATT BLACK COATING	GOLD PLATED
AX6AMD-AU-M3	M3 THREAD - NICKEL PLATED	GOLD PLATED
AX6AMDB-AU-M3	M3 THREAD - MATT BLACK COATING	GOLD PLATED

UNLESS OTHERWISE SPECIFIED TOLERANCE TO BE	
LINEAR	ANGULAR
X ± 0.5	X' ± 1
X.X ± 0.1	X.X' ± 30'
X.XX ± 0.1	X.XX" ± 15'
BREAK ALL SHARP EDGES AND REMOVE ALL BURRS	
DO NOT SCALE	
DIMENSIONS IN MILLIMETRES	

THIS DOCUMENT IS THE PROPERTY OF AMPHENOL AUSTRALIA PTY. LTD. NO PART THEREOF MAY BE REPRODUCED AND USED WITHOUT THE PRIOR WRITTEN CONSENT OF THE OWNER			
MATERIAL: SEE COMPONENT	DRN: M.H	DATE: 01/02/19	TITLE: AX6AMD D-TYPE AX PANEL MOUNT CUSTOMER DWG
FINISH: SEE COMPONENT	CKD: M.H	DATE: 23/03/21	
	APP'D: P.M	DATE: 23/03/21	
SCALE: 1:1	SIZE: A4	CAD FILE: 55011344100112	

Amphenol Amphenol Australia Pty.Ltd, 22 Industry Boulevard, Carrum Downs, VIC 3201	
PART No. SEE TABLE	
DRAWING No. 55011344-100-2	SHEET 2/2