

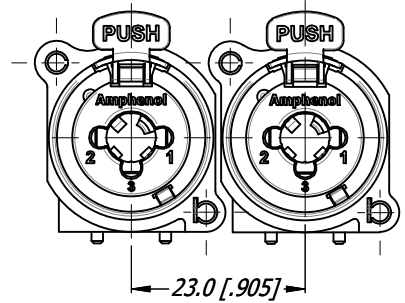

REVISION HISTORY				
REV	DESCRIPTION	BY	DATE	ECN
2	POS OF 2.5 HOLE IN PCB CHANGED	T.N	02/09/15	9320
3	CHANGE TN CONTACTS TO Au PLATING	MH	05/12/23	9740

A
B
C
D
E
F

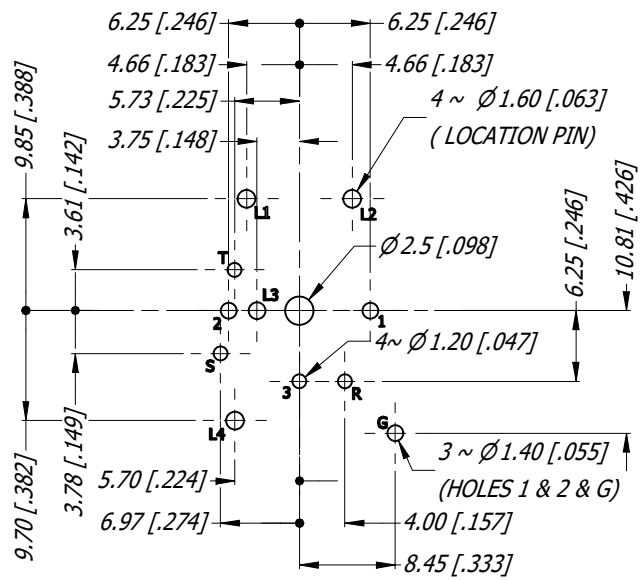
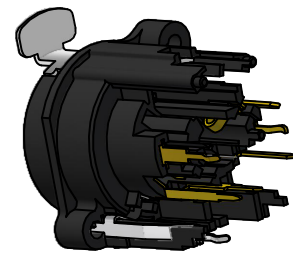
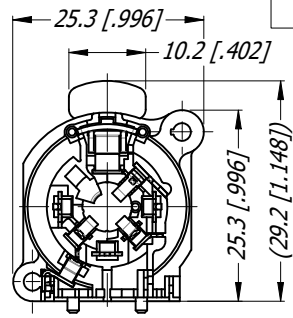
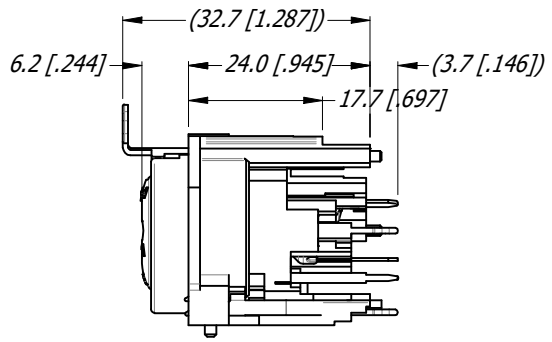
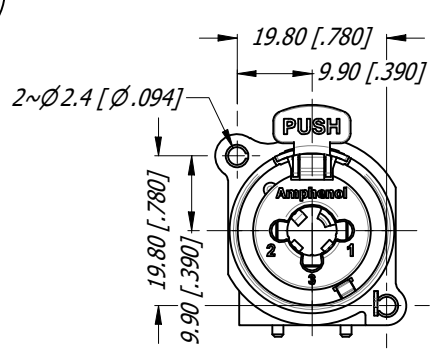

MIN MOUNTING PITCH

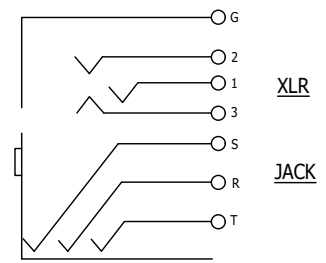
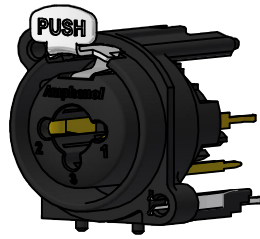

CONTACT SCHEMATIC DIAGRAM

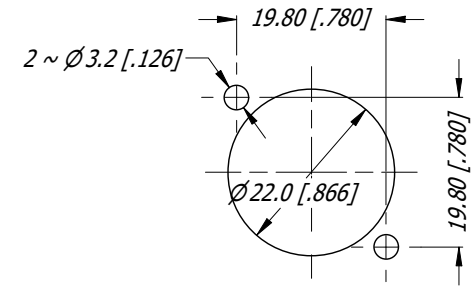

PANEL CUT OUT

PCB LAYOUT SCALE 3:2

UNLESS OTHERWISE SPECIFIED TOLERANCE TO BE	
LINEAR	ANGULAR
X ± 0.5	X° ± 1
X.X ± 0.2	X.X° ± 30'
X.XX ± 0.1	X.XX° ± 15'

BREAK ALL SHARP EDGES AND REMOVE ALL BURRS

DO NOT SCALE

DIMENSIONS IN MILLIMETRES

THIS DOCUMENT IS THE PROPERTY OF AMPHENOL AUSTRALIA PTY. LTD.
NO PART THEREOF MAY BE REPRODUCED AND USED WITHOUT THE PRIOR WRITTEN CONSENT OF THE OWNER

MATERIAL: **SEE COMPONENTS**

FINISH: **SEE COMPONENTS**

DRN: T.N DATE: 09/07/14

CKD: MH DATE: 05/12/23

APP'D: PM DATE: 05/12/23

SCALE: **1:1** SIZE: **A4**

Amphenol Amphenol Australia Pty.Ltd,
22 Industry Blvd, Carrum Downs, VIC 3173

TITLE: **C TYPE LOW PROFILE 6 CONTACTS VERTICAL CUSTOMER DWG**

PART No: **ACJC6AV2**

DRAWING No. **55011016-000** SHEET **6 /16**

A
B
C
D
E
F