

Amphenol Australia

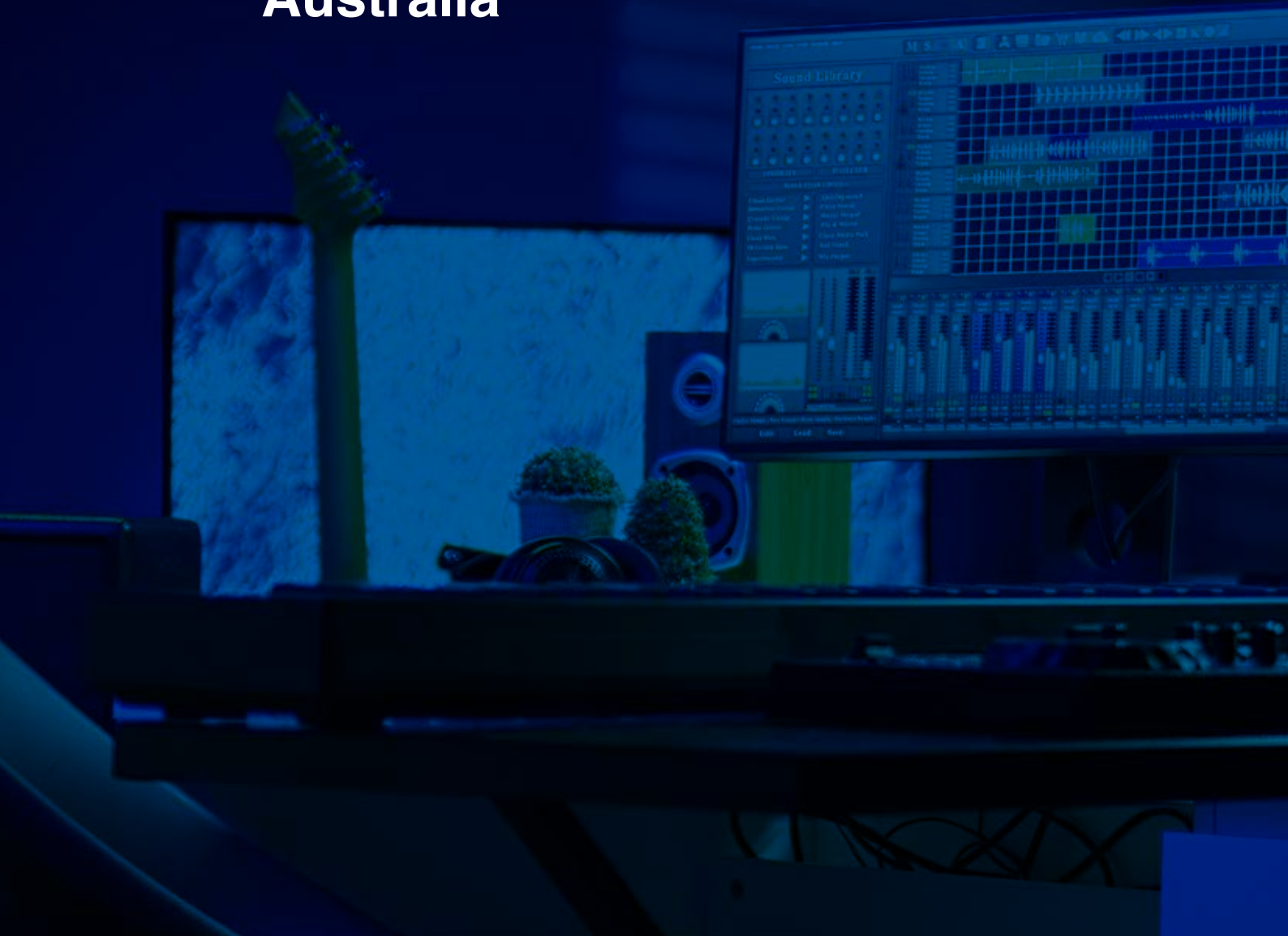

ENTERTAINMENT @ AMPHENOL
TRUSTED GLOBALLY

ENTERTAINMENT INTERCONNECT CATALOGUE



Amphenol Australia Pty. Ltd.

Amphenol Australia's head office is based in Melbourne, Victoria and is the Sales, Marketing and Engineering centre of excellence for an extensive range of professional connector and cabling products.

Amphenol's global presence allows us to take full advantage of our numerous corporate resources and product portfolio to provide you with a vast offering and choice. Our extensive range is designed to meet the specific needs of the entertainment markets to make the selection of your interconnect partner an easy choice.

The company has been producing products for the pro-audio industry for over fifty years. Since the development of our XLR AC Series connectors, we have continued to provide our customers with exacting quality in an increasingly competitive environment.

Continuous improvement through ISO9001, a focus on environmental awareness and development of next generation industry leading products is our philosophy. As the entertainment industry moves into the future the emerging technologies from other industries has become more prevalent and more challenging. Amphenol Australia's global presence combined with its close technical relationships with other Amphenol sister divisions, each a specialist and leader in their own interconnect field, places it well to support innovation and meet this challenge head on.

The ability of Amphenol to provide a full range of design services required to support the customers applications design and modelling, applications engineering, fabrication, value-added assembly and testing, coupled with the largest interconnect offering on the market means that we can support all of your system level needs.

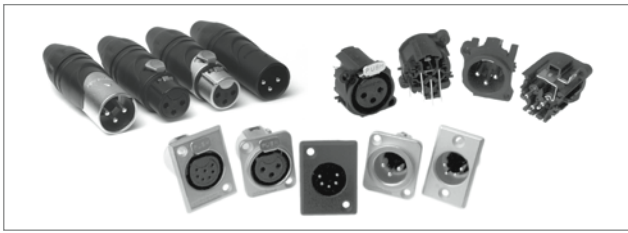

XLR Connectors

AX Series XLR Cable Connectors	4
AC Series XLR Cable Connectors	11
AC/AX Series XLR Metal Chassis Mount Connectors	18
XLR IP65 Connectors	30
XLRnet IP65 Range	36
AC Series XLR PCB Chassis Mount Connectors.....	43
AC Series Dual 1/4" (6.35mm) / XLR Chassis Mount	57
G-Type Miniature XLR Connectors	66



Plugs & Jacks

T Series Plugs	114
T Series (Jumbo) Plugs	116
T-Series SwitchPlug	118
Q Series Plugs	120
Musician Series II Plugs	123
1/4" / 3.5mm Phone Jack Connectors	128
K Series Plugs (3.5mm)	138



Data Connectors

Amphe-Dante Adapters	90
XLRnet Series Cable Connector	94
XLRnet Series Cable Connector	96
XLRnet Series A & B Type Chassis Receptacles	99
XLRnet Series D Type Chassis Receptacles	105
USB/HDMI Series	110



Speaker Connectors

SP Series	71
EP Series	80
AP Series	82



Power Connectors

HP Series	85
HPT Series	87



Plugs & Sockets

RCA Series	142
------------------	-----



Multipin Connectors

MP-41 Series	146
MP-62/65 Series	151

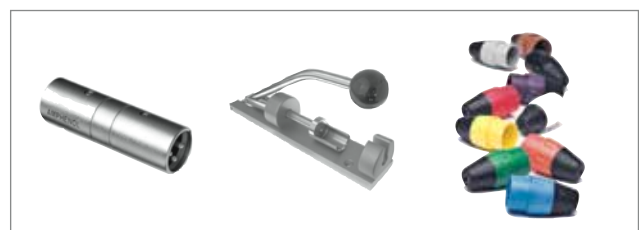

Miscellaneous

Accessories	154
Connector Wiring Information	158
Index	160
Product Safety Information	164

XLR Connectors

AX Series XLR Cable Connectors



AX SERIES XLR CABLE CONNECTORS

The revolutionary AX series of XLR connectors introduce an exciting contemporary look and feel to the professional audio interconnect market. They are designed to complement modern audio architecture and truly "fit" within their environment. An impressive list of features guarantees pure sound performance in the most demanding applications providing unrivalled value.

Features

- Unique Australian designed shell and housing.
- One piece ground / latch spring design incorporating twin wipe contacts for a direct connection path from mating shell to ground providing enhanced connection and EMI performance.
- Ergonomic sleeve design for improved grip.
- Channel I.D capability with coloured sleeves.
- Oversized ergonomic latch for quick and easy mating.
- Leading first mate last break pin 1 on socket connectors.
- Chuck style cable clamp to suit 3mm - 8mm (0.118" - 0.314") cable O.D. with integrated split to allow inclusion after soldering.
- Concealed latching point for improved aesthetics, sealing and strength.
- Overmolded boot with flex bend relief for improved aesthetics, cable protection and boot retention.
- Concentric socket contact design provides optimal contact resistance
- Precision machined pin contacts as standard.
- Compact solder buckets to reduce termination time and material wastage during the soldering process.
- Zinc diecast shell housing for robustness and wear with Satin nickel or Black finish.
- Available in 3,4 and 5 contact arrangements.

Options

- Coloured I.D sleeves.
- Satin nickel or Black shell finish.
- Single or Bulk packaging.
- Gold plated contacts.

Ordering Codes

We have listed the more common ordering codes in each section. For further options please refer to the part number breakdown charts. Please contact us if you need any further assistance.

Simple steps to guide you in using this catalogue

- 1) Identify the product group listed in Contents on page 1 and go directly to that page number.
- 2) Each product group cover page then details information and options available.
- 3) Refer to the product detail pages and identify the product you require pictorially.
- 4) Read the product description column for the products standard features.
- 5) Use variations column to determine your choice.
- 6) Identify part number.
- 7) In the event the particular option you require is not listed please refer to the part number breakdown page at the end of each section.
- 8) Please contact us directly if you have any further problems.

XLR Connectors

AX Series XLR Cable Connectors



Features:

- Unique Australian designed shell and housing.
- Ergonomic stylish sleeve design for improved grip.
- Oversized latch lever preserves your thumb.
- Leading first mate last break pin 1 on socket connectors.
- Chuck style cable clamp to suit 3mm - 8mm (0.118" - 0.314") cable O.D. with integrated split to allow inclusion after soldering.
- Overmolded cable support boot.
- New socket contact design for improved contact resistance.
- Precision machined pin contacts as standard.
- Compact solder buckets to reduce soldering time and wastage.
- Zinc diecast shell housing with Satin nickel or Matt black finish.
- Available in 3,4 and 5 contact arrangements.







Options:

- Coloured I.D sleeves.
- Satin nickel or Matt black shell finish.
- Single or Bulk packaging.

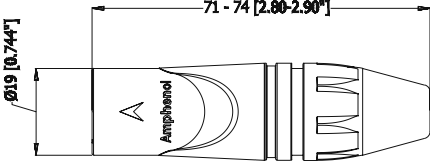
Part Number Breakdown: Page 7

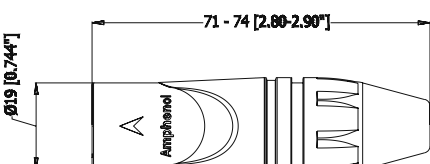
Specifications: Page 10

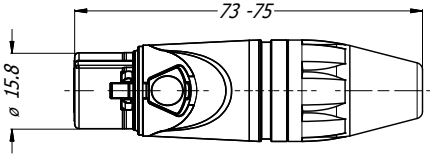

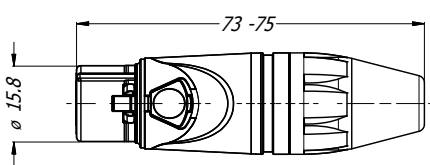







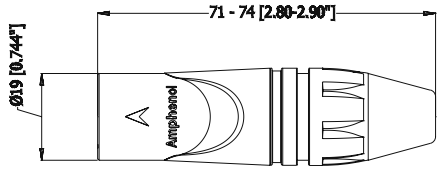

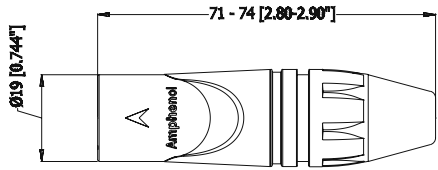

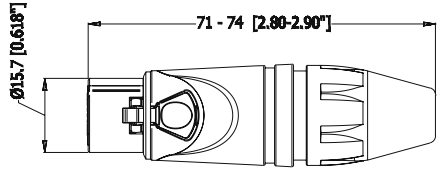
Assembly Instructions: Page 8 & 9

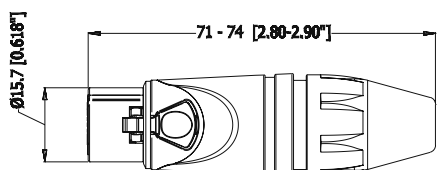
PRODUCT - FIGURE	DRAWING	Dimensions in mm (inches)	DESCRIPTION	VARIATIONS	PART NUMBER
		71 - 74 [2.80-2.90"] Ø19 [0.744"]	XLR 3 pole male Machined contacts Nickel Finish	Standard Bulk Pack	AX3M AX3M BULK
		71 - 74 [2.80-2.90"] Ø19 [0.744"]	XLR 3 pole male Machined contacts Black Finish	Standard Gold Plated Contacts Bulk Pack	AX3MB AX3MB-AU AX3MB BULK
		73 - 75 Ø 15.8	XLR 3 pole female Stamped contacts Nickel Finish	Standard Bulk Pack	AXX3F AXX3F BULK
		73 - 75 Ø 15.8	XLR 3 pole female Stamped contacts Nickel Finish	Standard Gold Plated Contacts Bulk Pack	AXX3FB AXX3FB-AU AXX3FB BULK

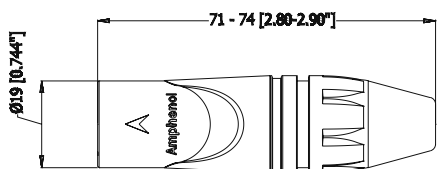
*PI538 is available for download at www.amphenolaudio.com

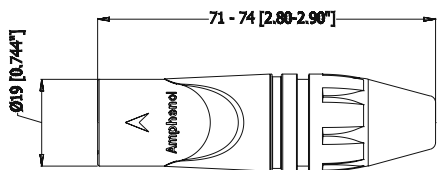
XLR Connectors

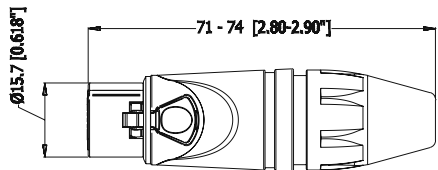
AX Series XLR Cable Connectors

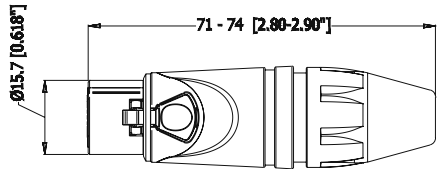
PRODUCT - FIGURE	DRAWING	DESCRIPTION	VARIATIONS	PART NUMBER
		XLR 4 pole male Machined contacts Nickel Finish	Standard	AX4M
			Bulk Pack	AX4M BULK
		XLR 4 pole male Machined contacts Black Finish	Standard	AX4MB
			Gold Plated Contacts	AX4MB-AU
			Bulk Pack	AX4MB BULK
		XLR 4 pole female Machined contacts Nickel Finish	Standard	AX4F
			Bulk Pack	AX4F BULK
		XLR 4 pole female Machined contacts Black Finish	Standard	AX4FB
			Gold Plated Contacts	AX4FB-AU
			Bulk Pack	AX4FB BULK
		XLR 5 pole male Machined contacts Nickel Finish	Standard	AX5M
			Bulk Pack	AX5M BULK
		XLR 5 pole male Machined contacts Black Finish	Standard	AX5MB
			Gold Plated Contacts	AX5MB-AU
			Bulk Pack	AX5MB BULK
		XLR 5 pole female Machined contacts Nickel Finish	Standard	AX5F
			Bulk Pack	AX5F BULK
		XLR 5 pole female Machined contacts Black Finish	Standard	AX5FB
			Gold Plated Contacts	AX5FB-AU
			Bulk Pack	AX5FB BULK

PART NUMBER BREAKDOWN

METAL SHELL TYPE - SOLDER

E. G . **AX3MB2M-AU BULK**
AX (Series Prefix), **3** contacts, **Male**, **Black** Finish,
2 (Red Sleeve) **M** (Sleeve Marking) - **AU** (Gold Plated Contacts), **Bulk** Packaged.

SERIES PREFIX	AX = Series Prefix
CONTACT LAYOUTS	3 = 3 Contacts 4 = 4 Contacts 5 = 5 Contacts
GENDER	F = Female Socket Contacts M = Male Pin Contacts
SHELL FINISH	Blank = Nickel Plated Finish B = Black Finish
SLEEVE COLOUR OPTION	Blank = Black 1 = Brown 2 = Red 3 = Orange 4 = Yellow 5 = Green 6 = Blue 7 = Violet 8 = Grey 9 = White
SLEEVE MARKING	Blank = Standard Sleeve OM = Marking Sleeve (Black) M = Marking Sleeve (Colour)
CONTACT PLATING	Blank = Standard Plating (Silver or Tin) <small>(Refer to Standard Data)</small> AU = Gold Plated
PACKAGING	Blank = Individual Bags BULK = Bulk Packed

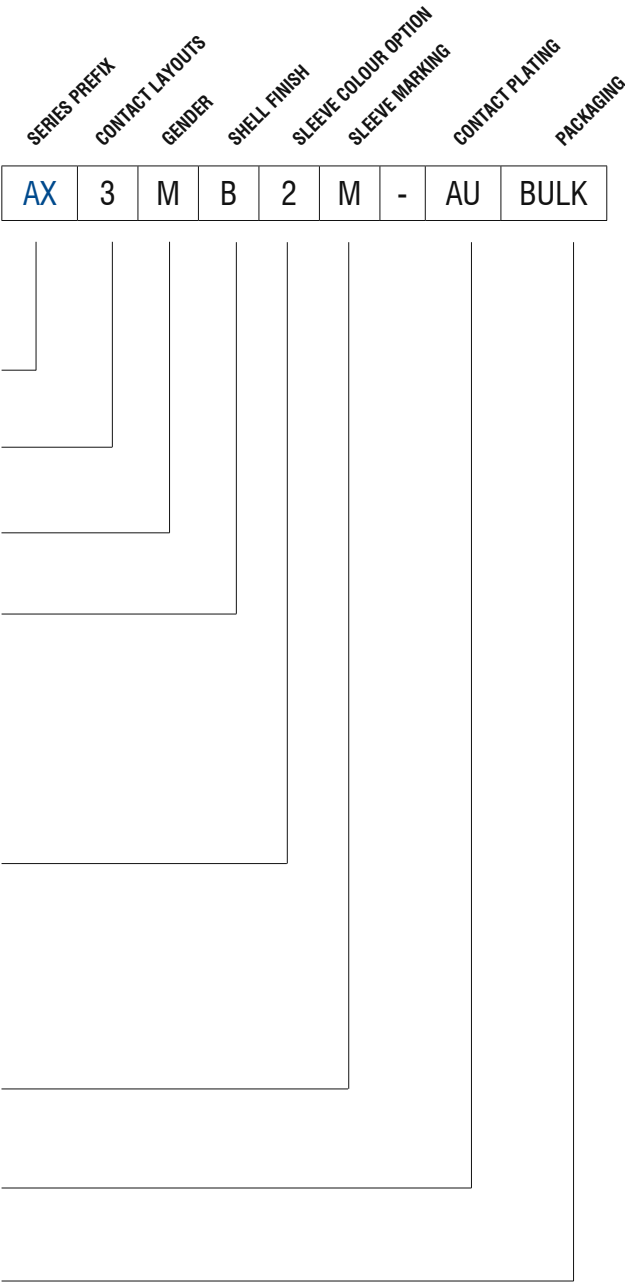

XLR Connectors

AX Series XLR Cable Connectors

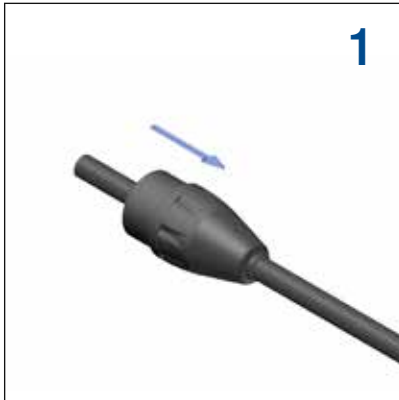

Slide the nut (Backshell) onto the cable

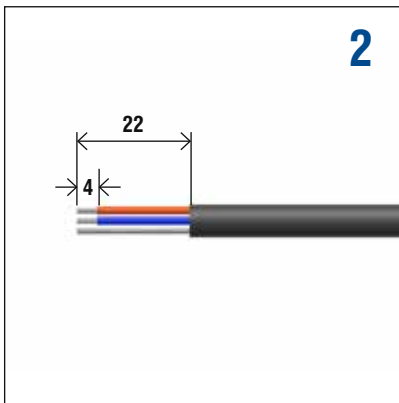

Strip the cable



Push back the insert only enough to expose the solder buckets. It is not necessary to remove the insert. Solder the wires to the contacts.



Install the cable clamp, flush to the insert making sure to align the top slot with the spring. Then push the insert & cable clamp together into the shell.



Thread the nut (Backshell) onto the shell (Torque 0.8Nm - 1.2Nm) to activate the cable clamp and close the connector assembly.

PI539 ASSEMBLY INSTRUCTIONS

AX SERIES FEMALE XLR CABLE CONNECTOR

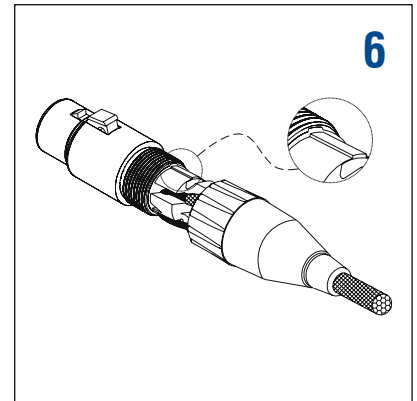

Close the cable clamp slightly and push the boot over the clamp ensuring the wires fit inside the boot.

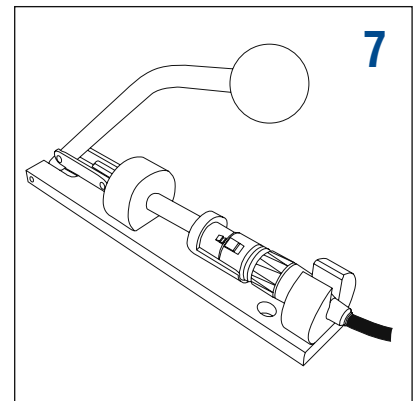

Final assembly can be achieved either by manually screwing the boot on, or by using an Amphenol Australia T2860 termination tool.

PI538 ASSEMBLY INSTRUCTIONS

AX SERIES MALE XLR
CABLE CONNECTOR

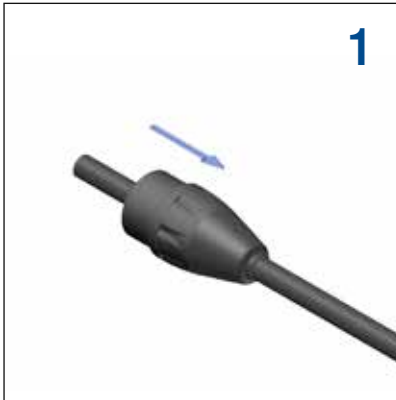

Slide the nut (Backshell) onto the cable

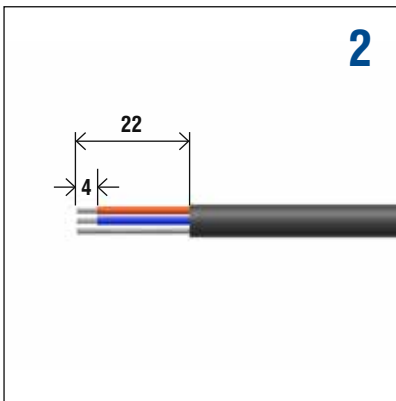

Strip the cable

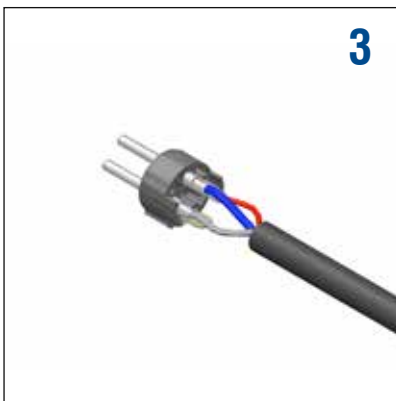

Solder the wires to the contacts.



Install the cable clamp flush to the insert making sure to align the slot with the ground contact.



Align the key of the insert with the keyway on the shell then push the pin insert & cable clamp together in the shell.





Thread the nut (Backshell) onto the shell (Torque 0.8Nm - 1.2Nm) to activate the cable clamp and close the connector assembly.

XLR Connectors

AX Series XLR Cable Connectors

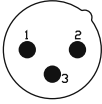
STANDARD DATA AX SERIES CABLE CONNECTORS

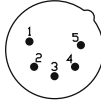
		VALUE		
GENERAL CHARACTERISTICS	Number of contacts	3	4	5
	AX Series Contact Arrangements (Front view of pin inserts)			
	Termination	SOLDER		
	Max. Wire Gauge - Stranded wire: Solder	14AWG	16AWG	18AWG
	Flammability rating of insulator plastics and housings	UL94V-0		
	Environmental	Complies with EU RoHS 2 Directive 2011/65/EU		
ELECTRICAL CHARACTERISTICS	Service Voltage RMS	133V ¹⁾		
	Test Voltage AC RMS	1400V		
	Current carrying capacity: Solder	15A	10A	7.5A
	Typical Contact Resistance	≤3m Ω		
	Insulation Resistance	≥1G Ω		
CLIMATIC CHARACTERISTICS	Protection Class	IP40		
	Operating Temperature	-25°C to +75°C (-13°F to +167°F)		
MECHANICAL CHARACTERISTICS	Insertion and Withdrawal force	≥10N - ≤30N		
	Weight ²⁾	31g (0.068lb)	33g (0.073lb)	33g (0.073lb)
	Typical Cable retention force	22Kg to 44Kg (50lb to 100lb) - Dependent on cable material and diameter.		
	Cable O.D. range	3mm to 8mm (0.118" to 0.314")		
	Mechanical Operations	1000 mating cycles		
MATERIALS	Connector shell - Metal Shell finish	Diecast Zinc Alloy Satin nickel or Black		
	Insulators	UL94V-0 PA66, 30% Glass Filled		
	Boot / Backshell Finish	UL94V-0 Noryl N190 / Santoprene Black, other colours available - see page 80		
	Cable clamp	Noryl N190		
	Sleeve	Noryl N190		
	Male Contact Machined - Solder / Plating	Brass / Silver or Gold (Optional)		
	Female Contact Stamped - Solder / Plating	Phosphor Bronze / Tin or Gold (Optional)		

Rev 3 - 03/2013

¹⁾ Not suitable for domestic applications above 50V

²⁾ Approximate weight only, does not include packaging. Please contact us for exact weight for shipping purposes.

AC SERIES XLR CABLE CONNECTORS



Amphenol Australia have been manufacturing and designing innovative XLR connectors since 1955. The AC series cable connector range complies with IEC268-12 and AES 14-1992 standards. CSA File Number 68598.

Features

- AC series XLR connectors feature the unique Australian design and patented "Jaws" cable retention system
- A leading first mate last break socket contact is standard on all female connectors (Pin 1).
- The "Jaws" cable retention system provides up to 44kg (100lb) of strain.
- The AC series connector can be quickly and easily assembled without screws – by hand or portable termination tool. (Part number T2860)
- Available in 3, 4, 5, 6A and 7 contact arrangements.
- Compatible with all major XLR brands.

Options

- Solder Bucket termination
- Thermoplastic shell
- Zinc Diecast shell - Satin Nickel Finish
- Zinc Diecast shell - Black Polyester Finish
- Gold, Silver or Tin Plated contacts
- Bulk Style Packaging
- Single Bag packs
- Precision machined contacts
- Cost effective stamped contacts on 3 pole
- Standard Jaws cable clamp, Cable O.D 3mm to 6.5mm (0.118" to 0.255")
- Large Jaws cable clamp, Cable O.D 6.5mm to 8mm (0.255" to 0.314")
- Metal Boots / Backshells
- Coloured Boots / Backshells
- Coloured Identification rings
- Termination / Assembly tooling

Jaws Cable Clamp Options



Standard Jaws cable clamp (Black), Cable O.D 3mm to 6.5mm (0.118" to 0.255")



Large Jaws cable clamp (Purple), Cable O.D 6.5mm to 8mm (0.255" to 0.314")

Ordering Codes

We have listed the more common ordering codes in each section. For further options please refer to the part number breakdown charts. Please contact us if you need any further assistance.

Simple steps to guide you in using this catalogue

- 1) Identify the product group listed in Contents on page 1 and go directly to that page number.
- 2) Each product group cover page then details information and options available.
- 3) Refer to the product detail pages and identify the product you require pictorially.
- 4) Read the product description column for the products standard features.
- 5) Use variations column to determine your choice.
- 6) Identify part number.
- 7) In the event the particular option you require is not listed please refer to the part number breakdown page at the end of each section.
- 8) Please contact us directly if you have any further problems.

XLR Connectors

AC Series XLR Cable Connectors



Features:

- Zinc Diecast Shell.
- Solder Bucket connections.
- “Jaws” Cable Retention System.
- Contact layouts in 3, 4, 5, 6A and 7.
- Precision machined or Stamped contacts.
- Leading first mate last break socket contact.
- Quick and easy assembly without screws – by hand or portable termination tool. (Part number T2860.)

Options: Stamped Contacts (3 contact only), Gold plated contacts, Large or Small Jaws Cable Clamp, Black Finish Shell, Bulk Pack, Coloured Boots / Backshells











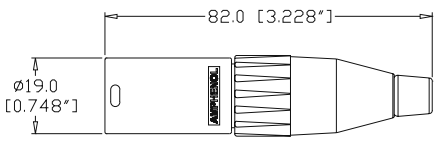

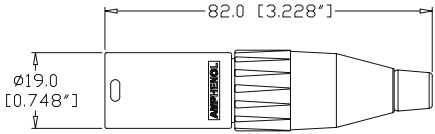

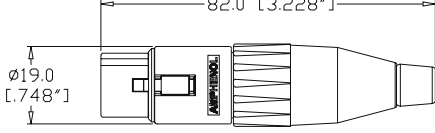

Part Number Breakdown: Page 15

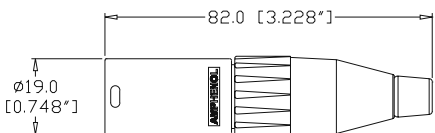
Specifications: Page 17

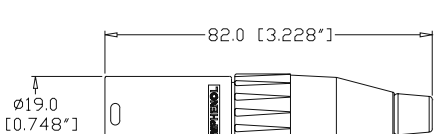
PRODUCT - FIGURE	DRAWING	DESCRIPTION	VARIATIONS	PART NUMBER
		XLR 3 pole male, Machined contacts, Nickel Finish, Jaws cable clamp	Standard	AC3MM
			Bulk Pack	AC3MM BULK
		XLR 3 pole male, Machined contacts, Black Finish, Jaws cable clamp	Standard	AC3MMB
			Gold Plated Contacts	AC3MMB-AU
			Bulk Pack	AC3MMB BULK
		XLR 3 pole male, Stamped contacts, Nickel Finish, Jaws cable clamp	Standard	AC3M
			Large Cable Clamp	AC3MJ
			Bulk Pack	AC3M BULK
		XLR 3 pole male, Stamped contacts, Black Finish, Jaws cable clamp	Standard	AC3MB
			Gold Plated Contacts	AC3MB-AU
			Large Cable Clamp	AC3MBJ
			Bulk Pack	AC3MB BULK
		XLR 3 pole female, Stamped contacts, Nickel Finish, Jaws cable clamp	Standard	AC3F
			Large Cable Clamp	AC3FJ
			Bulk Pack	AC3F BULK
		XLR 3 pole female, Stamped contacts, Black Finish, Jaws cable clamp	Standard	AC3FB
			Gold Plated Contacts	AC3FB-AU
			Large Cable Clamp	AC3FBJ
			Bulk Pack	AC3FB BULK

XLR Connectors

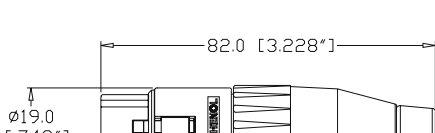
AC Series XLR Cable Connectors

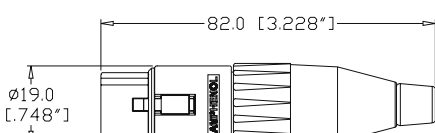
PRODUCT - FIGURE	DRAWING Dimensions in mm (inches)	DESCRIPTION	VARIATIONS	PART NUMBER
		XLR 4 pole male, Machined contacts, Nickel Finish, Jaws cable clamp	Standard	AC4M
			Large Cable Clamp	AC4MJ
			Bulk Pack	AC4M BULK
		XLR 4 pole male, Machined contacts, Black Finish, Jaws cable clamp	Standard	AC4MB
			Gold Plated Contacts	AC4MB-AU
			Large Cable Clamp	AC4MBJ
		XLR 4 pole female, Machined contacts, Nickel Finish, Jaws cable clamp	Standard	AC4F
			Large Cable Clamp	AC4FJ
			Bulk Pack	AC4F BULK
		XLR 4 pole female, Machined contacts, Black Finish, Jaws cable clamp	Standard	AC4FB
			Gold Plated Contacts	AC4FB-AU
			Large Cable Clamp	AC4FBJ
		XLR 5 pole male, Machined contacts, Nickel Finish, Jaws cable clamp	Standard	AC5M
			Large Cable Clamp	AC5MJ
			Bulk Pack	AC5M BULK
		XLR 5 pole male, Machined contacts, Black Finish, Jaws cable clamp	Standard	AC5MB
			Gold Plated Contacts	AC5MB-AU
			Large Cable Clamp	AC5MBJ
		XLR 5 pole female, Machined contacts, Nickel Finish, Jaws cable clamp	Standard	AC5F
			Large Cable Clamp	AC5FJ
			Bulk Pack	AC5F BULK
		XLR 5 pole female, Machined contacts, Black Finish, Jaws cable clamp	Standard	AC5FB
			Gold Plated Contacts	AC5FB-AU
			Large Cable Clamp	AC5FBJ
		XLR 5 pole female, Machined contacts, Black Finish, Jaws cable clamp	Bulk Pack	AC5FB BULK

XLR Connectors

AC Series XLR Cable Connectors

PRODUCT - FIGURE	DRAWING	DESCRIPTION	VARIATIONS	PART NUMBER
		XLR 6A pole male, Machined contacts, Nickel Finish, Jaws cable clamp	Standard	AC6AM
			Large Cable Clamp	AC6AMJ
			Bulk Pack	AC6AM BULK
		XLR 6A pole male, Machined contacts, Black Finish, Jaws cable clamp	Standard	AC6AMB
			Gold Plated Contacts	AC6AMB-AU
			Large Cable Clamp	AC6AMBJ
		XLR 6A pole female, Machined contacts, Nickel Finish, Jaws cable clamp	Standard	AC6AF
			Large Cable Clamp	AC6AFJ
			Bulk Pack	AC6AF BULK
		XLR 6A pole female, Machined contacts, Black Finish, Jaws cable clamp	Standard	AC6AFB
			Gold Plated Contacts	AC6AFB-AU
			Large Cable Clamp	AC6AFBJ
		XLR 7 pole male, Gold plated Machined contacts, Nickel Finish, Jaws cable clamp	Standard	AC7M
			Large Cable Clamp	AC7MJ
			Bulk Pack	AC7M BULK
		XLR 7 pole male, Gold plated Machined contacts, Black Finish, Jaws cable clamp	Standard	AC7MB
			Large Cable Clamp	AC7MBJ
			Bulk Pack	AC7MB BULK
		XLR 7 pole female, Gold plated Machined contacts, Nickel Finish, Jaws cable clamp	Standard	AC7F
			Large Cable Clamp	AC7FJ
			Bulk Pack	AC7F BULK
		XLR 7 pole female, Gold plated Machined contacts, Black Finish, Jaws cable clamp	Standard	AC7FB
			Large Cable Clamp	AC7FBJ
			Bulk Pack	AC7FB BULK

PART NUMBER BREAKDOWN

METAL SHELL TYPE - SOLDER

E. G. **AC3MMBJ-AU BULK**
AC (Series Prefix), **3** contacts, **Male**, **M**achined Contacts, **B**lack Polyester Finish,
J (Large Jaws),- **AU** (Gold Plated Contacts), **BULK** Packaged.

SERIES PREFIX	AC = Series Prefix
CONTACT LAYOUTS	3 = 3 Contacts 4 = 4 Contacts 5 = 5 Contacts 6A = 6 Contacts 7 = 7 Contacts
GENDER	F = Female Socket Contacts M = Male Pin Contacts
CONTACT¹	Blank = Stamped Contacts M = Machined Contacts G = Stamped Contacts, Ground Tag MG = Machined Contacts, Ground Tag (Applicable 3 male pin contacts, option M & MG only)
SHELL FINISH²	Blank = Nickel Plated Finish B = Black Polyester Finish
CABLE CLAMP	Blank = Standard Jaws 3mm - 6.5mm cable O.D. (0.118" to 0.255") J = Large Jaws 6.5mm - 8mm cable O.D. (0.255" to 0.314")
CONTACT PLATING³	Blank = Standard Plating (Silver or Tin) (Refer to Standard Data) AU = Gold Plated
PACKAGING	Blank = Individual Bags BULK = Bulk Packed

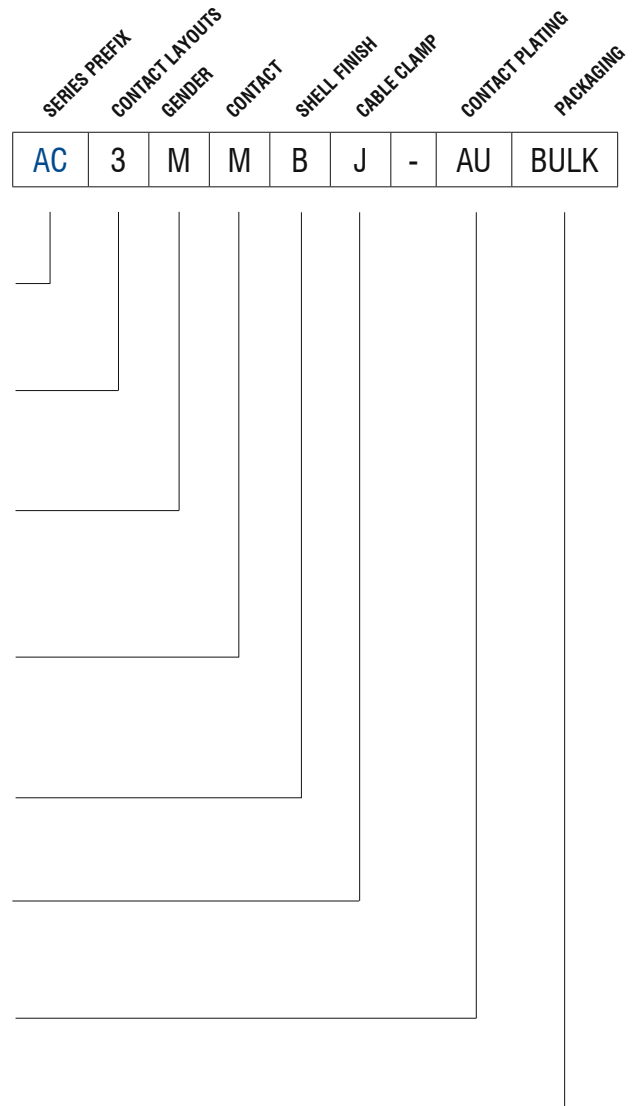

Note:

¹ 4 - 7 contact connectors have machined contacts and grounding as standard.

² Ground contacts are not supplied with the black polyester finish shell option.

³ 7 Contact is gold plated as standard.

⁴ All AC Series Connectors are available with optional colour coded boot / backshell. Refer to page 156 and simply add colour to end of part number. Example: AC3MM - RED

XLR Connectors

AC Series XLR Cable Connectors





Features:

- Thermoplastic Shell.
- Solder Bucket Connections.
- "Jaws" Cable Retention System.
- Stamped or Machined Contacts.
- Leading first mate last break socket contact.
- Quick and easy assembly without screws – by hand or portable termination tool. (Part number T2860.)

Options: Gold Plated Contacts, Stamped Contacts (3 Contact only), Bulk Pack, Coloured Boots / Backshells 3, 4, 5, 6A and 7 Contacts.

Specifications: [Page 17](#)

PRODUCT - FIGURE	DRAWING	DESCRIPTION	VARIATIONS	PART NUMBER
		XLR 3 pole male, Machined contacts, Thermoplastic shell, Jaws cable clamp	Standard	AC3MMCP
			Bulk Pack	AC3MMCP BULK
		XLR 3 pole male, Stamped contacts, Thermoplastic shell, Jaws cable clamp	Standard	AC3MCP
			Bulk Pack	AC3MCP BULK
		XLR 3 pole female, Stamped contacts, Thermoplastic shell, Jaws cable clamp	Standard	AC3FCP
			Bulk Pack	AC3FCP BULK

Note: Thermoplastic shell connectors are also available in 4 - 7 contact arrangements, please contact us for ordering code.

STANDARD DATA AC CABLE CONNECTORS

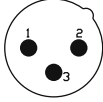
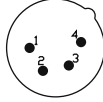
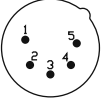
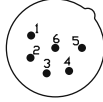
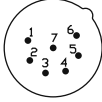
		VALUE				
GENERAL CHARACTERISTICS	Number of contacts	3	4	5	6A	7
	AC Series Contact Arrangements (Front view of pin inserts)					
	Termination	SOLDER				
	Max. Wire Gauge - Stranded wire: Solder	14AWG	16AWG	18AWG		20AWG
	Flammability rating (insulator plastics & housings)	UL94V-0				
	Environmental	Complies with EU RoHS 2 Directive 2011/65/EU				
ELECTRICAL CHARACTERISTICS	Service Voltage RMS	133V ¹				
	Test Voltage AC RMS	1400V				
	Current carrying capacity: Solder	15A	10A	7.5A		5A
	Typical Contact Resistance	≤3mΩ				
	Insulation Resistance	≥1GΩ				
CLIMATIC CHARACTERISTICS	Protection Class	IP40				
	Operating Temperature	-25 °C to +75 °C (-13°F to +167°F)				
MECHANICAL CHARACTERISTICS	Insertion and Withdrawal force	≥ 10N - ≤30N				
	Weight - Metal ²	36g (0.080lb)	37g (0.081lb)	38g (0.083lb)		
	Weight - Thermoplastic ²	18g (0.039lb)	19g (0.041lb)	20g (0.044lb)		
	Typical Cable retention force	22Kg to 44Kg (50lb to 100lb) - Dependent on cable material and diameter.				
	Cable O.D. range - JAWS clamp	Standard	3mm to 6.5mm (0.118" to 0.255")			
		Large	6.5mm to 8mm (0.255" to 0.314")			
	Mechanical Operations	1000 mating cycles				
MATERIALS	Connector shell - Metal	Diecast Zinc Alloy				
	Shell finish	Satin nickel or Black polyester				
	Connector shell - Thermoplastic	Thermoplastic, UL94V-0 Modified PPE Resin				
	Shell finish	Black				
	Insulators	UL94V-0 PBT Resin or Modified PPE Resin				
	Boot / Backshell	UL94V-0 Modified PPE Resin or Machined Brass				
	Finish	Black, other colours available - see page 156				
	Cable clamp (JAWS)	Standard Solder	UL94V-0 Modified PPO Resin (Black)			
	Large Solder	UL94V-0 Modified PPO Resin (Purple)				
Cable Bushing		Santoprene				
Male Contact (Solder / Plating)	Stamped	Phosphor Bronze / Silver or Gold (Optional)				
	Machined	Brass / Silver or Gold (Optional)				
Female Contact (Solder / Plating)	Stamped	Phosphor Bronze / Tin or Gold (Optional)				
	Machined	Brass / Silver or Gold (Optional)				

Rev 6 - 03/2015

¹ Not suitable for domestic applications above 50V

² Approximate weight only, does not include packaging. Please contact us for exact weight for shipping purposes.

XLR Connectors

AC/AX Series XLR Metal Chassis Mount Connectors



AC/AX SERIES XLR METAL CHASSIS MOUNT CONNECTORS

The metal chassis mount connectors are designed for the audio user where durability, reliability and strength across a wide range of applications are important. All products are manufactured to the highest quality standards and will withstand the harshest environments. This range complies with IEC268-12 and AES 14-1992 standards. CSA File Number 68598

Features

- The "D" size housing can be either front or rear mounted using the same panel cutout.
- The "P" size housing is the original wide flange front mounting XLR connector. "PN" is the original narrow flange front mounting male connector.
- A leading first mate last break socket contact is standard on all female connectors (Pin 1).
- Solder cup or Vertical PCB versions.
- Connectors are fitted with a grounding system for RFI shielding applications.
- Available in 3, 4, 5, 6A and 7 contact arrangements.
- Compatible with all other XLR brands.

Options

- Solder Bucket termination
- Vertical PCB contacts
- Zinc Diecast Shell - Satin Nickel Finish
- Zinc Diecast Shell - Black Polyester Finish
- Gold, Silver or Tin Plated Contacts
- Bulk Packaging
- Single Bag packs
- Precision machined contacts
- Cost effective stamped contacts on 3 pole
- Latchless versions (Non-Latching) (Female only)

Note: A ground tag is standard on all AC "Z" series connectors. Although the ground tag is intended for RFI shielding applications, Amphenol cannot guarantee its effectiveness in all cases.

The non-conductive Black polyester finish insulates the ground tag from the shell and should not be used in applications requiring ground contact to the shell.

Ordering Codes

We have listed the more common ordering codes in each section. For further options please refer to the part number breakdown charts. Please contact us if you need any further assistance.

Simple steps to guide you in using this catalogue

- 1) Identify the product group listed in Contents on page 1 and go directly to that page number.
- 2) Each product group cover page then details information and options available.
- 3) Refer to the product detail pages and identify the product you require pictorially.
- 4) Read the product description column for the products standard features.
- 5) Use variations column to determine your choice.
- 6) Identify part number.
- 7) In the event the particular option you require is not listed please refer to the part number breakdown page at the end of each section.
- 8) Please contact us directly if you have any further problems.

XLR Connectors

AC/AX Series XLR Metal Chassis Mount Connectors









Features:

- Zinc Diecast Shell.
- D size housing can be front or rear mounted using the same panel cutout.
- Solder Bucket connections.
- Vertical PCB mounting.
- Precision machined or Stamped contacts (3 pin only).
- Leading first mate last break socket contact.
- Positive latch lock system.
- M3 threaded holes (Optional).

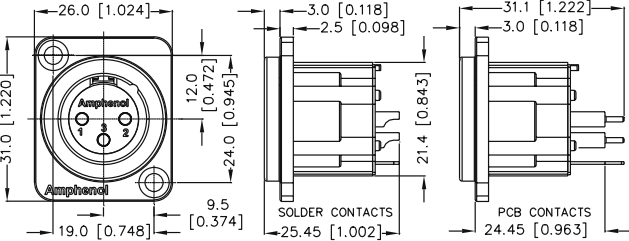
Options: Stamped contacts (3 contact only), Gold plated contacts, Vertical PCB contacts, Black finish, Non-Latching (Female only), Bulk Pack.

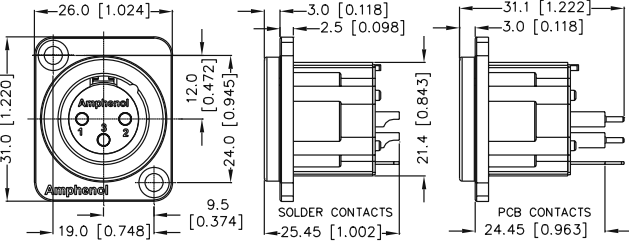

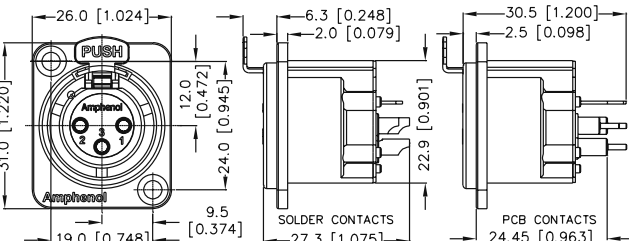

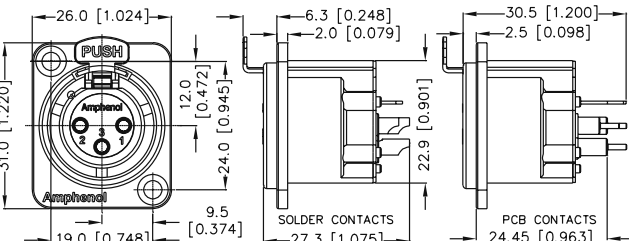

Part Number Breakdown: Page 22

Specifications: Page 28

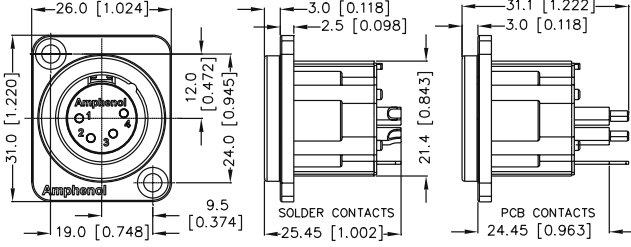
PRODUCT	DRAWING Dimensions in mm (inches)	DESCRIPTION	VARIATIONS	PART NO.
		XLR 3 pole male, D Flange, Machined contacts, Nickel Finish	Standard	AX3MD
		M3 Threaded Holes	AX3MD-M3	
		Vertical PCB	AX3MDV	
		M3 Threaded Holes	AX3MDV-M3	
		XLR 3 pole male, D Flange, Machined contacts, Black Finish	Standard	AX3MDB
		M3 Threaded Holes	AX3MDB-M3	
		Gold Plated Contacts	AX3MDB-AU	
		Vertical PCB	AX3MDVB	
		M3 Threaded Holes	AX3MDVB-M3	
		XLR 3 pole female, D Flange, Stamped contacts, Nickel Finish	Standard	AX3FD
		M3 Threaded Holes	AX3FD-M3	
		XLR 3 pole female, D Flange, Stamped contacts, Black Finish	Standard	AX3FDB
		M3 Threaded Holes	AX3FDB-M3	
		Gold Plated Contacts	AX3FDB-AU	

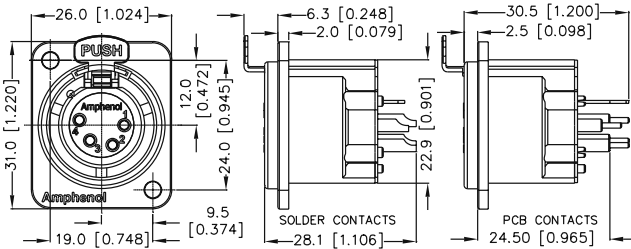

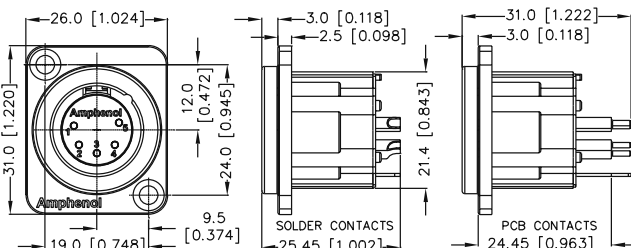





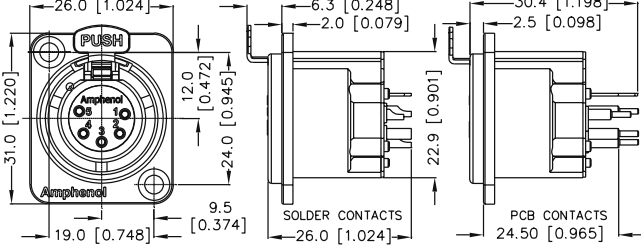

XLR Connectors

AC/AX Series XLR Metal Chassis Mount Connectors

PRODUCT	DRAWING Dimensions in mm (inches)	DESCRIPTION	VARIATIONS	PART NO.	
	 <p>Technical drawing showing front, side, and PCB views of XLR connectors with dimensions in mm and inches.</p>	XLR 4 pole male, D Flange, Machined contacts, Nickel Finish	Standard M3 Threaded Holes	AX4MD AX4MD-M3	
		Vertical PCB	AX4MDV M3 Threaded Holes		
		XLR 4 pole male, D Flange, Machined contacts, Black Finish	Standard Gold Plated Contacts	AX4MDB AX4MDB-AU	
		Vertical PCB	AX4MDVB		
		 <p>Technical drawing showing front, side, and PCB views of XLR connectors with dimensions in mm and inches.</p>	XLR 4 pole female, D Flange, Machined contacts, Nickel Finish	Standard M3 Threaded Holes	AX4FD AX4FD-M3
			Vertical PCB	AX4FDV M3 Threaded Holes	
	XLR 4 pole female, D Flange, Machined contacts, Black Finish		Standard Gold Plated Contacts	AX4FDB AX4FDB-AU	
	Vertical PCB		AX4FDBV		
	 <p>Technical drawing showing front, side, and PCB views of XLR connectors with dimensions in mm and inches.</p>		XLR 5 pole male, D Flange, Machined contacts, Nickel Finish	Standard M3 Threaded Holes	AX5MD AX5MD-M3
			Vertical PCB	AX5MDV M3 Threaded Holes	
		XLR 5 pole male, D Flange, Machined contacts, Black Finish	Standard Gold Plated Contacts	AX5MDB AX5MDB-AU	
		Vertical PCB	AX5MDVB		

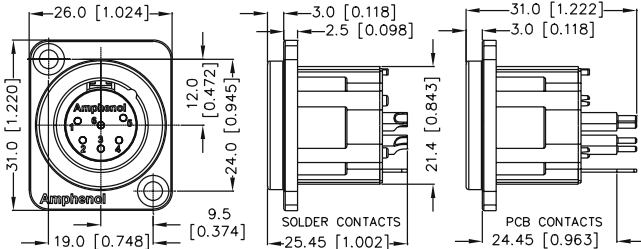
XLR Connectors

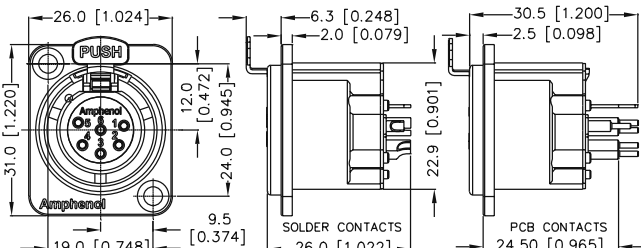
AC/AX Series XLR Metal Chassis Mount Connectors

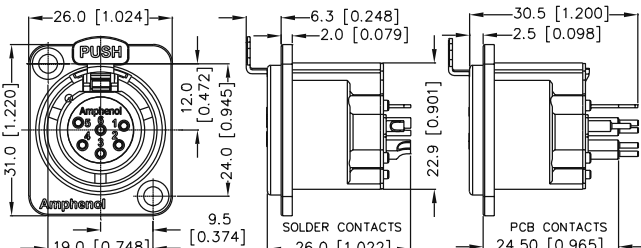
PRODUCT	DRAWING Dimensions in mm (inches)	DESCRIPTION	VARIATIONS	PART NO.
		XLR 5 pole female, D Flange, Machined contacts, Nickel Finish	Standard	AX5FD
			M3 Threaded Holes	AX5FD-M3
			Vertical PCB	AX5FDV
			M3 Threaded Holes	AX5FDV-M3
		XLR 5 pole female, D Flange, Machined contacts, Black Finish	Standard	AX4FDB
			Gold Plated Contacts	AX4FDB-AU
			Vertical PCB	AX4FDVB
		XLR 6A pole male, D Flange, Machined contacts, Nickel Finish	Standard	AX6AMD
			M3 Threaded Holes	AX6AMD-M3
			Vertical PCB	AX6AMDV
			M3 Threaded Holes	AX6AMDV-M3
		XLR 6A pole male, D Flange, Machined contacts, Black Finish	Standard	AX6AMDB
			Gold Plated Contacts	AX6AMDB-AU
			Vertical PCB	AX6AMDVB
		XLR 6A pole female, D Flange, Machined contacts, Nickel Finish	Standard	AX6AFD
			M3 Threaded Holes	AX6AFD-M3
			Vertical PCB	AX6AFDV
			M3 Threaded Holes	AX6AFDV-M3
		XLR 6A pole female, D Flange, Machined contacts, Black Finish	Standard	AX6AFDB
			Gold Plated Contacts	AX6AFDB-AU
			Vertical PCB	AX6AFDVB

XLR Connectors

AC/AX Series XLR Metal Chassis Mount Connectors

PART NUMBER BREAKDOWN

METAL TYPE FLANGE

E. G. **AX3MDVB-AU-M3 BULK**
AX (Series Prefix), **3** contacts, **M**ale, **D** Small Flange, **V**ertical PCB Contact,
Black Polyester Finish, - **AU** (Gold Plated Contacts), - **M3** Mounted Holes,
BULK Packaged.

SERIES PREFIX	AX	=	Series Prefix
CONTACT LAYOUTS	3	=	3 Contacts
	4	=	4 Contacts
	5	=	5 Contacts
	6A	=	6 Contacts
GENDER	F	=	Female Socket Contacts
	M	=	Male Pin Contacts
SHELL STYLE	D	=	Small Flange (front or rear mounting)
SHELL SERIES	Blank	=	Solder Bucket
	V	=	Vertical PCB Contact
SHELL FINISH¹	Blank	=	Nickel Plated Finish
	B	=	Black Polyester Finish
CONTACT PLATING²	Blank	=	Standard Plating
	AU	=	Gold Plated
MOUNTING HOLES	Blank	=	Through Holes
	M3	=	M3 Threaded Holes
PACKAGING	Blank	=	Individual Bags
	BULK	=	Bulk Packed

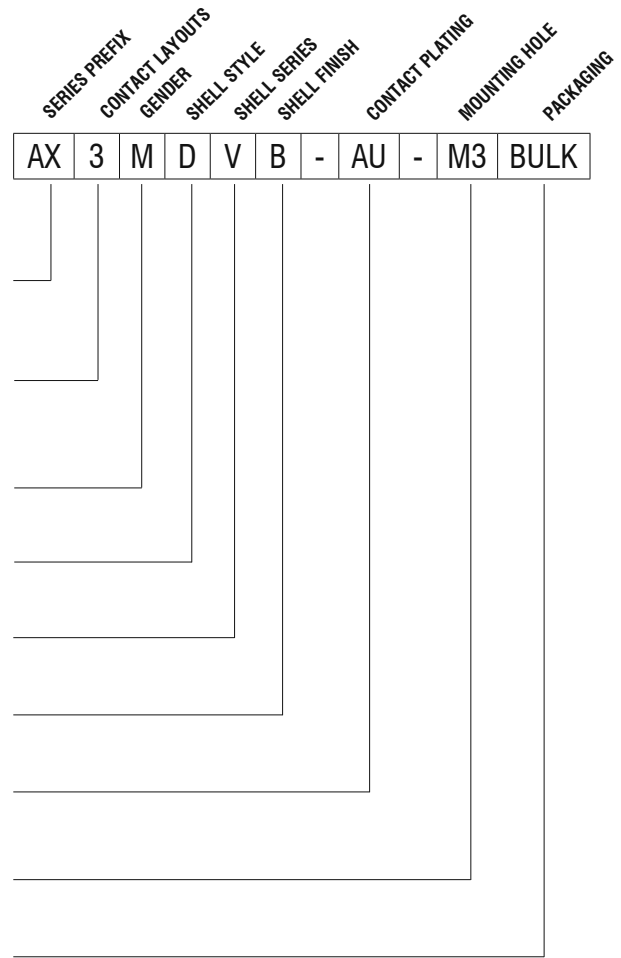

Note:

¹ Ground contacts are not supplied with the black polyester finish shell option.

³ Non-Latching Versions (Female) available - Please contact us for part number options.

XLR Connectors

AC/AX Series XLR Metal Chassis Mount Connectors



Features:

- Zinc Diecast Shell.
- D size housing can be front or rear mounted using the same panel cutout.
- Solder Bucket connections.
- Precision machined or Stamped contacts (3 pin only).
- Leading first mate last break socket contact.
- Positive latch lock system.

Options: Stamped contacts (3 contact only), Gold plated contacts, Black finish, Non-Latching (Female only), Bulk Pack.

Part Number Breakdown: [Page 27](#)

Specifications: [Page 28](#)











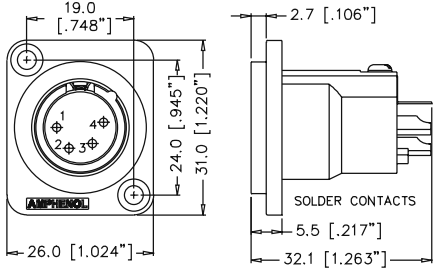

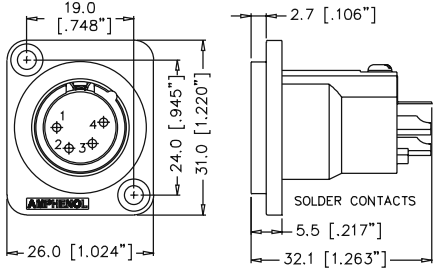

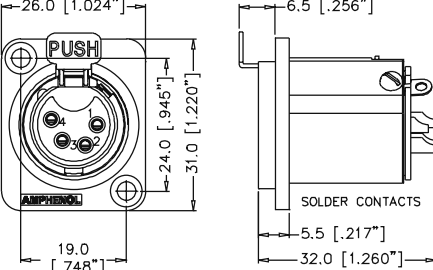
PCB Footprints: [Page 29](#)

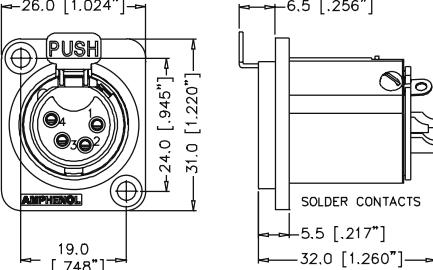
Panel Cutouts: [Page 29](#)

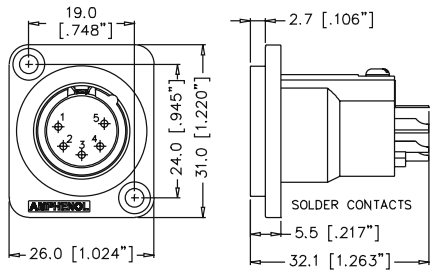
PRODUCT - FIGURE	DRAWING	Dimensions in mm (inches)	DESCRIPTION	VARIATIONS	PART NUMBER
	<p>19.0 [.748"] 24.0 [.945"] 31.0 [1.220"] 26.0 [1.024"] 2.7 [.106"] 5.5 [.217"] 32.1 [1.263"] SOLDER CONTACTS</p>	<p>XLR 3 pole male, D Flange, Machined contacts, Nickel Finish</p>	Standard	AC3MMDZ	
			Bulk Pack	AC3MMDZ BULK	
	<p>19.0 [.748"] 24.0 [.945"] 31.0 [1.220"] 26.0 [1.024"] 2.7 [.106"] 5.5 [.217"] 32.1 [1.263"] SOLDER CONTACTS</p>	<p>XLR 3 pole male, D Flange, Machined contacts, Black Finish</p>	Standard	AC3MMDZB	
			Gold Plated Contacts	AC3MMDZB-AU	
	<p>19.0 [.748"] 24.0 [.945"] 31.0 [1.220"] 26.0 [1.024"] 2.7 [.106"] 5.5 [.217"] 32.1 [1.263"] SOLDER CONTACTS</p>	<p>XLR 3 pole male, D Flange, Stamped contacts, Nickel Finish</p>	Standard	AC3MDZ	
			Bulk Pack	AC3MDZ BULK	
	<p>19.0 [.748"] 24.0 [.945"] 31.0 [1.220"] 26.0 [1.024"] 2.7 [.106"] 5.5 [.217"] 32.1 [1.263"] SOLDER CONTACTS</p>	<p>XLR 3 pole male, D Flange, Stamped contacts, Black Finish</p>	Standard	AC3MDZB	
			Gold Plated Contacts	AC3MDZB-AU	
	<p>26.0 [1.024"] 19.0 [.748"] 24.0 [.944"] 31.0 [1.220"] 6.5 [.256"] 5.5 [.217"] 33.5 [1.319"] SOLDER CONTACTS</p>	<p>XLR 3 pole female, D Flange, Stamped contacts, Nickel Finish</p>	Standard	AC3FDZ	
			Bulk Pack	AC3FDZ BULK	
	<p>26.0 [1.024"] 19.0 [.748"] 24.0 [.944"] 31.0 [1.220"] 6.5 [.256"] 5.5 [.217"] 33.5 [1.319"] SOLDER CONTACTS</p>	<p>XLR 3 pole female, D Flange, Stamped contacts, Black Finish</p>	Standard	AC3FDZB	
			Gold Plated Contacts	AC3FDZB-AU	

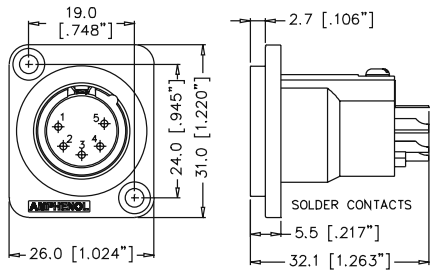

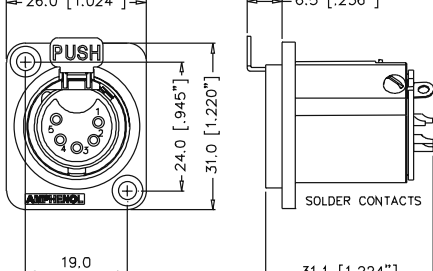

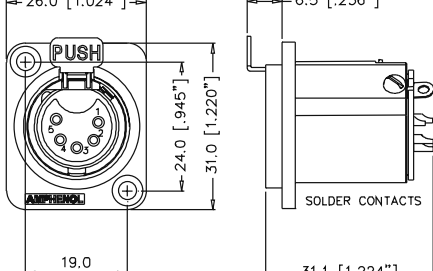





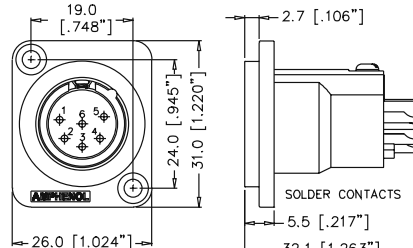

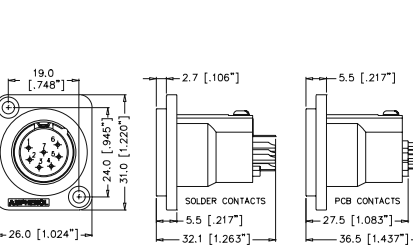

XLR Connectors

AC/AX Series XLR Metal Chassis Mount Connectors

PRODUCT - FIGURE	DRAWING	Dimensions in mm (inches)	DESCRIPTION	VARIATIONS	PART NUMBER
		<p>2.7 [.106"]</p> <p>SOLDER CONTACTS</p> <p>5.5 [.217"]</p> <p>32.1 [1.263"]</p>	<p>XLR 4 pole male, D Flange, Machined contacts, Nickel Finish</p>	Standard	AC4MDZ
				Bulk Pack	AC4MDZ BULK
		<p>2.7 [.106"]</p> <p>SOLDER CONTACTS</p> <p>5.5 [.217"]</p> <p>32.1 [1.263"]</p>	<p>XLR 4 pole male, D Flange, Machined contacts, Black Finish</p>	Standard	AC4MDZB
				Gold Plated Contacts	AC4MDZB-AU
		<p>6.5 [.256"]</p> <p>SOLDER CONTACTS</p> <p>5.5 [.217"]</p> <p>32.0 [1.260"]</p>	<p>XLR 4 pole female, D Flange, Machined contacts, Nickel Finish</p>	Standard	AC4FDZ
				Bulk Pack	AC4FDZ BULK
		<p>6.5 [.256"]</p> <p>SOLDER CONTACTS</p> <p>5.5 [.217"]</p> <p>32.0 [1.260"]</p>	<p>XLR 4 pole female, D Flange, Machined contacts, Black Finish</p>	Standard	AC4FDZB
				Gold Plated Contacts	AC4FDZB-AU
		<p>2.7 [.106"]</p> <p>SOLDER CONTACTS</p> <p>5.5 [.217"]</p> <p>32.1 [1.263"]</p>	<p>XLR 5 pole male, D Flange, Machined contacts, Nickel Finish</p>	Standard	AC5MDZ
				Bulk Pack	AC5MDZ BULK
		<p>2.7 [.106"]</p> <p>SOLDER CONTACTS</p> <p>5.5 [.217"]</p> <p>32.1 [1.263"]</p>	<p>XLR 5 pole male, D Flange, Machined contacts, Black Finish</p>	Standard	AC5MDZB
				Gold Plated Contacts	AC5MDZB-AU
		<p>6.5 [.256"]</p> <p>SOLDER CONTACTS</p> <p>5.5 [.217"]</p> <p>31.1 [1.224"]</p>	<p>XLR 5 pole female, D Flange, Machined contacts, Nickel Finish</p>	Standard	AC5FDZ
				Bulk Pack	AC5FDZ BULK
		<p>6.5 [.256"]</p> <p>SOLDER CONTACTS</p> <p>5.5 [.217"]</p> <p>31.1 [1.224"]</p>	<p>XLR 5 pole female, D Flange, Machined contacts, Black Finish</p>	Standard	AC5FDZB
				Gold Plated Contacts	AC5FDZB-AU

XLR Connectors

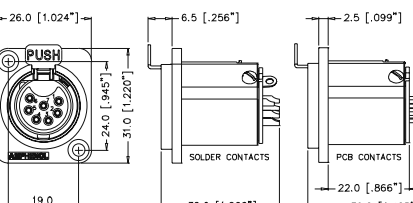
AC/AX Series XLR Metal Chassis Mount Connectors

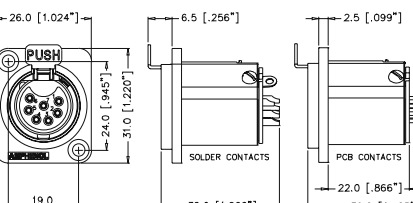
PRODUCT - FIGURE	DRAWING	Dimensions in mm (inches)	DESCRIPTION	VARIATIONS	PART NUMBER
			XLR 6A pole male, D Flange, Machined contacts, Nickel Finish	Standard	AC6AMDZ
				Bulk Pack	AC6AMDZ BULK
			XLR 6A pole male, D Flange, Machined contacts, Black Finish	Standard	AC6AMDZB
				Gold Plated Contacts	AC6AMDZB-AU
			XLR 6A pole female, D Flange, Machined contacts, Nickel Finish	Standard	AC6AFDZ
				Bulk Pack	AC6AFDZ BULK
			XLR 6A pole female, D Flange, Machined contacts, Black Finish	Standard	AC6AFDZB
				Gold Plated Contacts	AC6AFDZB-AU
			XLR 7 pole male, D Flange, Gold Plated Machined contacts, Nickel Finish	Standard	AC7MDZ
				Vertical PCB	AC7MDZV
				Bulk Pack	AC7MDZ BULK
			XLR 7 pole male, D Flange, Gold Plated Machined contacts, Black Finish	Standard	AC7MDZB
				Vertical PCB	AC7MDZVB
			XLR 7 pole female, D Flange, Gold Plated Machined contacts, Nickel Finish	Standard	AC7FDZ
				Vertical PCB	AC7FDZV
				Bulk Pack	AC7FDZ BULK
			XLR 7 pole female, D Flange, Gold Plated Machined contacts, Black Finish	Standard	AC7FDZB
				Vertical PCB	AC7FDZVB

XLR Connectors

AC/AX Series XLR Metal Chassis Mount Connectors



Features:

- Zinc Diecast shell.
- The P size housing is the original wide flange front mounting XLR connector. PN is the original narrow, front mounting male connector.
- Solder Bucket connections.
- Precision Machined or Stamped contacts (3 pin only).
- Leading first mate last break socket contact.
- Positive latch lock system.

Options: Stamped contacts (3 contact only), Gold plated contacts, Black Finish, Non-Latching (Female only), Bulk Pack.

Part Number Breakdown: Page 22 Specifications: Page 28
PCB Footprints: Page 29 Panel Cutouts: Page 29

PRODUCT - FIGURE	DRAWING	Dimensions in mm (inches)	DESCRIPTION	POLES	PART NUMBER
			XLR male, Narrow flange, Machined contacts	3	AC3MMPNZ
			XLR male, Narrow flange, Stamped contacts,	3 4 5 6 7	AC3MPNZ AC4MPNZ AC5MPNZ AC6AMPNZ AC7MPNZ
			XLR male, Wide flange, Machined contacts	3	AC3MMP
			XLR male, Wide flange, Stamped contacts	3 4 5 6 7	AC3MP AC4MP AC5MP AC6AMP AC7MP
			XLR female, Wide flange, Stamped contacts	3 4 5 6 7	AC3FPZ AC4FPZ AC5FPZ AC6AFPZ AC7FPZ

*Black finish available on special request please contact factory.

PART NUMBER BREAKDOWN

METAL TYPE FLANGE

E. G. **AC3MMPNZVB-AU BULK**
AC (Series Prefix), **3** contacts, **Male**, **Machined Contacts**, **PN** (Narrow Flange), **Z** (Metal Chassis Series), **Black Polyester Finish**, **- AU** (Gold Plated Contacts), **Bulk** Packaged.

SERIES PREFIX	AC	=	Series Prefix
CONTACT LAYOUTS	3	=	3 Contacts
	4	=	4 Contacts
	5	=	5 Contacts
	6A	=	6 Contacts
	7	=	7 Contacts
GENDER	F	=	Female Socket Contacts
	M	=	Male Pin Contacts
MACHINED CONTACTS¹	Blank	=	Stamped Contacts
	M	=	Machined Contacts (Applicable 3 male pin contacts only)
SHELL STYLE	D	=	Small Flange (front or rear mounting)
	P	=	Large Shell with Wide Flange
	PN	=	Large Shell with Narrow Flange (male only)
SHELL SERIES	Blank	=	Male P Shell Style Only
	Z	=	Metal Chassis Series
SHELL FINISH²	Blank	=	Nickel Plated Finish
	B	=	Black Polyester Finish
CONTACT PLATING³	Blank	=	Standard Plating (Silver or Tin - refer to Standard Data)
	AU	=	Gold Plated
PACKAGING	Blank	=	Individual Bags
	BULK	=	Bulk Packed

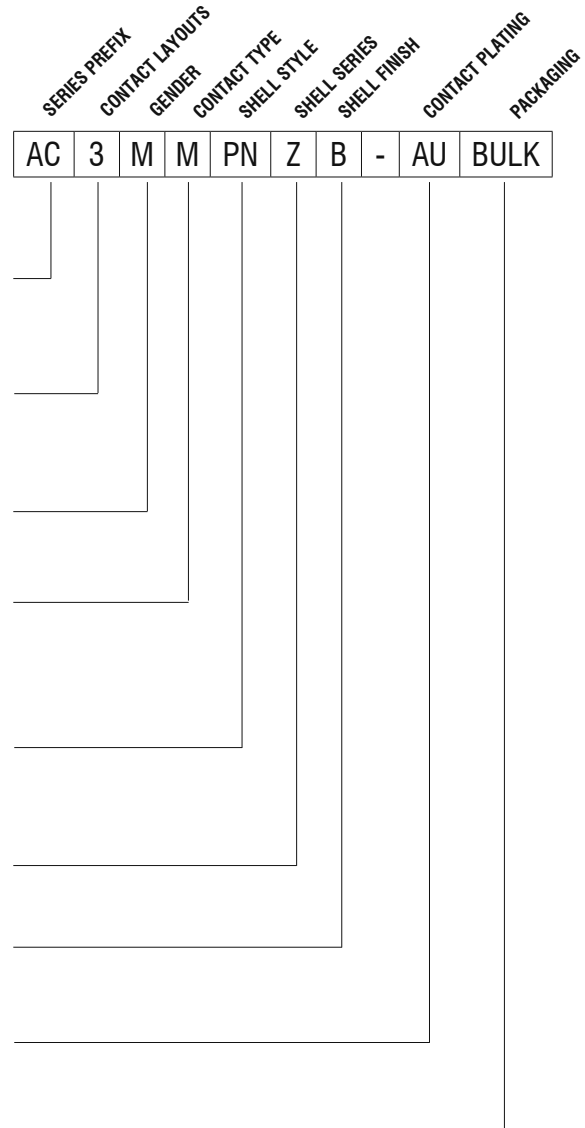

Note:

¹ 4 - 7 contact connectors have machined contacts and grounding as standard. They are not available in stamped contacts.

² Ground contacts are not supplied with the black polyester finish shell option.

³ 7 Contact is gold plated as standard.

⁴ Non-Latching Versions (Female) available - Please contact us for part number options.

XLR Connectors

AC/AX Series XLR Metal Chassis Mount Connectors

STANDARD DATA AC / AX SERIES CHASSIS - METAL “Z”

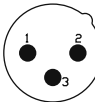
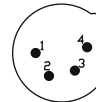
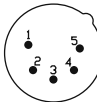
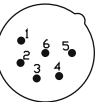
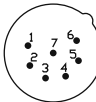
		VALUE				
GENERAL CHARACTERISTICS	Number of contacts	3	4	5	6A	7
	Contact Arrangement (Front view of pin inserts)					
	Termination	Solder Bucket / Printed Circuit Board (PCB)				
	Max. Wire Gauge - Stranded wire:					
	Solder	14AWG	16AWG	18AWG	18AWG	20AWG
	Printed Circuit Board - PCB	N/A	N/A	N/A	N/A	N/A
Flammability rating of plastics	UL94V-0					
Environmental	Complies with EU RoHS 2 Directive 2011/65/EU					
ELECTRICAL CHARACTERISTICS	Service Voltage RMS	133V ¹⁾				
	Test Voltage AC RMS	1400V				
	Current carrying capacity:					
	Solder	15A	10A	7.5A	7.5A	5A
	Printed Circuit Board (PCB)	15A	10A	7.5A	7.5A	5A
	Typical Contact Resistance	≤3mΩ				
Insulation Resistance	≥1000MΩ					
CLIMATIC CHARACTERISTICS	Protection Class	IP40				
	Operating Temperature	-25 °C to +75 °C (-13°F to +167°F)				
MECHANICAL CHARACTERISTICS	Weight - Metal ²⁾	31g (0.068lb)	32g (0.070lb)	33g (0.072lb)	33g (0.072lb)	33g (0.072lb)
	Mechanical Operations	1000 mating cycles				
MATERIALS	Connector Shell	Diecast Zinc Alloy				
	Shell Finish	Satin Nickel or Black Polyester				
	Insulators	PA66 30% Glass Filled Resin				
	Male Contact					
	Stamped Solder and PCB-(Material/Plating)	Phosphor Bronze / Silver or Gold (optional)				
	Machined Solder-(Material/Plating)	Brass / Silver or Gold (optional)				
	Female Contact					
Stamped Solder and PCB-(Material/Plating)	Phosphor Bronze / Tin or Gold (optional)					
Machined Solder-(Material/Plating)	Brass / Silver or Gold (Optional)					

Rev 4 - 02/2020

¹⁾ Not suitable for domestic applications above 50V

²⁾ Approximate weight only, does not include packaging. Please contact us for exact weight for shipping purposes.

AC / AX SERIES CHASSIS METAL "Z"

PCB FOOTPRINTS STRAIGHT (V) CONNECTOR SIDE OF PCB

○ $\varnothing 1.2\text{mm}(.05") + \text{Panel Cutout CL}$

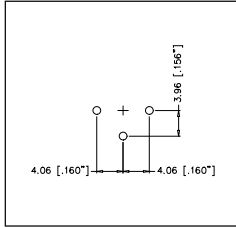

AC3MM*ZV

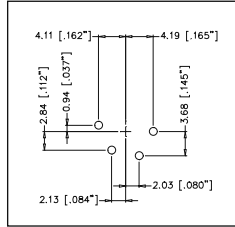

AC4F*ZV

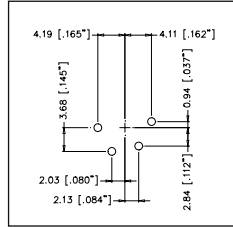

AC4M*ZV

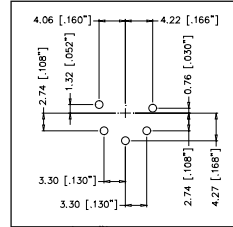

AC5F*ZV

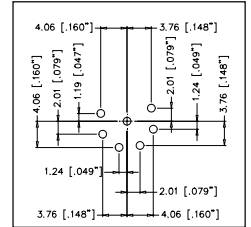

AC7M*ZV

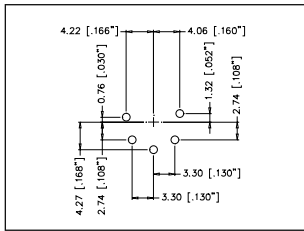

AC5M*ZV

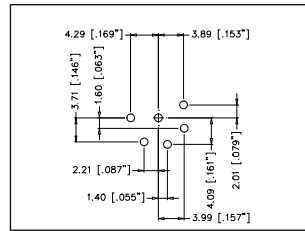

AC6AF*ZV

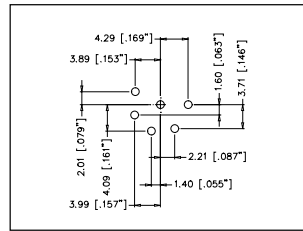

AC6AM*ZV

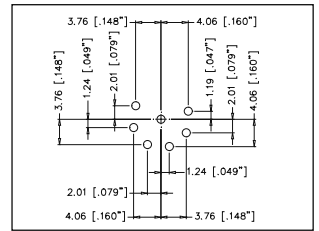

AC7F*ZV

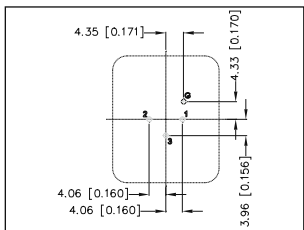

AX3FD

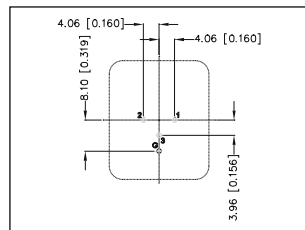

AX3MD

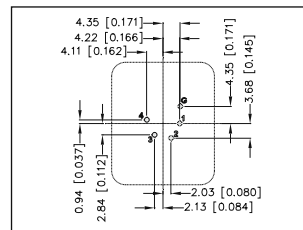

AX4FD

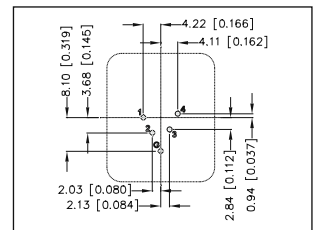

AX4MD

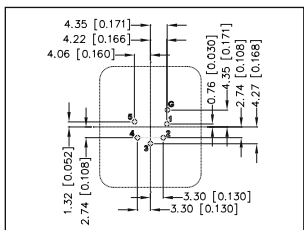

AX5FD

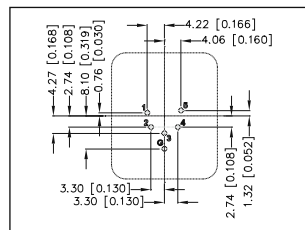

AX5MD

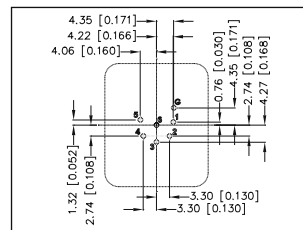

AX6AFD

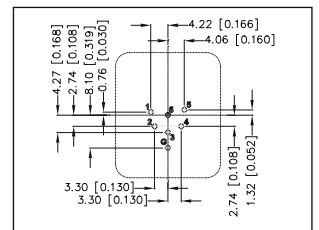

AX6AMD

PANEL CUTOUT DIMENSIONS FRONT VIEW

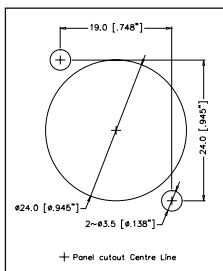

AC*FDZ / AX*FD

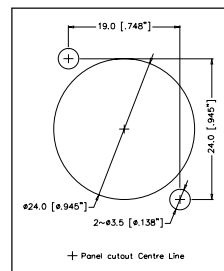

AC*MDZ / AX*MD

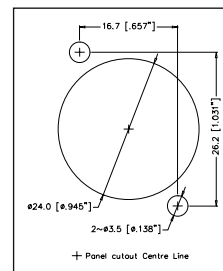

AC*FPZ

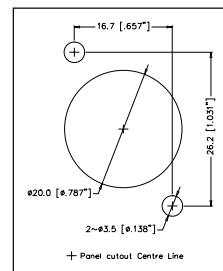



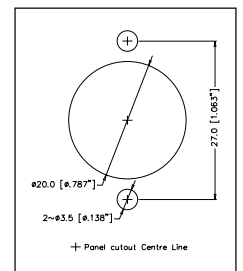

AC*MP



AC*MPNZ







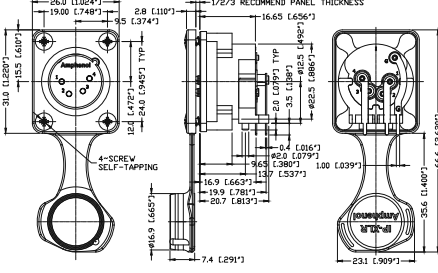

XLR Connectors

XLR IP65 Connectors

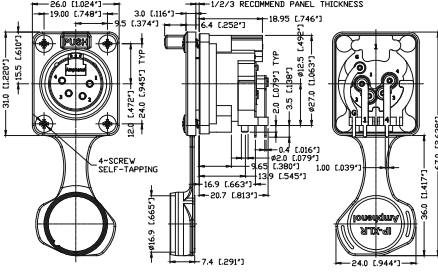
PRODUCT - FIGURE	DRAWING	Dimensions in mm (inches)	DESCRIPTION	VARIATIONS	PART NUMBER
		<p>1/2/3 RECOMMEND PANEL THICKNESS</p> <p>18.95 (0.746\"/> </p>	<p>XLR 3 pole female chassis with protective cap , IP65, Horizontal PCB, Rear mount</p>	Panel 1.0mm to 1.5mm	AXS3FPH
				Panel 1.5mm to 2mm	AXS3FP1H
				Panel 2mm to 3mm	AXS3FP2H
		<p>1/2/3 RECOMMEND PANEL THICKNESS</p> <p>16.65 (0.656\"/> </p>	<p>XLR 3 pole male chassis with protective cap , IP65, Vertical PCB, Rear mount</p>	Panel 1.0mm to 1.5mm	AXS3MPV
				Panel 1.5mm to 2mm	AXS3MP1V
				Panel 2mm to 3mm	AXS3MP2V
		<p>1/2/3 RECOMMEND PANEL THICKNESS</p> <p>18.95 (0.746\"/> </p>	<p>XLR 3 pole female chassis with protective cap , IP65, Vertical PCB, Rear mount</p>	Panel 1.0mm to 1.5mm	AXS3FPV
				Panel 1.5mm to 2mm	AXS3FP1V
				Panel 2mm to 3mm	AXS3FP2V
		<p>1/2/3 RECOMMEND PANEL THICKNESS</p> <p>16.65 (0.656\"/> </p>	<p>XLR 4 pole male chassis with protective cap , IP65, Solder bucket, Rear mount</p>	Panel 1.0mm to 1.5mm	AXS4MP
				Panel 1.5mm to 2mm	AXS4MP1
				Panel 2mm to 3mm	AXS4MP2
		<p>1/2/3 RECOMMEND PANEL THICKNESS</p> <p>18.95 (0.746\"/> </p>	<p>XLR 4 pole female chassis with protective cap , IP65, Solder bucket, Rear mount</p>	Panel 1.0mm to 1.5mm	AXS4FP
				Panel 1.5mm to 2mm	AXS4FP1
				Panel 2mm to 3mm	AXS4FP2

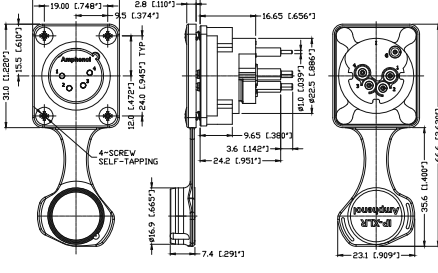
XLR Connectors

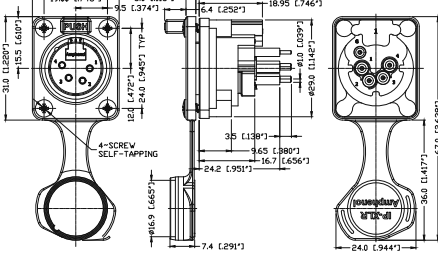
XLR IP65 Connectors

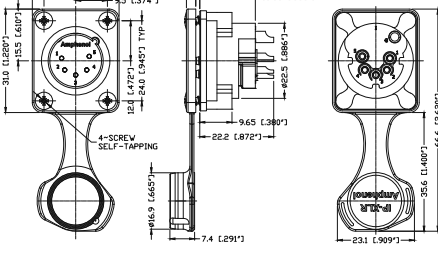
PRODUCT - FIGURE	DRAWING Dimensions in mm (inches)	DESCRIPTION	VARIATIONS	PART NUMBER
		XLR 4 pole male chassis with protective cap , IP65, Horizontal PCB, Rear mount	Panel 1.0mm to 1.5mm Panel 1.5mm to 2mm Panel 2mm to 3mm	AXS4MPH AXS4MP1H AXS4MP2H
		XLR 4 pole female chassis with protective cap , IP65, Horizontal PCB, Rear mount	Panel 1.0mm to 1.5mm Panel 1.5mm to 2mm Panel 2mm to 3mm	AXS4FPH AXS4FP1H AXS4FP2H
		XLR 4 pole male chassis with protective cap , IP65, Vertical PCB, Rear mount	Panel 1.0mm to 1.5mm Panel 1.5mm to 2mm Panel 2mm to 3mm	AXS4MPV AXS4MP1V AXS4MP2V
		XLR 4 pole female chassis with protective cap , IP65, Vertical PCB, Rear mount	Panel 1.0mm to 1.5mm Panel 1.5mm to 2mm Panel 2mm to 3mm	AXS4FPV AXS4FP1V AXS4FP2V
		XLR 5 pole male chassis with protective cap , IP65, Solder bucket, Rear mount	Panel 1.0mm to 1.5mm Panel 1.5mm to 2mm Panel 2mm to 3mm	AXS5MP AXS5MP1 AXS5MP2

XLR Connectors

XLR IP65 Connectors

PART NUMBER BREAKDOWN

CHASSIS CONNECTORS

E. G. **AXS3MP1V**
AXS (Series Prefix), **3** contacts, **Male**, **P1** (Thermoplastic 1.5mm to 2mm (Rear Mounting)), **V** (Vertical Mount- PCB Thru Hole)

SERIES PREFIX	AXS	=	Sealed IP65 with cap
	AXP	=	Sealed IP65 no cap
CONTACT LAYOUTS	3	=	3 Contacts
	4	=	4 Contacts
	5	=	5 Contacts
	6A	=	6 Contacts
GENDER	F	=	Socket receptacle housing
	M	=	Pin plug housing
SHELL SIZE	P	=	Thermoplastic 1mm to 1.5mm (Rear Mounting)
	P1	=	Thermoplastic 1.5mm to 2mm (Rear Mounting)
	P2	=	Thermoplastic 2mm to 3mm (Rear Mounting)
TERMINATION	Blank	=	Solder buckets
	H	=	Horizontal Mount (PCB thru hole)
	V	=	Vertical Mount (PCB thru hole)
SHELL MATERIAL / FINISH	Thermoplastic Black		
CONTACT PLATING	Blank	=	Standard
	AU	=	Gold plated
PACKAGING	Blank	=	Individual Bags
	BULK	=	Bulk Packed

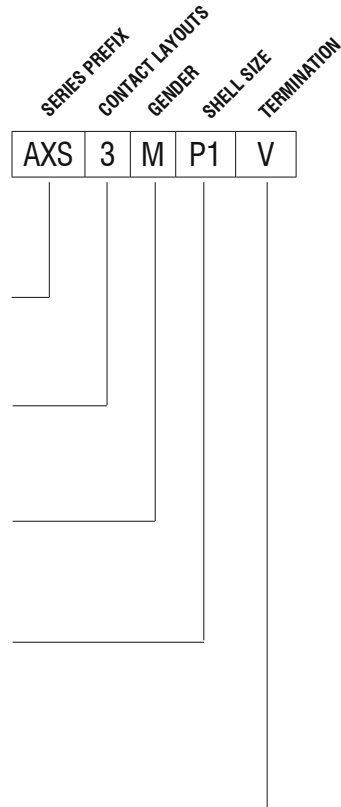

STANDARD DATA AX SERIES CHASSIS - IP65

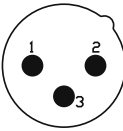
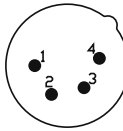
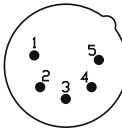
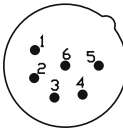
		VALUE			
GENERAL CHARACTERISTICS	Number of contacts	3	4	5	6A Available
	Contact Arrangement (Front view of pin inserts)				
	Termination	Solder Bucket / Printed Circuit Board (PCB)			
	Max. Wire Gauge - Stranded wire: Solder Printed Circuit Board - PCB	14AWG N/A	16AWG N/A	18AWG N/A	18AWG N/A
	Flammability rating of plastics & rubber	UL94V-0			
	Environmental	Complies with EU RoHS 2 Directive 2011/65/EU			
ELECTRICAL CHARACTERISTICS	Service Voltage RMS	133V ¹⁾			
	Test Voltage AC RMS	1400V			
	Current carrying capacity: Solder Printed Circuit Board (PCB)	15A 15A	10A 10A	7.5A 7.5A	7.5A 7.5A
	Typical Contact Resistance	≤3mΩ			
	Insulation Resistance	≥1000MΩ			
CLIMATIC CHARACTERISTICS	Protection Class	IP65			
	Operating Temperature	-25°C to +75°C (-13°F to +167°F)			
MECHANICAL CHARACTERISTICS	Weight ²⁾	31g (0.068lb)	32g (0.070lb)	33g (0.072lb)	33g (0.072lb)
	Mechanical Operations	1000 mating cycles			
MATERIALS	Connector Flange Finish	Rubber Black / Stainless Steel			
	Insulators	PA66 30% Glass Filled Resin			
	Male Contact Machined Solder and PCB-(Material/Plating)	Brass / Tin or Gold (Optional)			
	Female Contact Machined Solder and PCB-(Material/Plating)	Brass / Tin or Gold (Optional)			

Rev 2 - 10/2024

¹⁾Not suitable for domestic applications above 50V

²⁾Approximate weight only, does not include packaging. Please contact us for exact weight for shipping purposes.

XLR Connectors

XLNet IP65 Range



XLRNET IP65 RANGE

Part Number Breakdown: Page 39

PRODUCT - FIGURE	DRAWING	Dimensions in mm (inches)	DESCRIPTION	VARIATIONS	PART NUMBER
		26.0 [1.024"] 19.0 [0.748"] 10.1 [0.398"] 6.9 [0.272"] 24.0 [0.945"] #24.0 [0.945"] #31.0 [1.220"]	XLRnet chassis, CAT5E with protective cap, IP65, Horizontal PCB, Rear mount	Panel 1.2mm to 2.5mm Panel 1.2mm to 2.5mm, Potted Panel 2.5mm to 3.8mm Panel 2.5mm to 3.8mm, Potted Panel 3.8mm to 5mm Panel 3.8mm to 5mm, Potted	RJXS8FP5H RJXS8FP5HP RJXS8FP15H RJXS8FP15HP RJXS8FP25H RJXS8FP25HP
		26.0 [1.024"] 19.0 [0.748"] 10.1 [0.398"] 6.9 [0.272"] 24.0 [0.945"] #24.0 [0.945"] #31.0 [1.220"]	XLRnet chassis, CAT6 with protective cap, IP65, Horizontal PCB, Rear mount	Panel 1.2mm to 2.5mm Panel 1.2mm to 2.5mm, Potted Panel 2.5mm to 3.8mm Panel 2.5mm to 3.8mm, Potted Panel 3.8mm to 5mm Panel 3.8mm to 5mm, Potted	RJXS8FP6H RJXS8FP6HP RJXS8FP16H RJXS8FP16HP RJXS8FP26H RJXS8FP26HP
		26.00 [1.024] 19.00 [0.748] 10.10 [0.398] 6.90 [0.272] 24.00 [0.945] 31.00 [1.220] 20.80 [0.819] 3.60 [0.142]	XLRnet chassis, CAT5E with protective cap, IP65, Shielded Hood, Horizontal PCB, Rear mount	Panel 1.2mm to 2.5mm Panel 1.2mm to 2.5mm, Potted Panel 2.5mm to 3.8mm Panel 2.5mm to 3.8mm, Potted Panel 3.8mm to 5mm Panel 3.8mm to 5mm, Potted	RJXS8FP5HE RJXS8FP5HPE RJXS8FP15HE RJXS8FP15HPE RJXS8FP25HE RJXS8FP25HPE
		26.00 [1.024] 19.00 [0.748] 10.10 [0.398] 6.90 [0.272] 24.00 [0.945] 31.00 [1.220] 20.80 [0.819] 3.60 [0.142]	XLRnet chassis, CAT6 with protective cap, IP65, Shielded Hood, Horizontal PCB, Rear mount	Panel 1.2mm to 2.5mm Panel 1.2mm to 2.5mm, Potted Panel 2.5mm to 3.8mm Panel 2.5mm to 3.8mm, Potted Panel 3.8mm to 5mm Panel 3.8mm to 5mm, Potted	RJXS8FP6HE RJXS8FP6HPE RJXS8FP16HE RJXS8FP16HPE RJXS8FP26HE RJXS8FP26HPE



XLR Connectors

XLRnet IP65 Range

PRODUCT - FIGURE	DRAWING	Dimensions in mm (inches)	DESCRIPTION	VARIATIONS	PART NUMBER
		26.0 [1.024"] 19.0 [0.748"] 10.1 [0.398"] 6.9 [0.272"] 24.0 [0.945"] 24.0 [0.945"] 31.0 [1.220"] 24.0 [0.945"] 6.9 [0.272"] 24.0 [0.945"] 6.9 [0.272"]	XLRnet chassis, CAT5E with protective cap, IP65, Vertical PCB, Rear mount	Panel 1.2mm to 2.5mm	RJSX8FP5V
				Panel 1.2mm to 2.5mm, Potted	RJSX8FP5VP
				Panel 2.5mm to 3.8mm	RJSX8FP15V
				Panel 2.5mm to 3.8mm, Potted	RJSX8FP15VP
				Panel 3.8mm to 5mm	RJSX8FP25V
				Panel 3.8mm to 5mm, Potted	RJSX8FP25VP
		26.0 [1.024"] 19.0 [0.748"] 10.1 [0.398"] 6.9 [0.272"] 24.0 [0.945"] 24.0 [0.945"] 31.0 [1.220"] 24.0 [0.945"] 6.9 [0.272"] 24.0 [0.945"] 6.9 [0.272"]	XLRnet chassis, CAT6 with protective cap, IP65, Vertical PCB, Rear mount	Panel 1.2mm to 2.5mm	RJSX8FP6V
				Panel 1.2mm to 2.5mm, Potted	RJSX8FP6VP
				Panel 2.5mm to 3.8mm	RJSX8FP16V
				Panel 2.5mm to 3.8mm, Potted	RJSX8FP16VP
				Panel 3.8mm to 5mm	RJSX8FP26V
				Panel 3.8mm to 5mm, Potted	RJSX8FP26VP
		26.0 [1.024"] 19.0 [0.748"] 10.1 [0.398"] 6.9 [0.272"] 24.0 [0.945"] 24.0 [0.945"] 31.0 [1.220"] 24.0 [0.945"] 6.9 [0.272"] 24.0 [0.945"] 6.9 [0.272"]	XLRnet chassis, CAT5E with protective cap, IP65, Shielded Hood, Vertical PCB, Rear mount	Panel 1.2mm to 2.5mm	RJSX8FP5VE
				Panel 1.2mm to 2.5mm, Potted	RJSX8FP5VEPE
				Panel 2.5mm to 3.8mm	RJSX8FP15VE
				Panel 2.5mm to 3.8mm, Potted	RJSX8FP15VEPE
				Panel 3.8mm to 5mm	RJSX8FP25VE
				Panel 3.8mm to 5mm, Potted	RJSX8FP25VEPE
		26.0 [1.024"] 19.0 [0.748"] 10.1 [0.398"] 6.9 [0.272"] 24.0 [0.945"] 24.0 [0.945"] 31.0 [1.220"] 24.0 [0.945"] 6.9 [0.272"] 24.0 [0.945"] 6.9 [0.272"]	XLRnet chassis, CAT6 with protective cap, IP65, Shielded Hood, Vertical PCB, Rear mount	Panel 1.2mm to 2.5mm	RJSX8FP6VE
				Panel 1.2mm to 2.5mm, Potted	RJSX8FP6VEPE
				Panel 2.5mm to 3.8mm	RJSX8FP16VE
				Panel 2.5mm to 3.8mm, Potted	RJSX8FP16VEPE
				Panel 3.8mm to 5mm	RJSX8FP26VE
				Panel 3.8mm to 5mm, Potted	RJSX8FP26VEPE

XLR Connectors

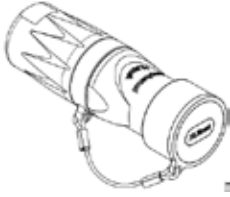
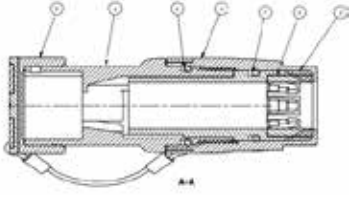
XLRnet IP65 Range

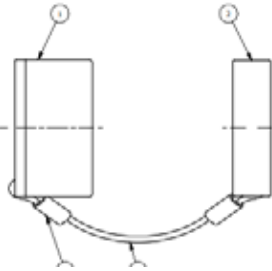
PRODUCT - FIGURE	DRAWING	DESCRIPTION	VARIATIONS	PART NUMBER
		XLRnet cable plug housing to suit preassembled RJ45 ethernet cables	Nickel finish	RJXS8M
			Black finish	RJXS8MB
		XLRnet cable plug cap assembly to suit RJX series XLRnet cable plugs with coloured I.D. ring	Brown I.D. ring	RJXS-CAPC-1
			Red I.D. ring	RJXS-CAPC-2
			Orange I.D. ring	RJXS-CAPC-3
			Yellow I.D. ring	RJXS-CAPC-4
			Green I.D. ring	RJXS-CAPC-5
			Blue I.D. ring	RJXS-CAPC-6
			Violet I.D. ring	RJXS-CAPC-7
			Grey I.D. ring	RJXS-CAPC-8
			White I.D. ring	RJXS-CAPC-9

PART NUMBER BREAKDOWN

PANEL

E. G. **RJXS8FP26VP**
RJXS (Series Prefix), **8** RJ45 Style, **F** (Four hole receptacle housing IP65 - Black - Rear Mounting),
P2 (Thermoplastic 3.8mm to 5mm with cap (Rear Mounting)), **6** Cat6 Compliant,
V Vertical Mount (PCB Thru Hole), **P** Potted (IP65 unmated)

SERIES PREFIX	RJX = Standard RJXS = Sealed IP54 or IP65 RJXP = Sealed IP65 without cap
CONTACT LAYOUTS	8 = RJ45 Style
GENDER	F = Receptacle Housing
SHELL SERIES	P = Thermoplastic 1.2mm-2.5mm (Rear mounting IP65) P1 = Thermoplastic 2.5mm to 3.8 mm with cap (Rear mounting IP65) P2 = Thermoplastic 3.8mm to 5 mm with cap (Rear mounting)
TRANSMISSION CLASS	5 = Cat5e Compliant 6 = Cat6 Compliant
TERMINATION	H = Horizontal Mount (PCB Thru hole) V = Vertical Mount (PCB Thru hole)
SEALED IP65 (RJXX)	P = Potted (IP65 unmated)
LOCKING MECHANISM	Blank = Latching P = Push lever supplied seperately for customer installation.
PACKAGING	Blank = Individual Bags B = Bulk Packed

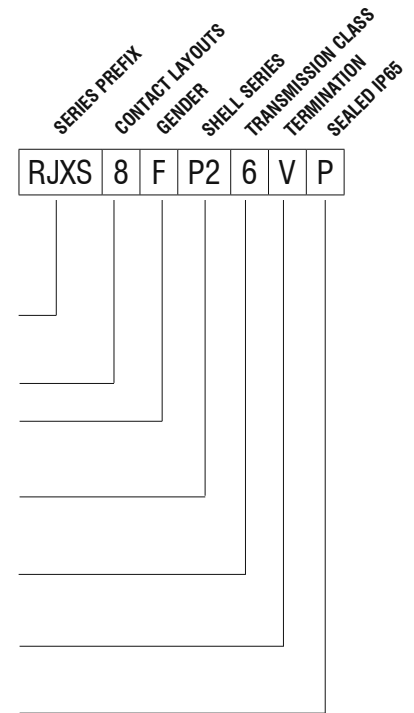

XLR Connectors

XLNet IP65 Range

PART NUMBER BREAKDOWN

PLUG CONNECTORS

E. G. **RJX8MB2**
RJX (Series Prefix), **8** RJ45 style, **M** Plug Housing,
Black Finish, **2** Red Ring Colour Option

SERIES PREFIX	RJX	=	Standard
	RJXS	=	Sealed IP65 with cap
	RJXP	=	Sealed IP65 without cap
CONTACT LAYOUTS	8	=	RJ45 style
GENDER	M	=	Plug Housing
SHELL SERIES	Blank	=	Nickel plated finish
	B	=	Black finish
RING COLOUR OPTION	Blank	=	Black
	1	=	Brown
	2	=	Red
	3	=	Orange
	4	=	Yellow
	5	=	Green
	6	=	Blue
	7	=	Violet
	8	=	Grey
9	=	White	
PACKAGING	Blank	=	Individual Bags
	BULK	=	Bulk Packed

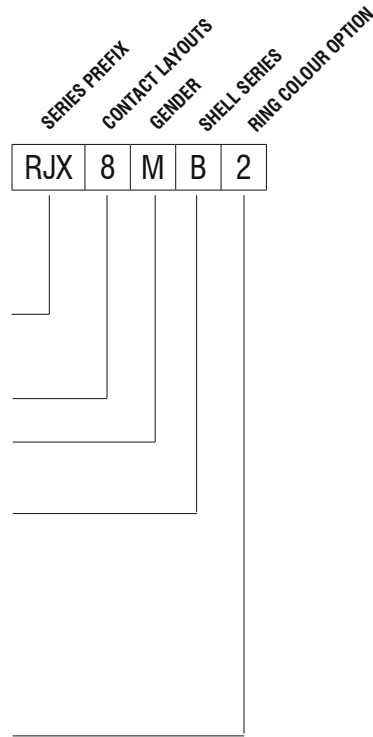

PART NUMBER BREAKDOWN

PROTECTIVE CAP

E. G. **RJX-CAPC**
RJX (Series Prefix), CAP Type, C Cable Plug male

SERIES PREFIX	RJX	=	Standard
	RJXS	=	Sealed IP54 or IP65
TYPE	CAP		
SHELL SERIES	F	=	Female panel
	M	=	Male Panel (Not available)
	C	=	Cable Plug male
	D	=	Cable Plug female
RING COLOUR OPTION	Blank	=	Black
	1	=	Brown
	2	=	Red
	3	=	Orange
	4	=	Yellow
	5	=	Green
	6	=	Blue
	7	=	Violet
	8	=	Grey
9	=	White	
OPTION	Blank	=	Lanyard
PACKAGING	Blank	=	Individual Bags
	BULK	=	Bulk Packed

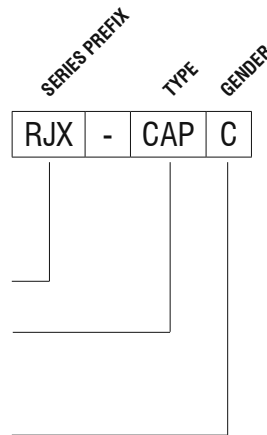

XLR Connectors

XLNet IP65 Range

STANDARD DATA XLRnet IP65 CHASSIS RECEPTACLES

		VALUE		
		Class D	CAT5E	CAT6
GENERAL CHARACTERISTICS	Number of contacts	8		
	Contact Arrangement	RJ45		
	Termination	Printed Circuit Board (PCB) - through hole, Feedthrough, IDC Terminal		
	Flammability	UL94V-0		
	Environmental	Complies with EU RoHS 2 Directive 2011/65/EU		
	Solderability	MIL-STD 202, Method 208		
ELECTRICAL CHARACTERISTICS	Rated current per contact	1.5 A		
	Rated Voltage	125V AC		
	Typical Contact Resistance	20mΩ		
	Insulation Resistance	> 500MΩ		
	Dielectric Strength	1000 VAC, 60 secs		
	Max. Frequency	100Mhz	100MHz	250MHz
	Ethernet Standard	10/100 BASE-T	1000 BASE-T	10GBASE-T
	Transmission Spec.	EIA/ TIA568-C.2, ISO/IEC 11801, EN50173		
	PoE	802.3at Type 2	Types 1 to 4 and IEC60603-7 compliant	
	LED Type	Round, single pole, indicator		
CLIMATIC CHARACTERISTICS	Protection Class - RJX - RJXS	IP40 (with EMI/RFI shield) IP54 (non potted) IP65 (potted)		
	Operating Temperature	-40°C to +80°C (-40°F to +176°F)		
MECHANICAL CHARACTERISTICS	Weight** - A & B Housing - Shielded Housing - D Shell	11g (0.024lb) 17g (0.037lb) 25g (0.055lb)		
	Mechanical Operations	1000		
	Insertion and Withdrawal Force	≤ 21N		
	Latch	Spring Steel		
	Panel Thickness max.	RJXS series panel thickness variable, three groups: S: 1.2-2.5, M: 2.5-3.5, L: 3.8-5.0		
	Mounting screw torque max.	0.35Nm		
	Fastener	Self-Tapping screw M2.5		
MATERIALS	Connector Shell / Housing	PA66-R10G251 (fff)(f1) KINGFA SCI&TECH, E171666		
	Front Panel Gasket	121-80 SANTOPRENE		
	Potting Compound	AW8829 RESIN GLUE		
	Contact	Phosphor Bronze		
	Contact Finish - Ground - RJ45	0.38μm Au over 1.27μm Ni 1.27μm Au over 1.27μm Ni		
	Metal Hood Shield EMI/RFI	BRASS UNS #26800 PRE-PLATED 0.25mm THK		
Latch lock and Spring	CARBON STEEL SAE 1055			
PANEL THICKNESS	Option "P"	1.5mm - 2.5mm (0.059" - 0.098")		
	Option "P1"	2.5mm - 3.5mm (0.098" - 0.137")		
	Option "P2"	3.8mm - 5mm (0.149" - 0.196")		

**Approximate weight in grams not including packaging. Please contact us for exact weight for shipping purposes.

Rev 2 - 04/2025



AC SERIES XLR PCB CHASSIS MOUNT CONNECTORS

The AC series, A and B type XLR chassis receptacles have been designed and manufactured with the Original Equipment Manufacturers' (OEM) needs in mind. The compact shell design allows a significant space saving over the traditional 'D' type shell. Gold plated contacts improve the performance, ensuring a reliable contact and the unique grounding link options offer flexibility in design.

Features

- A leading first mate last break socket contact is standard on all female connectors (Pin 1).
- Vertical and Horizontal PCB versions available.
- Latching and Non-latching versions available.
- A range of different grounding options are available including:
 - Mating connector shell to Pin 1
 - Mating connector shell to Chassis
 - Mating connector shell to pin 1 to Chassis
- A type is available in 3, 4 or 5 contacts.
- B type is available in 3 contact only.
- Compatible with all other XLR brands.
- Metal Mounting Flange (B type)

Options

- Vertical PCB contacts
- Horizontal PCB contacts
- Precision Machined Pin contacts
- Cost effective Stamped Socket contacts
- Gold Plated contacts (Standard)
- Silver Plated contacts (Optional)
- Bulk Packaging
- Integrated Switch

Ordering Codes

We have listed the more common ordering codes in each section. For further options please refer to the part number breakdown charts. Please contact us if you need any further assistance.

Simple steps to guide you in using this catalogue

- 1) Identify the product group listed in Contents on page 1 and go directly to that page number.
- 2) Each product group cover page then details information and options available.
- 3) Refer to the product detail pages and identify the product you require pictorially.
- 4) Read the product description column for the products standard features.
- 5) Use variations column to determine your choice.
- 6) Identify part number.
- 7) In the event the particular option you require is not listed please refer to the part number breakdown page at the end of each section.
- 8) Please contact us directly if you have any further problems.

XLR Connectors

AC Series XLR PCB Chassis Mount Connectors



A TYPE

Features:

- Thermoplastic Shell
- Contact layouts in 3,4 or 5
- Industry standard PCB footprints.
- Vertical or Horizontal PCB mounting.
- Precision machined pin contacts.
- Gold plated contacts.
- Leading first mate last break socket contact.
- Bulk packed in trays, 100 to a box as standard.
- Positive latch lock system.

Options: Vertical or Horizontal PCB, Various grounding methods, Latching or Non-Latching.

Part Number Breakdown: Page 51 Specifications: Page 54 PCB Footprints: Page 55 Panel Cutouts: Page 56 Recommended Fastener: Page 154

PRODUCT - FIGURE	DRAWING	Dimensions in mm (inches)	DESCRIPTION	GROUND LINK VARIATIONS	PART NUMBER
		25.4 [.998"] 19.5 [.768"] 19.8 [.780"] 2.7 [.106"] 12.5 [.492"] 19.8 [.780"]	XLR 3 pole male, Horizontal PCB, Gold Plated Contacts, Bulk Pack	No Ground Link	AC3MAH-AU-PRE
		25.4 [.998"] 19.5 [.768"] 19.8 [.780"] 2.7 [.106"] 12.5 [.492"] 19.8 [.780"]	XLR 3 pole male, Horizontal PCB, Gold Plated Contacts, Bulk Pack	Pin 1 to Chassis to Mating connector shell	AC3MAH1-AU-PRE
		25.4 [.998"] 19.5 [.768"] 19.8 [.780"] 2.7 [.106"] 12.5 [.492"] 19.8 [.780"]	XLR 3 pole male, Horizontal PCB, Gold Plated Contacts, Bulk Pack	Mating connector shell to Chassis - Pin 1 sep. Ground	AC3MAH2-AU-PRE
		25.4 [.998"] 19.5 [.768"] 19.8 [.780"] 2.7 [.106"] 12.5 [.492"] 19.8 [.780"]	XLR 3 pole male with integrated switch, Horizontal PCB, Gold Plated Contacts, Bulk Pack	Mating connector shell to Chassis to PCB, Pin 1 sep. Ground	AC3MAH4-SW-B
		25.4 [.998"] 24.0 [.945"] 19.5 [.768"] 19.8 [.780"] 2.7 [.106"] 3.5 [.138"] 19.8 [.780"]	XLR 3 pole male, Vertical PCB, Gold Plated Contacts, Bulk Pack	No Ground Link	AC3MAV-AU-PRE











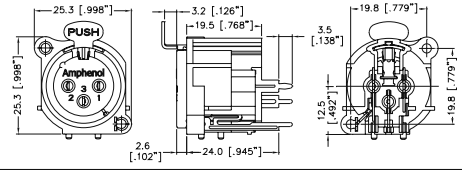

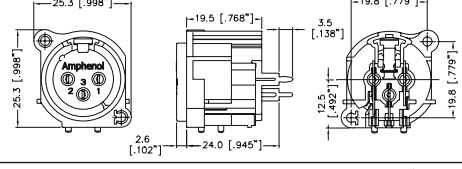

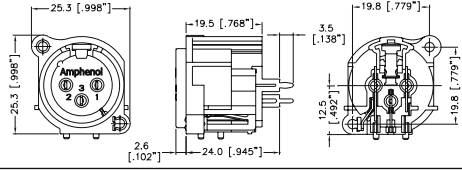

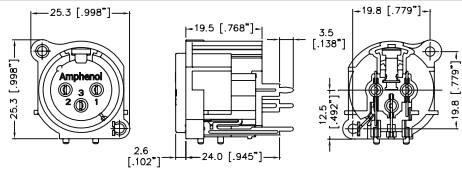
XLR Connectors

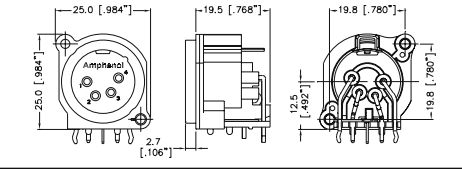
AC Series XLR PCB Chassis Mount Connectors

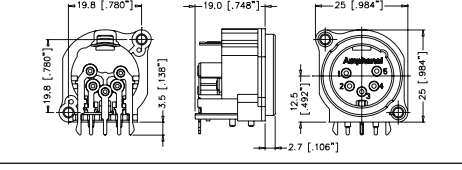
PRODUCT - FIGURE	DRAWING	Dimensions in mm (inches)	DESCRIPTION	GROUND LINK VARIATIONS	PART NUMBER
		25.4 [998"] 25.4 [998"] 24.0 [945"] 19.5 [768"] 19.8 [780"] 2.7 [106"] 3.5 [138"] 19.8 [780"] 19.8 [780"]	XLR 3 pole male, Vertical PCB, Gold Plated Contacts, Bulk Pack	Mating connector shell to Chassis - Pin 1 sep. Ground	AC3MAV2-AU-PRE
		25.4 [998"] 25.4 [998"] 24.0 [945"] 19.5 [768"] 19.8 [780"] 2.7 [106"] 19.8 [780"] 19.8 [780"]	XLR 3 pole male, Solder Buckets, Gold Plated Contacts, Bulk Pack	No Ground Link	AC3MA-AU-B
		25.4 [998"] 25.4 [998"] 3.2 [126"] 19.5 [768"] 19.8 [780"] 2.6 [102"] 12.5 [492"] 19.8 [780"] 19.8 [780"]	XLR 3 pole female, Horizontal PCB, Latching Type, Gold Plated Contacts, Bulk Pack	No Ground Link	AC3FAH-AU-PRE
		25.4 [998"] 25.4 [998"] 3.2 [126"] 19.5 [768"] 19.8 [780"] 2.6 [102"] 12.5 [492"] 19.8 [780"] 19.8 [780"]	XLR 3 pole female, Horizontal PCB, Latching Type, Gold Plated Contacts, Bulk Pack	Pin 1 to Chassis to Mating connector shell	AC3FAH1-AU-PRE
		25.4 [998"] 25.4 [998"] 3.2 [126"] 19.5 [768"] 19.8 [780"] 2.6 [102"] 12.5 [492"] 19.8 [780"] 19.8 [780"]	XLR 3 pole female, Horizontal PCB, Latching Type, Gold Plated Contacts, Bulk Pack	Mating connector shell to Chassis - Pin 1 sep. Ground	AC3FAH2-AU-PRE
		25.4 [998"] 25.4 [998"] 19.5 [768"] 19.8 [780"] 2.6 [102"] 12.5 [492"] 19.8 [780"] 19.8 [780"]	XLR 3 pole female, Horizontal PCB, Non-Latching Type Gold Plated Contacts, Bulk Pack	No Ground Link	AC3FAHL-AU-PRE
		25.4 [998"] 25.4 [998"] 19.5 [768"] 19.8 [780"] 2.6 [102"] 12.5 [492"] 19.8 [780"] 19.8 [780"]	XLR 3 pole female, Horizontal PCB, Non-Latching Type Gold Plated Contacts, Bulk Pack	Pin 1 to Chassis to mating connector shell	AC3FAHL1-AU-PRE
		25.4 [998"] 25.4 [998"] 19.5 [768"] 19.8 [780"] 2.6 [102"] 12.5 [492"] 19.8 [780"] 19.8 [780"]	XLR 3 pole female, Horizontal PCB, Non-Latching Type Gold Plated Contacts, Bulk Pack	Mating connector shell to Chassis - Pin 1 sep. Ground.	AC3FAHL2-AU-PRE
		25.3 [998"] 25.3 [998"] 3.2 [126"] 19.5 [768"] 19.8 [779"] 2.6 [102"] 24.0 [945"] 12.5 [492"] 3.5 [138"] 19.8 [779"] 19.8 [779"]	XLR 3 pole female, Vertical PCB, Latching Type, Gold Plated Contacts, Bulk Pack	No Ground Link	AC3FAV-AU-PRE
		25.3 [998"] 25.3 [998"] 3.2 [126"] 19.5 [768"] 19.8 [779"] 2.6 [102"] 24.0 [945"] 12.5 [492"] 3.5 [138"] 19.8 [779"] 19.8 [779"]	XLR 3 pole female, Vertical PCB, Latching Type, Gold Plated Contacts, Bulk Pack	Pin 1 to Chassis to Mating connector shell	AC3FAV1-AU-PRE

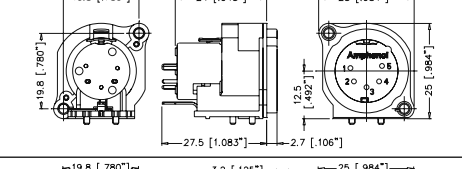
XLR Connectors

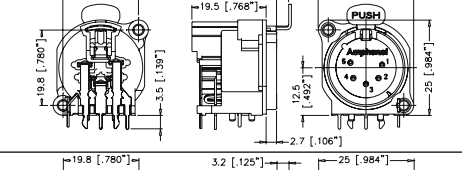
AC Series XLR PCB Chassis Mount Connectors

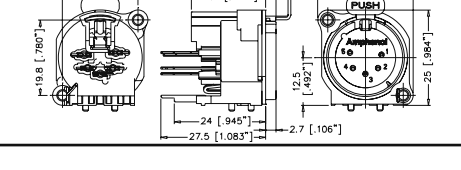
PRODUCT - FIGURE	DRAWING	Dimensions in mm (inches)	DESCRIPTION	GROUND LINK VARIATIONS	PART NUMBER
			XLR 3 pole female, Vertical PCB, Latching Type, Gold Plated Contacts, Bulk Pack	Mating connector shell to Chassis - Pin 1 sep. Ground.	AC3FAV2-AU-PRE
			XLR 3 pole female, Vertical PCB, Non-Latching Type, Gold Plated Contacts, Bulk Pack	No Ground Link	AC3FAVL-AU-PRE
			XLR 3 pole female, Vertical PCB, Non-Latching Type, Gold Plated Contacts, Bulk Pack	Pin 1 to Chassis to Mating connector shell	AC3FAVL1-AU-PRE
			XLR 3 pole female, Vertical PCB, Non-Latching Type, Gold Plated Contacts, Bulk Pack	Mating connector shell to Chassis - Pin 1 sep. Ground.	AC3FAVL2-AU-PRE
			XLR 4 pole male, Horizontal PCB, Gold Plated Contacts, Bulk Pack	Mating connector shell to Chassis - Pin 1 sep. Ground	AC4MAH-AU-B
			XLR 5 pole male, Horizontal PCB, Gold Plated Contacts, Bulk Pack	Mating connector shell to Chassis to PCB, Pin 1 sep. Ground	AC5MAH-AU-B
			XLR 5 pole male, Vertical PCB, Gold Plated Contacts, Bulk Pack	Mating connector shell to Chassis to PCB, Pin 1 sep. Ground	AC5MAV-AU-B
			XLR 5 pole female, Horizontal PCB, Gold Plated Contacts, Bulk Pack	Mating connector shell to Chassis to PCB, Pin 1 sep. Ground	AC5FAH-AU-B
			XLR 5 pole female, Vertical PCB, Gold Plated Contacts, Bulk Pack	Mating connector shell to Chassis to PCB, Pin 1 sep. Ground	AC5FAV-AU-B



B TYPE

Features:

- Thermoplastic Shell with Metal Mounting Flange
- Contact layouts in 3 or 5
- Industry standard PCB footprints
- Improved grounding performance
- Vertical or Horizontal PCB mounting
- Precision machined pin contacts
- Gold plated contacts
- Leading first mate last break socket contact
- Bulk packed in trays, 100 to a box as standard
- Positive latch lock system

Options: Silver plated contacts, Vertical or Horizontal PCB, Various grounding methods, Latching or Non-Latching.

Part Number Breakdown: [Page 51](#) **Specifications:** [Page 54](#)
PCB Footprints: [Page 55](#) **Panel Cutouts:** [Page 56](#)
Recommended Fastener: [Page 154](#)

PRODUCT - FIGURE	DRAWING	Dimensions in mm (inches)	DESCRIPTION/ GROUND LINK	MOUNTING FLANGE VARIATIONS	PART NUMBER
			XLR 3 pole male, Horizontal PCB, Gold Plated Contacts, Bulk Pack No Ground Link	Nickel Finish	AC3MBH-AU-PRE
			XLR 3 pole male, Horizontal PCB, Gold Plated Contacts, Bulk Pack Pin 1 to Chassis to Mating connector shell	Nickel Finish	AC3MBH1-AU-PRE
			XLR 3 pole male, Horizontal PCB, Gold Plated Contacts, Bulk Pack Mating connector shell to Chassis - Pin 1 sep. Ground	Nickel Finish	AC3MBH2-AU-PRE
			XLR 3 pole male, Horizontal PCB, Gold Plated Contacts, Bulk Pack Mating connector shell to Pin 1	Nickel Finish	AC3MBH3-AU-PRE
			XLR 3 pole male, Horizontal PCB, Non-Latching Type, Gold Plated Contacts, Bulk Pack No Ground Link	Nickel Finish	AC3MBHL-AU-PRE
			XLR 3 pole male, Vertical PCB, Gold Plated Contacts, Bulk Pack No Ground Link	Nickel Finish	AC3MBV-AU-PRE









XLR Connectors

AC Series XLR PCB Chassis Mount Connectors

PRODUCT - FIGURE	DRAWING	Dimensions in mm (inches)	DESCRIPTION/ GROUND LINK	MOUNTING FLANGE VARIATIONS	PART NUMBER
			XLR 3 pole male, Vertical PCB, Gold Plated Contacts, Bulk Pack Pin 1 to Chassis to Mating connector shell	Nickel Finish	AC3MBV1-AU-PRE
			XLR 3 pole male, Vertical PCB, Gold Plated Contacts, Bulk Pack Mating connector shell to Chassis - Pin 1 sep. Ground	Nickel Finish	AC3MBV2-AU-PRE
			XLR 3 pole male, Vertical PCB, Gold Plated Contacts, Bulk Pack Mating connector shell to Pin 1	Nickel Finish	AC3MBV3-AU-PRE
			XLR 3 pole female, Horizontal PCB, Latching Type, Gold Plated Contacts, Bulk Pack No Ground Link	Nickel Finish	AC3FBH-AU-PRE
			XLR 3 pole female, Horizontal PCB, Latching Type, Gold Plated Contacts, Bulk Pack Pin 1 to Chassis to Mating connector shell	Nickel Finish	AC3FBH1-AU-PRE
			XLR 3 pole female, Horizontal PCB, Latching Type, Gold Plated Contacts, Bulk Pack Mating connector shell to Chassis - Pin 1 sep. Ground	Nickel Finish	AC3FBH2-AU-PRE
			XLR 3 pole female, Horizontal PCB, Latching Type, Gold Plated Contacts, Bulk Pack Pin 1 to Chassis	Nickel Finish	AC3FBH3-AU-PRE
			XLR 3 pole female, Horizontal PCB, Non-Latching Type Gold Plated Contacts, Bulk Pack No Ground Link	Nickel Finish	AC3FBHL-AU-PRE











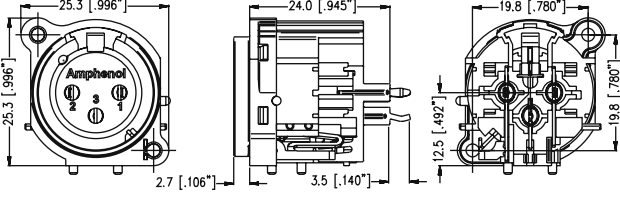

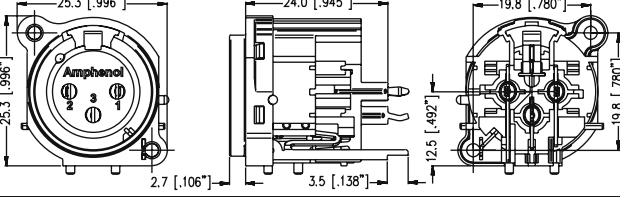
XLR Connectors

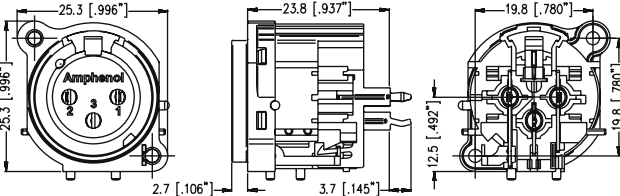
AC Series XLR PCB Chassis Mount Connectors

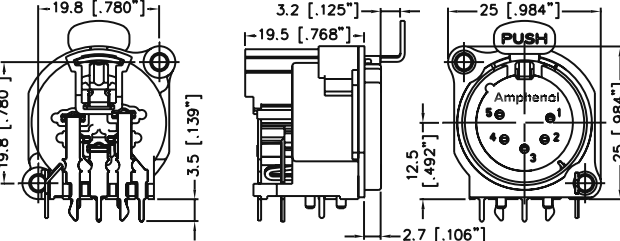
PRODUCT	DRAWING Dimensions in mm (inches)	DESCRIPTION/ GROUND LINK	FINISH	PART NUMBER
		XLR 3 pole female, Horizontal PCB, Non-Latching Type Gold Plated Contacts, Bulk Pack Pin 1 to Chassis to mating connector shell	Nickel Finish	AC3FBHL1-AU-PRE
		XLR 3 pole female, Horizontal PCB, Non- Latching Type, Gold Plated Contacts, Bulk Pack Mating connector shell to Chassis - Pin 1 sep. Ground.	Nickel Finish	AC3FBHL2-AU-PRE
		XLR 3 pole female, Horizontal PCB, Non-Latching Type Gold Plated Contacts, Bulk Pack Pin 1 to Chassis	Nickel Finish	AC3FBHL3-AU-PRE
		XLR 3 pole female, Vertical PCB, Latching Type, Gold Plated Contacts, Bulk Pack No Ground Link	Nickel Finish	AC3FBV-AU-PRE
		XLR 3 pole female, Vertical PCB, Latching Type, Gold Plated Contacts, Bulk Pack Pin 1 to Chassis to mating connector shell	Nickel Finish	AC3FBV1-AU-PRE
		XLR 3 pole female, Vertical PCB, Latching Type, Gold Plated Contacts, Bulk Pack Mating connector shell to Chassis - Pin 1 sep. Ground.	Nickel Finish	AC3FBV2-AU-PRE
		XLR 3 pole female, Vertical PCB, Latching Type, Gold Plated Contacts, Bulk Pack Pin 1 to Chassis	Nickel Finish	AC3FBV3-AU-PRE
		XLR 3 pole female, Vertical PCB, Non-Latching Type, Gold Plated Contacts, Bulk Pack No Ground Link	Nickel Finish	AC3FBVL-AU-PRE

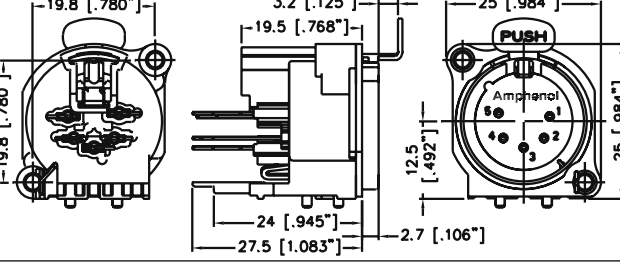
XLR Connectors

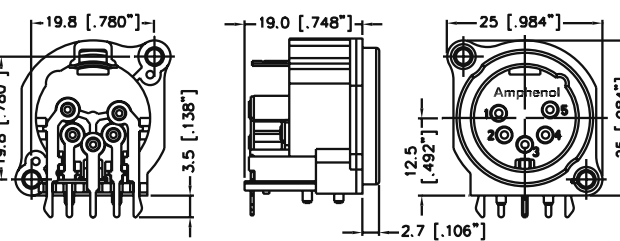
AC Series XLR PCB Chassis Mount Connectors

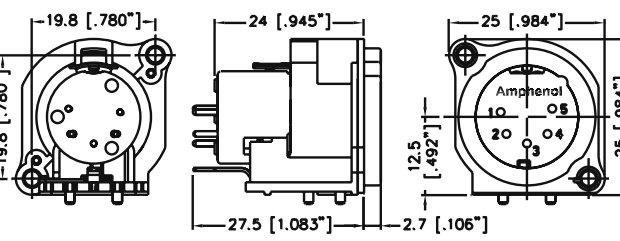
PRODUCT	DRAWING Dimensions in mm (inches)	DESCRIPTION/ GROUND LINK	FINISH	PART NUMBER
		XLR 3 pole female, Vertical PCB, Non-Latching Type, Gold Plated Contacts, Bulk Pack Pin 1 to Chassis to Mating connector shell	Nickel Finish	AC3FBVL1-AU-PRE
		XLR 3 pole female, Vertical PCB, Non-Latching Type, Gold Plated Contacts, Bulk Pack Mating connector shell to Chassis-Pin 1 sep. Ground.	Nickel Finish	AC3FBVL2-AU-PRE
		XLR 3 pole female, Vertical PCB, Non-Latching Type, Gold Plated Contacts, Bulk Pack Pin 1 to Chassis	Nickel Finish	AC3FBVL3-AU-PRE
		XLR 5 pole female, Horizontal PCB, Latching Type, Gold Plated Contacts, Bulk Pack	Nickel Finish	AC5FBH-AU-PRE
		XLR 5 pole female, Vertical PCB, Latching Type, Gold Plated Contacts, Bulk Pack	Nickel Finish	AC5FBV-AU-PRE
		XLR 5 pole male, Horizontal PCB, Gold Plated Contacts, Bulk Pack	Nickel Finish	AC5MBH-AU-PRE
		XLR 5 pole male, Vertical PCB, Gold Plated Contacts, Bulk Pack	Nickel Finish	AC5MBV-AU-PRE

PART NUMBER BREAKDOWN

AC SERIES A AND B TYPE MALE - 3 CONTACT

E. G. **AC3MAVL3-AU PRE**

AC (series prefix), **3** contacts, **M**ale, **A** Type, **V**ertical Printed Circuit Board, **L**atchless, **3** (Mating Shell to Pin 1 Grounding), - **AU** (Gold Plated Contacts), **PRE** Bulk Packaged.

SERIES PREFIX	AC = Series Prefix
CONTACT LAYOUT	3 = 3 Contact only
GENDER	M = Male Socket Contacts
SHELL SERIES	A = A Type B = B Type
TERMINATION	H = Horizontal Printed Circuit Board V = Vertical Printed Circuit Board Blank = Solder Bucket Contacts
MOUNTING FLANGE FINISH (B TYPE ONLY)	Blank = Nickel
LOCKING MECHANISM	Blank = Latching L = Latchless
GROUNDING LINK OPTIONS	Blank = No Ground Link 1 = Pin 1 to Chassis to mating connector shell 2 = Mating Connector shell to Chassis, Pin 1 to separate ground 3 = Mating connector to Pin 1 4 = Mating connector to Shell to Chassis to PCB, Pin 1 separate ground
CONTACT PLATING	AU = Gold Plated Contacts AG = Silver Plated Contacts (Non-Standard)
PACKAGING	PRE = Bulk Packed PRD = Disassembled push latch

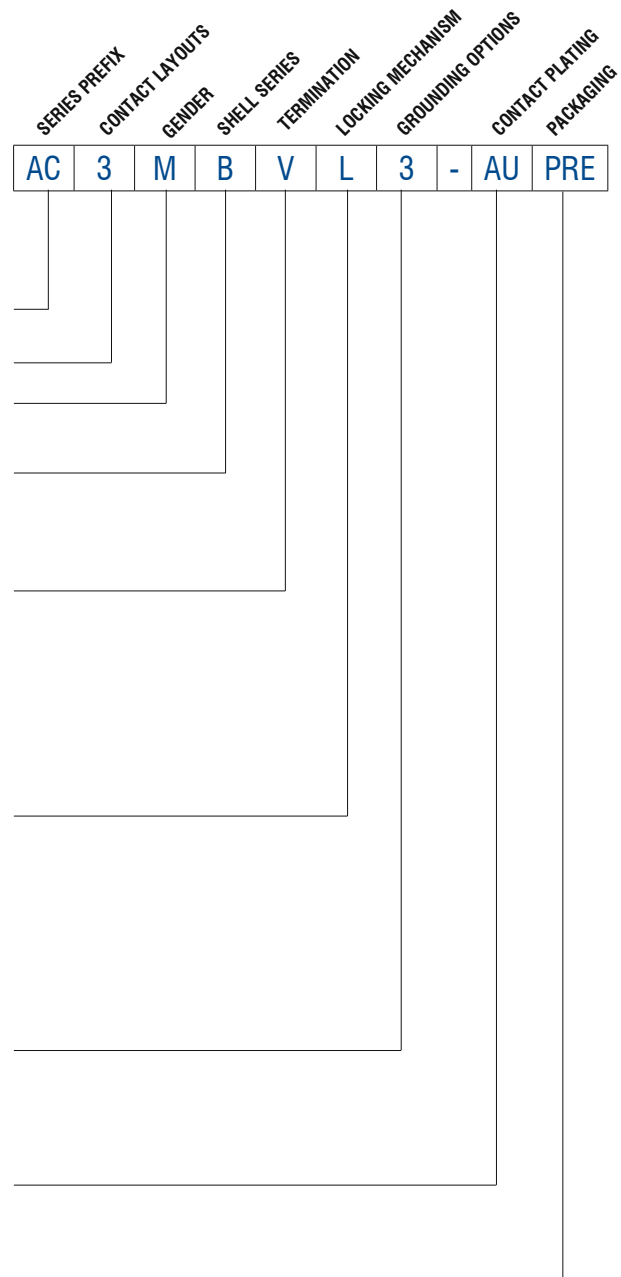

XLR Connectors

AC Series XLR PCB Chassis Mount Connectors

PART NUMBER BREAKDOWN

AC SERIES A AND B TYPE FEMALE - 3 CONTACT

E. G. **AC3MAVL3-AU B**
AC (series prefix), **3** contacts, **F**emale, **A** Type, **V**ertical Printed Circuit Board, **L**atchless, **3** (Pin 1 to Chassis Grounding), **- AU** (Gold Plated Contacts), **PRE** Bulk Packaged.

SERIES PREFIX	AC = Series Prefix
CONTACT LAYOUT	3 = 3 Contact only
GENDER	F = Female Socket Contacts
SHELL SERIES	A = A Type B = B Type
TERMINATION	H = Horizontal Printed Circuit Board V = Vertical Printed Circuit Board
LOCKING MECHANISM	Blank = Latching L = Latchless
GROUNDING LINK OPTIONS	Blank = No Ground Link 1 = Pin 1 to Chassis to mating connector shell 2 = Mating Connector shell to Chassis, Pin 1 to separate ground 3 = Pin 1 to Chassis
CONTACT PLATING	AU = Gold Plated Contacts AG = Silver Plated Contacts (Non-Standard)
PACKAGING	PRE = Bulk Packed PRD = Disassembled push latch

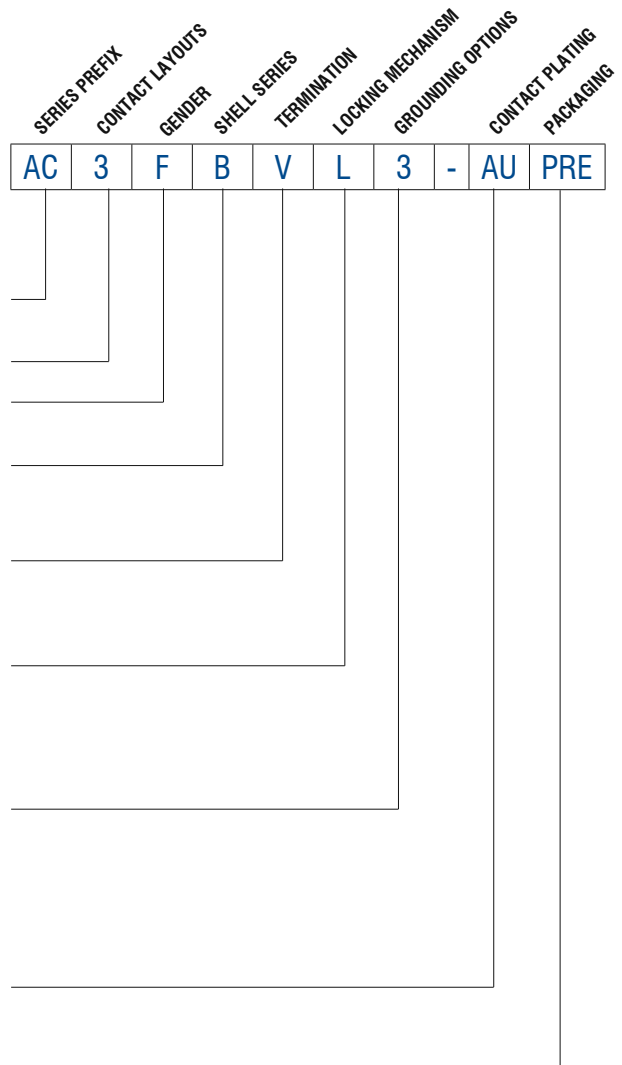

PART NUMBER BREAKDOWN

AC SERIES A AND B TYPE MALE AND FEMALE - 4 / 5 CONTACT

E. G. **AC5FAV-AU-B**
AC (series prefix), **5** contacts, **F**emale, **A** Type, **V**ertical Printed Circuit Board, **AU**
 (Gold Plated Contacts) - **B**ulk Packaged.

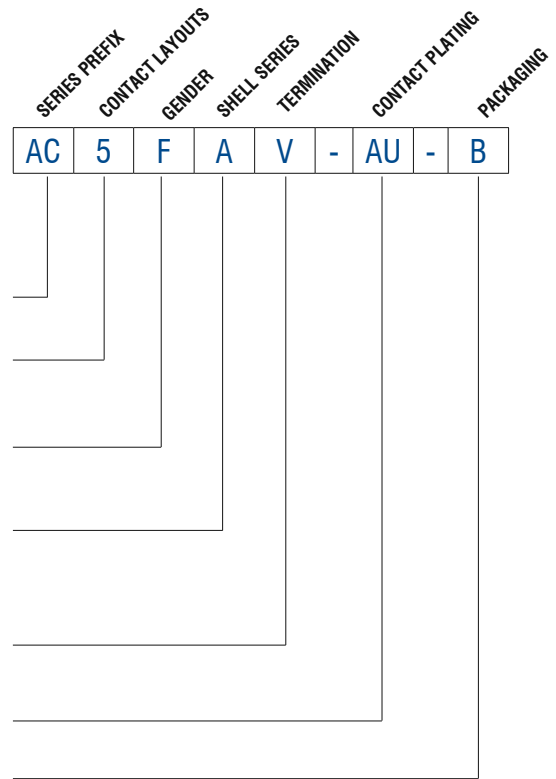

SERIES PREFIX	AC = Series Prefix
CONTACT LAYOUT	4 = 4 Contact 5 = 5 Contact
GENDER	F = Female Socket Contacts M = Male Pin Contacts
SHELL SERIES	A = A Type B = B Type
TERMINATION	H = Horizontal Printed Circuit Board V = Vertical Printed Circuit Board
CONTACT PLATING	AU = Gold Plated Contacts
PACKAGING	B = Bulk Packed PRE = PRE Series Bulk Packed



XLR Connectors

AC Series XLR PCB Chassis Mount Connectors

STANDARD DATA AC SERIES A AND B TYPE CHASSIS

		VALUE		
GENERAL CHARACTERISTICS	Number of contacts	3	4	5
	Contact Arrangements (Front view of pin insert)			
	Termination	Printed Circuit Board (PCB)		
	Flammability rating of plastics	UL94V-0		
	Environmental	Complies with EU RoHS 2 Directive 2011/65/EU		
ELECTRICAL CHARACTERISTICS	Service Voltage RMS	133V ¹		
	Test Voltage AC RMS	1500V		
	Current carrying capacity	6A		3A
	Typical Contact Resistance	≤5mΩ		
	Insulation Resistance (initial)	≥2GΩ		
	Insulation Resistance (after damp heat test)	≥1GΩ		
CLIMATIC CHARACTERISTICS	Protection Class	IP40		
	Operating Temperature	-25 °C to +75 °C (-13°F to +167°F)		
MECHANICAL CHARACTERISTICS	Weight ²	14g (0.030lb)		
	Retention Spring separating force	≥20N		
	Mounting Screw torque max.	1.5Nm		
	Mechanical Operations	Minimum 1000 mating cycles		
	Fastening A Type Connectors ³	Self-Tapping PT screw with thread 2.9 x 1.06 and of Tri-rondular configuration		
	Fastening B Type Connectors ³	Self-Tapping screw M2.5		
MATERIALS	Connector Flange - B-Type	Diecast Zinc Alloy		
	Flange Finish - B-Type	Nickel		
	Insulators	PA6.6+25% glass fibre reinforced, UL94V-0		
	Male Contact Material	Brass		
	Male Contact Plating	gold over nickel		
	Female Contact Material	Bronze		
	Female Contact Plating	gold over nickel		
	Latch lock and Spring	Spring Steel		
	Ground element	Spring Steel		

¹ Not suitable for domestic applications above 50V

² Approximate weight only, does not include packaging. Please contact us for exact weight for shipping purposes.

³ Refer to page 154

Rev 13- 03/2026

AC SERIES A AND B TYPE CHASSIS PCB FOOTPRINTS - CONNECTOR SIDE OF PCB

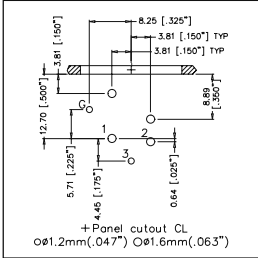

**AC3FAH2
AC3FBH2**

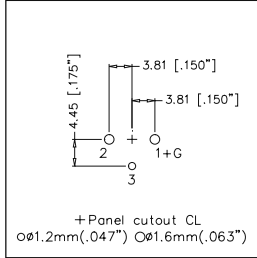

**AC3FAV1
AC3FAV3
AC3FBV1
AC3FBV3
AC3FAV
AC3FBV**

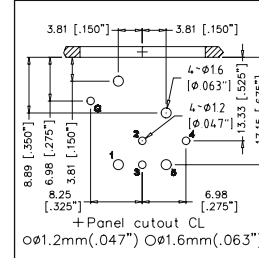

AC5FAH

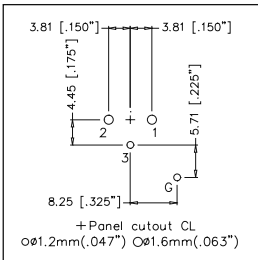

**AC3FAV2
AC3FBV2**

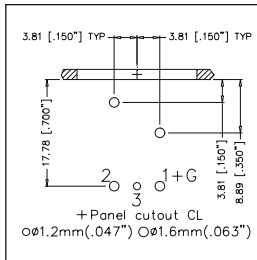

**AC3MAH1
AC3MAH3
AC3MBH1
AC3MBH3
AC3MAH
AC3MBH
AC3MBHL**

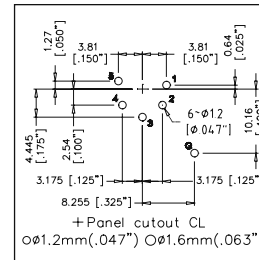

AC5FAV

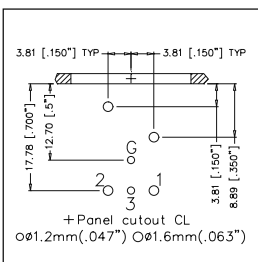

**AC3MAH2
AC3MAH4
AC3MBH2**

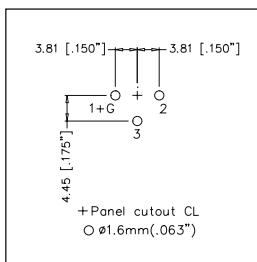

**AC3MAV1
AC3MAV3
AC3MBV1
AC3MBV3
AC3MAV
AC3MBV**

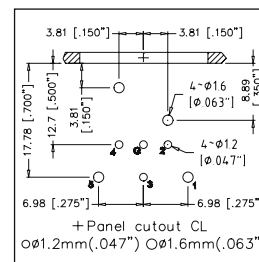

AC5MAH

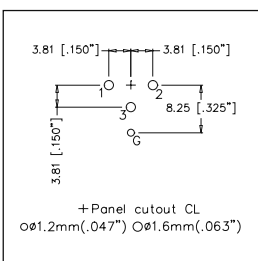

**AC3MAV2
AC3MAV4
AC3MBV2**

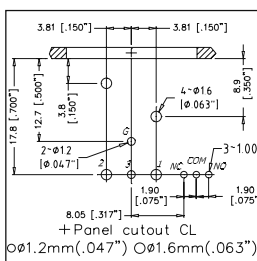

AC3MAH4SWB

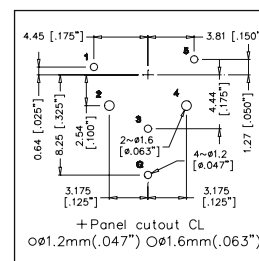

AC5MAV

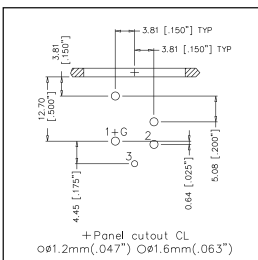

**AC3FAH1
AC3FAH3
AC3FBH1
AC3FBH3
AC3FAH
AC3FBH**

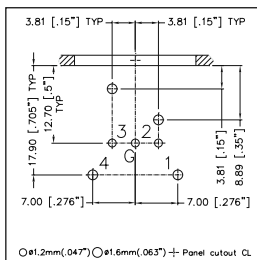

AC4MAH

XLR Connectors

AC Series XLR PCB Chassis Mount Connectors

AC SERIES A AND B TYPE CHASSIS PANEL CUTOUT DIMENSIONS - FRONT VIEW

A TYPE

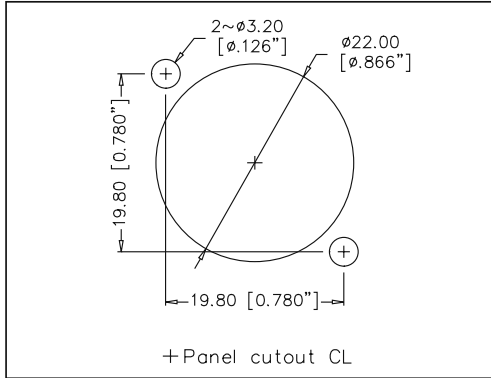

B TYPE

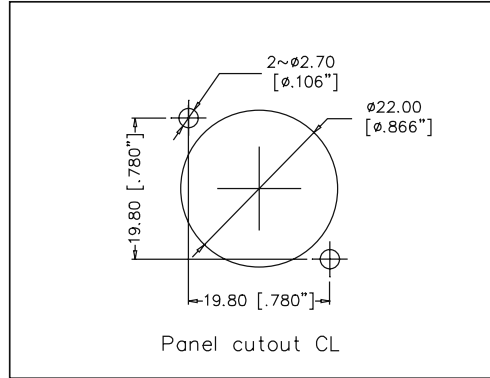

**A AND B
TYPE MALE
MOUNTING
PITCH**

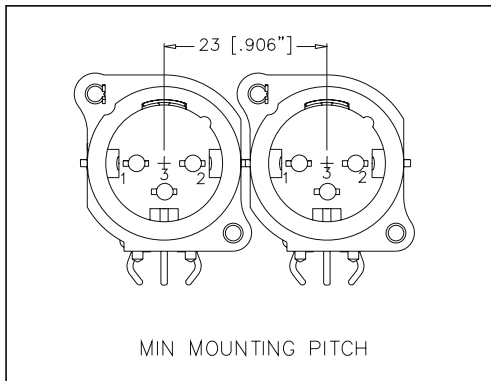

**A AND
B TYPE
FEMALE
MOUNTING
PITCH**

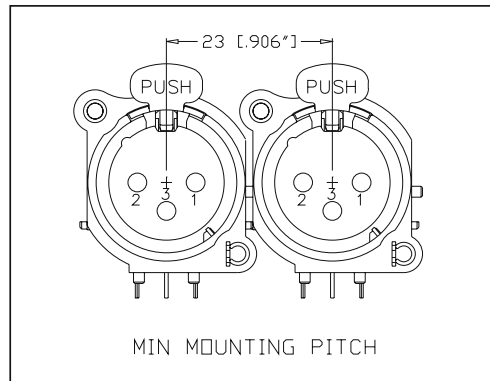

AC3FA/BH/V SCHEMATIC CHART

AC3FA/BH/V3-AU
 AC3FA/BH/VL3-AU

AC3FA/BH/V2-AU
 AC3FA/BH/VL2-AU

AC3FA/BH/V1-AU
 AC3FA/BH/VL1-AU

AC3FA/BH/V-AU
 AC3FA/BH/VL-AU

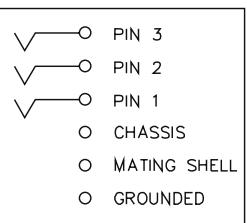
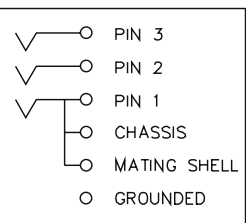
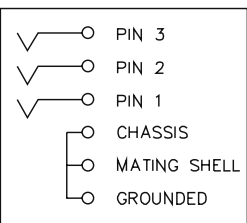
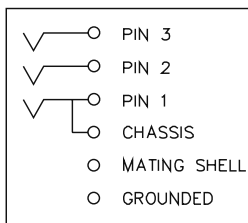

AC3MA/BH/V3-AU
 AC3MA/BH/VL3-AU

AC3MA/BH/V2/4-AU
 AC3MA/BH/VL2/4-AU

AC3MA/BH/V1-AU
 AC3MA/BH/VL1-AU

AC3MA/BH/V-AU
 AC3MA/BH/VL-AU

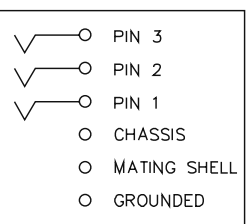
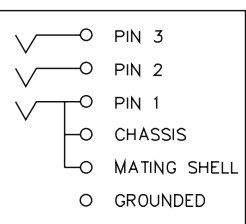
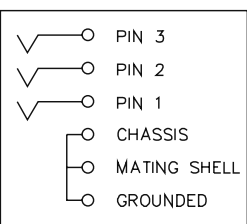
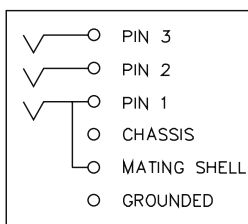



AC SERIES DUAL 1/4" (6.35MM) / XLR CHASSIS MOUNT

The AC Series C type chassis receptacles feature two connectors in the one space saving housing. A combined XLR female receptacle together with a 6.35mm (1/4") phone jack give the designer more flexibility ensuring premium board space is saved. The new low profile high density C type offers a 15% space saving over the traditional C type. Various configurations are available in either stereo or mono layouts with Vertical, Horizontal Printed Circuit Board or Solder contacts.

Features

- Standard or low profile / high density shell design
- Two connectors in the one housing.
- Industry standard PCB footprint layout on standard C type.
- Vertical or Horizontal PCB mounting.
- Bulk packed.
- Positive latch lock system (XLR).

Options

- Solder contacts
- Vertical PCB contacts
- Horizontal PCB contacts
- Bulk Packaging
- Overmoldable connector housing

Ordering Codes

We have listed the more common ordering codes in each section. For further options please refer to the part number breakdown charts. Please contact us if you need any further assistance.

Simple steps to guide you in using this catalogue

- 1) Identify the product group listed in Contents on page 1 and go directly to that page number.
- 2) Each product group cover page then details information and options available.
- 3) Refer to the product detail pages and identify the product you require pictorially.
- 4) Read the product description column for the products standard features.
- 5) Use variations column to determine your choice.
- 6) Identify part number.
- 7) In the event the particular option you require is not listed please refer to the part number breakdown page at the end of each section.
- 8) Please contact us directly if you have any further problems.

XLR Connectors

AC Series Dual 1/4" (6.35mm) / XLR Chassis Mount



Features:

- Two connectors in the one housing.
- Low profile design offers a 15% space saving over the traditional design.
- Vertical or Horizontal PCB mounting.
- Bulk packed in trays, 100 to a box as standard.
- Positive latch lock system (XLR).

Part Number Breakdown: [Page 63](#)

Specifications: [Page 65](#)









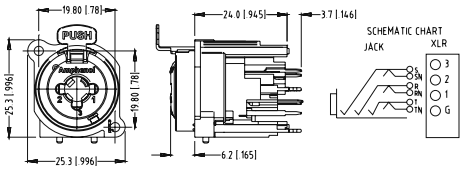

PCB Footprints: [Page 64](#)

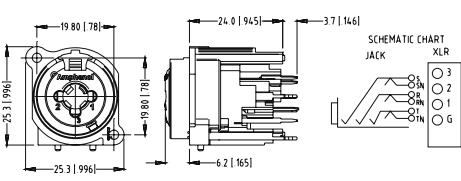
Recommended Fastener: [Page 154](#)

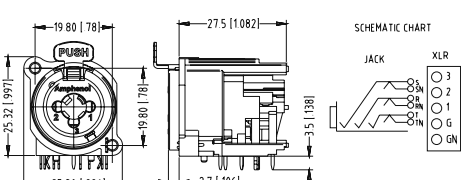
PRODUCT - FIGURE	DRAWING	Dimensions in mm (inches)	DESCRIPTION	VARIATIONS	PART NUMBER
			Low Profile XLR 3 pole female receptacle with 1/4" stereo jack without switching contact, Horizontal PCB mount, Bulk Pack	Latching	ACJC6AH BULK
			Low Profile XLR 3 pole female receptacle with 1/4" stereo jack without switching contact, Horizontal PCB mount, Bulk Pack	Non-latching, Retention Spring	ACJC6AHL BULK
			Low Profile XLR 3 pole female receptacle with 1/4" stereo jack without switching contact, Vertical PCB mount, Bulk Pack	Latching	ACJC6AV2 BULK
			Low Profile XLR 3 pole female receptacle with 1/4" stereo jack without switching contact, Vertical PCB mount, Bulk Pack	Non-latching, Retention Spring	ACJC6AV2L BULK
			Low Profile XLR 3 pole female receptacle with 1/4" switching stereo jack, Horizontal PCB mount, Bulk Pack	Latching	ACJC9AH BULK
			Low Profile XLR 3 pole female receptacle with 1/4" switching stereo jack, Horizontal PCB mount, Bulk Pack	Non-latching, Retention Spring	ACJC9AHL BULK

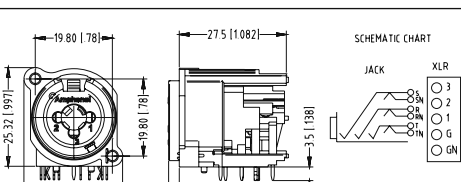
XLR Connectors

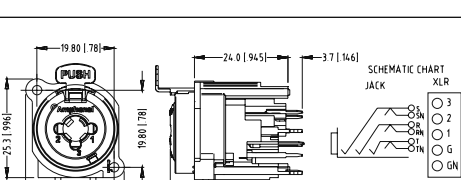
AC Series Dual 1/4" (6.35mm) / XLR Chassis Mount

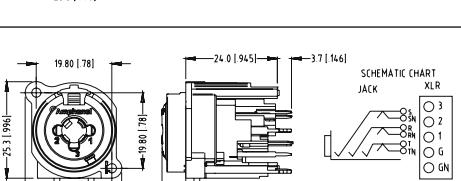
PRODUCT - FIGURE	DRAWING	Dimensions in mm (inches)	DESCRIPTION	VARIATIONS	PART NUMBER
		19.80 [78] 25.3 [996] 19.80 [78] 25.3 [996] 24.0 [945] 3.7 [146] 6.2 [165]	Low Profile XLR 3 pole female receptacle with 1/4" switching stereo jack, Vertical PCB mount, Bulk Pack	Latching	ACJC9AV2 BULK
		19.80 [78] 25.3 [996] 19.80 [78] 25.3 [996] 24.0 [945] 3.7 [146] 6.2 [165]	Low Profile XLR 3 pole female receptacle with 1/4" switching stereo jack, Vertical PCB mount, Bulk Pack	Non-latching, Retention Spring	ACJC9AV2L BULK
		19.80 [78] 25.32 [997] 19.80 [78] 25.30 [996] 27.5 [1082] 2.7 [106] 3.5 [138]	Low Profile XLR 3 pole female receptacle with 1/4" switching stereo jack and switching ground contact, Horizontal PCB mount, Bulk Pack	Latching	ACJC10AH BULK
		19.80 [78] 25.32 [997] 19.80 [78] 25.30 [996] 27.5 [1082] 2.7 [106] 3.5 [138]	Low Profile XLR 3 pole female receptacle with 1/4" switching stereo jack and switching ground contact, Horizontal PCB mount, Bulk Pack	Non-latching, Retention Spring	ACJC10AHL BULK
		19.80 [78] 25.3 [996] 19.80 [78] 25.3 [996] 24.0 [945] 3.7 [146] 6.2 [165]	Low Profile XLR 3 pole female receptacle with 1/4" switching stereo jack and switching ground contact, Vertical PCB mount, Bulk Pack	Latching	ACJC10AV2 BULK
		19.80 [78] 25.3 [996] 19.80 [78] 25.3 [996] 24.0 [945] 3.7 [146] 6.2 [165]	Low Profile XLR 3 pole female receptacle with 1/4" switching stereo jack and switching ground contact, Vertical PCB mount, Bulk Pack	Non-latching, Retention Spring	ACJC10AV2L BULK

XLR Connectors

AC Series Dual 1/4" (6.35mm) / XLR Chassis Mount

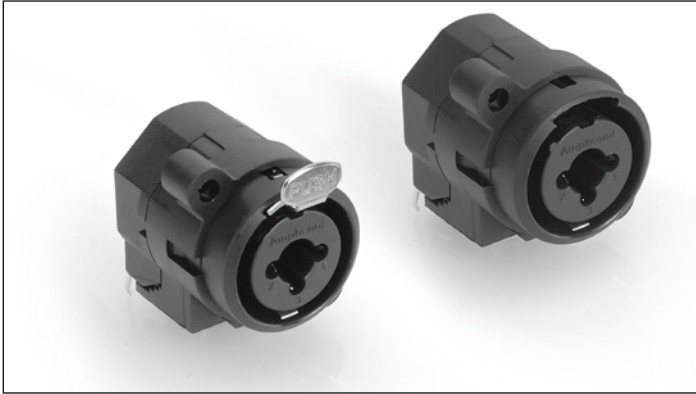

Features:

- Two connectors in the one housing.
- Space saving design.
- Industry standard PCB footprint layout.
- Vertical or Horizontal PCB mounting.
- Bulk packed in trays, 100 to a box as standard.
- Positive latch lock system (XLR).

Part Number Breakdown: Page 63

Specifications: Page 65











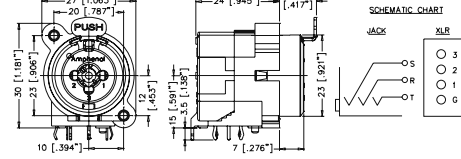

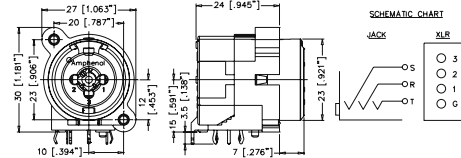

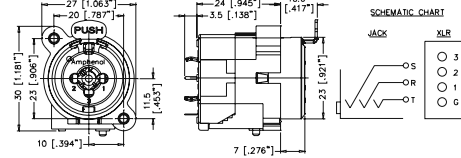
PCB Footprints: Page 64

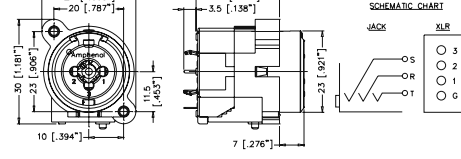
Recommended Fastener: Page 154

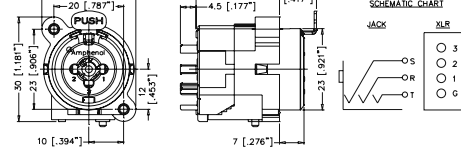
PRODUCT - FIGURE	DRAWING	Dimensions in mm (inches)	DESCRIPTION	VARIATIONS	PART NUMBER
		27 [1.063] 20 [0.787] 30 [1.181] 23 [0.906] 10 [.394] 12 [.472] 24 [.945] 10.6 [.417] 23 [.921] 7 [.276] 19 [.750] 3.5 [0.138]	XLR 3 pole female receptacle with 1/4" mono jack without switching contact, Horizontal PCB mount, Bulk Pack	Latching	ACJC5H BULK
		27 [1.063] 20 [0.787] 30 [1.181] 23 [0.906] 10 [.394] 12 [.472] 24 [.945] 10.6 [.417] 23 [.921] 7 [.276] 19 [.750] 3.5 [0.138]	XLR 3 pole female receptacle with 1/4" mono jack without switching contact, Horizontal PCB mount, Bulk Pack	Non-latching, Retention Spring	ACJC5HL BULK
		27 [1.063] 20 [0.787] 30 [1.181] 23 [0.906] 10 [.394] 12 [.472] 24 [.945] 10.6 [.417] 23 [.921] 7 [.276] 19 [.750] 3.5 [0.138]	XLR 3 pole female receptacle with 1/4" mono jack without switching contact, Vertical PCB mount, Bulk Pack	Latching	ACJC5V BULK
		27 [1.063] 20 [0.787] 30 [1.181] 23 [0.906] 10 [.394] 11.5 [.453] 24 [.945] 3.5 [0.138] 23 [.921] 7 [.276]	XLR 3 pole female receptacle with 1/4" mono jack without switching contact, Vertical PCB mount, Bulk Pack	Non-latching, Retention Spring	ACJC5VL BULK
		27 [1.063] 20 [0.787] 30 [1.181] 23 [0.906] 10 [.394] 12 [.472] 24 [.945] 10.6 [.417] 23 [.921] 7 [.276] 4.5 [0.177]	XLR 3 pole female receptacle with 1/4" mono jack without switching contact, Solder Contacts, Bulk Pack	Latching	ACJC5S BULK
		27 [1.063] 20 [0.787] 30 [1.181] 23 [0.906] 10 [.394] 12 [.472] 24 [.945] 4.5 [0.177] 23 [.921] 7 [.276]	XLR 3 pole female receptacle with 1/4" mono jack without switching contact, Solder Contacts, Bulk Pack	Non-latching, Retention Spring	ACJC5SL BULK

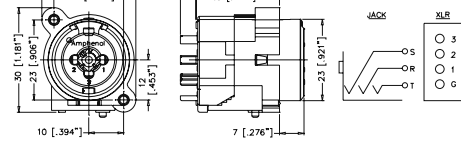

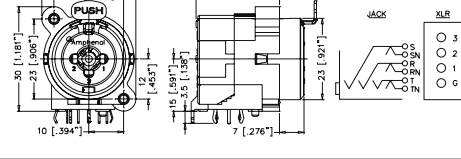

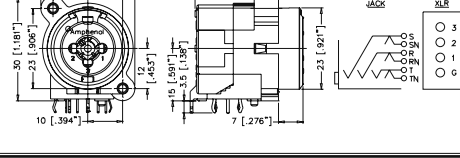





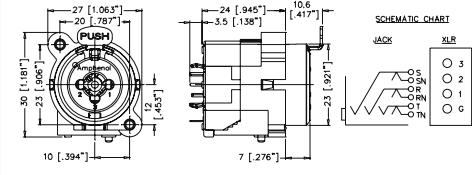

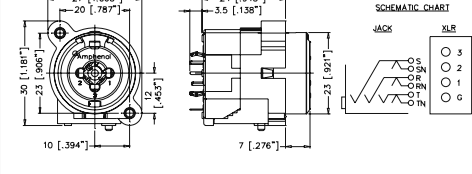

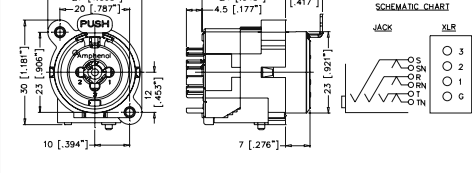
XLR Connectors

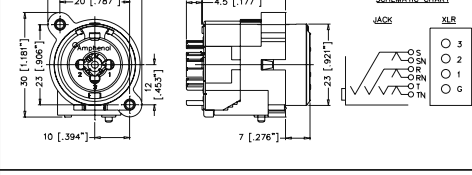

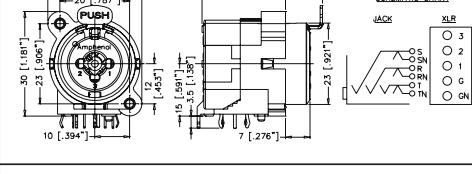
AC Series Dual 1/4" (6.35mm) / XLR Chassis Mount

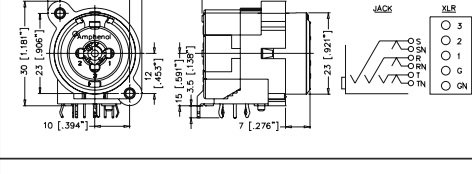
PRODUCT - FIGURE	DRAWING	DESCRIPTION	VARIATIONS	PART NUMBER
		XLR 3 pole female receptacle with 1/4" stereo jack without switching contact, Horizontal PCB mount, Bulk Pack	Latching	ACJC6H BULK
		XLR 3 pole female receptacle with 1/4" stereo jack without switching contact, Horizontal PCB mount, Bulk Pack	Non-latching, Retention Spring	ACJC6HL BULK
		XLR 3 pole female receptacle with 1/4" stereo jack without switching contact, Vertical PCB mount, Bulk Pack	Latching	ACJC6V BULK
		XLR 3 pole female receptacle with 1/4" stereo jack without switching contact, Vertical PCB mount, Bulk Pack	Non-latching, Retention Spring	ACJC6VL BULK
		XLR 3 pole female receptacle with 1/4" stereo jack without switching contact, Solder Contacts, Bulk Pack	Latching	ACJC6S BULK
		XLR 3 pole female receptacle with 1/4" stereo jack without switching contact, Solder Contacts, Bulk Pack	Non-latching, Retention Spring	ACJC6SL BULK
		XLR 3 pole female receptacle with 1/4" switching stereo jack, Horizontal PCB mount, Bulk Pack	Latching	ACJC9H BULK
		XLR 3 pole female receptacle with 1/4" switching stereo jack, Horizontal PCB mount, Bulk Pack	Non-latching, Retention Spring	ACJC9HL BULK

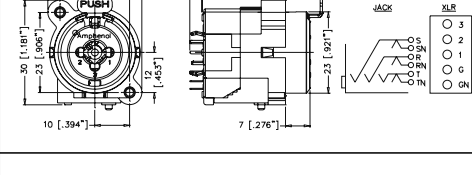
XLR Connectors

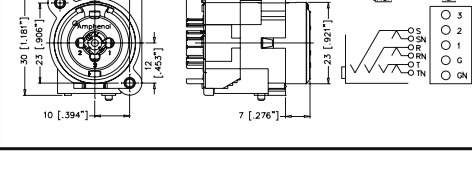
AC Series Dual 1/4" (6.35mm) / XLR Chassis Mount

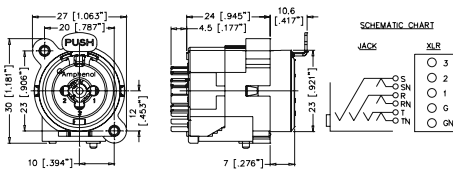
PRODUCT - FIGURE	DRAWING	DESCRIPTION	VARIATIONS	PART NUMBER
		XLR 3 pole female receptacle with 1/4" switching stereo jack, Vertical PCB mount, Bulk Pack	Latching	ACJC9V BULK
		XLR 3 pole female receptacle with 1/4" switching stereo jack, Vertical PCB mount, Bulk Pack	Non-latching, Retention Spring	ACJC9VL BULK
		XLR 3 pole female receptacle with 1/4" switching stereo jack, Solder Contacts, Bulk Pack	Latching	ACJC9S BULK
		XLR 3 pole female receptacle with 1/4" switching stereo jack, Solder Contacts, Bulk Pack	Non-latching, Retention Spring	ACJC9SL BULK
		XLR 3 pole female receptacle with 1/4" switching stereo jack and switching ground contact, Horizontal PCB mount, Bulk Pack	Latching	ACJC10H BULK
		XLR 3 pole female receptacle with 1/4" switching stereo jack and switching ground contact, Horizontal PCB mount, Bulk Pack	Non-latching, Retention Spring	ACJC10HL BULK
		XLR 3 pole female receptacle with 1/4" switching stereo jack and switching ground contact, Vertical PCB mount, Bulk Pack	Latching	ACJC10V BULK
		XLR 3 pole female receptacle with 1/4" switching stereo jack and switching ground contact, Vertical PCB mount, Bulk Pack	Non-latching, Retention Spring	ACJC10VL BULK

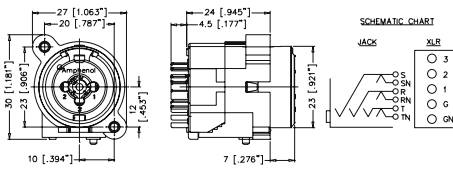
PRODUCT - FIGURE	DRAWING	DESCRIPTION	VARIATIONS	PART NUMBER
		XLR 3 pole female receptacle with 1/4" switching stereo jack and switching ground contact, Solder Contacts, Bulk Pack	Latching	ACJC10S BULK
		XLR 3 pole female receptacle with 1/4" switching stereo jack and switching ground contact, Solder Contacts, Bulk Pack	Non-latching, Retention Spring	ACJC10SL BULK

PART NUMBER BREAKDOWN

AC SERIES THERMOPLASTIC C TYPE

E. G. **ACJC5HL BULK**
AC (Series Prefix), **JC** Jack/Connector XLR, **5** Mono, **H**orizontal Printed Circuit Board, **L**atchless, **BULK** Packaged.

SERIES PREFIX
 CONNECTOR TYPE
 CONTACT OPTIONS
 HOUSING TYPE
 CONTACT ORIENTATION
 LOCKING MECHANISM
 PACKAGING

AC JC 5 H L BULK

SERIES PREFIX	AC = Series Prefix
CONNECTOR TYPE	JC = Jack / Connector XLR
CONTACT OPTIONS	5 = Mono, Non Switching, XLR Grounded 6 = Stereo, Non Switching, XLR Grounded 9 = Stereo, Switching, XLR Grounded 10 = Stereo, Switching, XLR with Ground Switch
HOUSING TYPE	Blank = Standard A = Low Profile / High Density
CONTACT TYPE	V = Vertical Printed Circuit Board V2 = Vertical Printed Circuit Board (24mm) H = Horizontal Printed Circuit Board S = Solder Contacts
LOCKING MECHANISM	Blank = Latching L = Latchless
PACKAGING	Blank = Individual Bags BULK = Bulk Packed PRD = Disassembled push lever

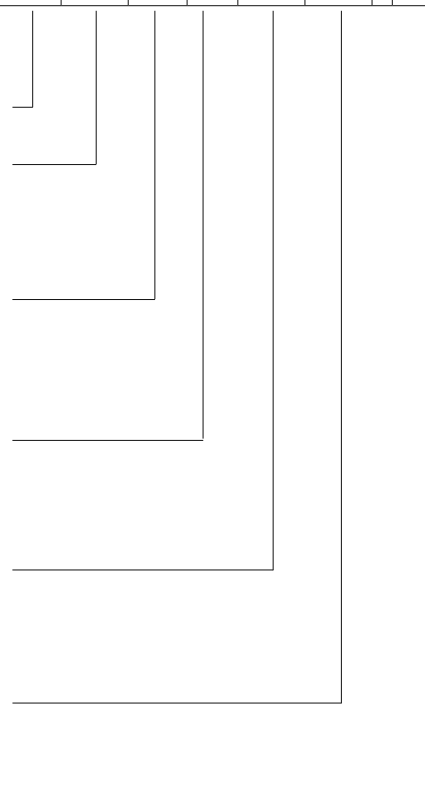

XLR Connectors

AC Series Dual 1/4" (6.35mm) / XLR Chassis Mount

AC SERIES C TYPE SERIES

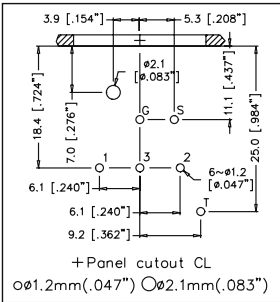

ACJC5H & ACJC5HL

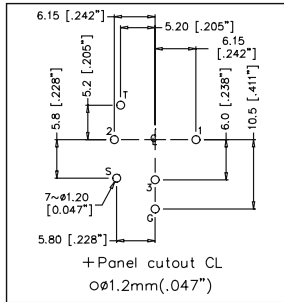

ACJC5V & ACJC5VL

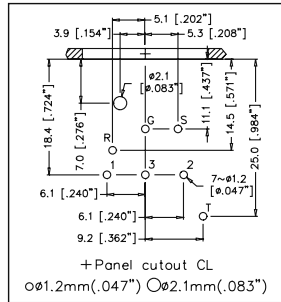

ACJC6H & ACJC6HL

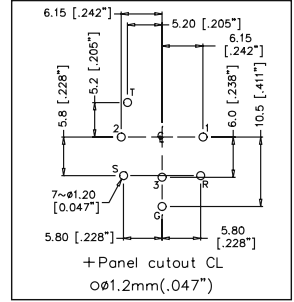

ACJC6V & ACJC6VL

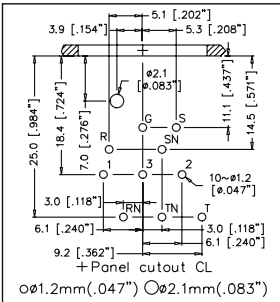

ACJC9H & ACJC9HL

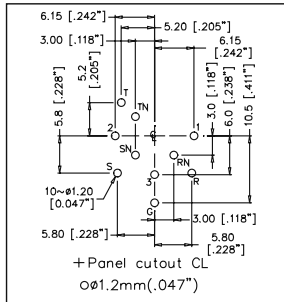

ACJC9V & ACJC9VL

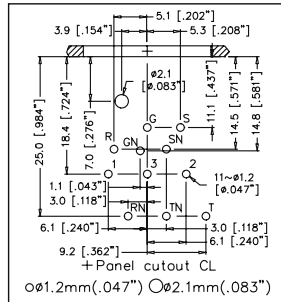

ACJC10H & ACJC10HL

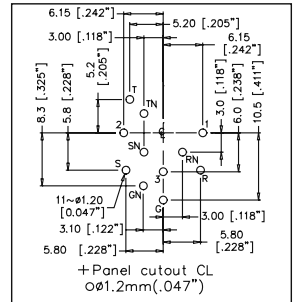

ACJC10V & ACJC10VL

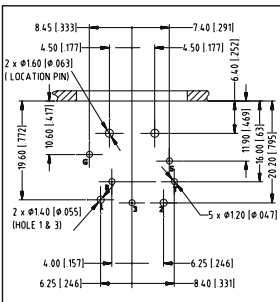

ACJC6AH & ACJC6AHL

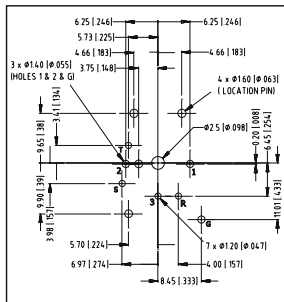

ACJC6AV2 & ACJC6AV2L

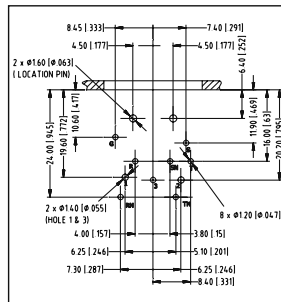

ACJC9AH & ACJC9AHL

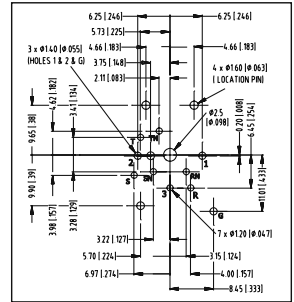

ACJC9AV2 & ACJC9AV2L

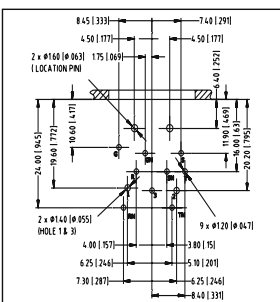

ACJC10AH & ACJC10AHL

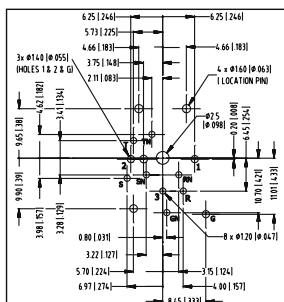

ACJC10AV2 & ACJC10AV2L

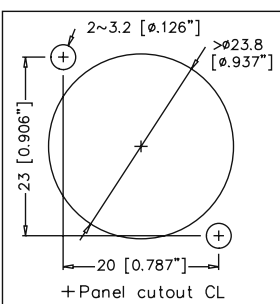

C TYPE PANEL CUTOUT

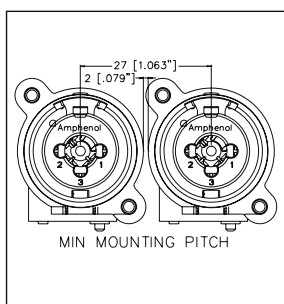

C TYPE MOUNTING PITCH

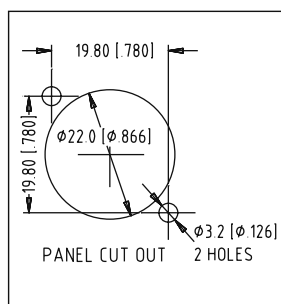

C TYPE LOW PROFILE PANEL CUTOUT

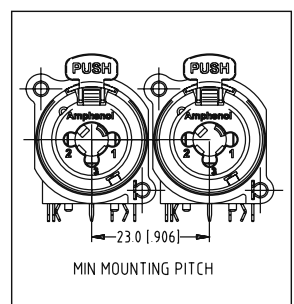

C TYPE LOW PROFILE MOUNTING PITCH

STANDARD DATA C TYPE CHASSIS RECEPTACLES

		VALUE	
		LOW PROFILE TYPE	STANDARD C TYPE
GENERAL CHARACTERISTICS	Number of contacts	5, 6, 9 or 10	
	Termination	Printed Circuit Board (PCB)	Printed Circuit Board (PCB) or Solder Bucket
	Flammability	UL 94HB	
	Environmental	Complies with EU RoHS 2 Directive 2011/65/EU	
ELECTRICAL CHARACTERISTICS	Service Voltage RMS	50V	
	Test Voltage AC RMS	1500V	
	Current carrying capacity	7.5A	
	Typical Contact Resistance	≤50mΩ	
	Insulation Resistance (initial)	> 0.5GΩ	
	Insulation Resistance (after damp heat test)	> 0.2GΩ	
CLIMATIC CHARACTERISTICS	Protection Class	IP40	
	Operating Temperature	-25 °C to +70 °C	
MECHANICAL CHARACTERISTICS	Weight**	9.2g (0.02lb)	14g (0.030lb)
	Retention Spring separating force	≥20N	
	Mounting Screw torque max.	1.5Nm	
	Mechanical Operations	1500 mating cycles	
	Fastening***	Self-Tapping PT screw with thread 2.9 x 1.06 and of Tri-rondular configuration	
MATERIALS	Connector Shell	PA6.6 + 30% glass fibre reinforced, UL94HB	PA6.6 + 20% glass fibre reinforced, UL94HB
	Shell Finish		Black
	Insulators	PA6.6 glass fibre reinforced, UL94HB	PA6.6 + 20% glass fibre reinforced, UL94HB
	XLR Contact		
	Material	Bronze	
	Plating	Gold over Nickel plated	
	Jack Contact		
	Material	Bronze	Brass
Plating	Gold over Nickel plated	Silver over Copper plated	
Latch lock and Spring	Nickel Plated		
Ground element	Nickel Plated	Silver over Copper plated	

**Approximate weight in grams not including packaging. Please contact us for exact weight for shipping purposes.

***Refer to Page 154

Rev 6 - 03/2013

XLR Connectors

G-Type Miniature XLR Connectors



G-TYPE MINIATURE XLR CONNECTORS



Features:

- Miniature version of the standard XLR series
- Diecast or Precision machined metal housings
- Metal cable clamp
- Precision machined pin contacts
- Stamped socket contacts
- Solder cup or Printed Circuit board contacts
- Available in 3, 4, 5 or 6 contacts
- Postive latchlock
- Flexible cable grommet

Part Number Breakdown: Page 67
PCB Footprints: Page 69

Specifications: Page 68
Panel Cutouts: Page 69

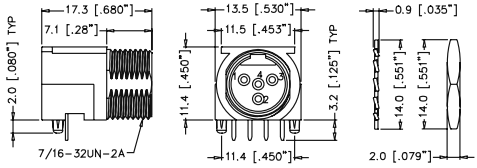
PRODUCT - FIGURE	DRAWING	Dimensions in mm (inches)	DESCRIPTION	VARIATIONS	PART NUMBER
			Male cable connector, Machined contacts, Nickel Finish	3 pole 4 pole 5 pole 6 pole	AG3M AG4M AG5M AG6M
			Female cable connector, Stamped contacts, Nickel Finish	3 pole 4 pole 5 pole 6 pole	AG3F AG4F AG5F AG6F
			Female cable connector with locking ring, Stamped contacts, Nickel Finish.	3 pole 4 pole 5 pole 6 pole	AG3FL AG4FL AG5FL AG6FL
			Male chassis connector, Machined contacts, Nickel Finish	3 pole 4 pole 5 pole 6 pole	AG3MCC AG4MCC AG5MCC AG6MCC
			Female chassis connector, Stamped contacts, Nickel Finish	3 pole 4 pole 5 pole 6 pole	AG3FCE AG4FCE AG5FCE AG6FCE
			Male chassis connector, Horizontal PCB, Machined contacts, Nickel Finish	3 pole 4 pole 5 pole 6 pole	AG3MCCCH AG4MCCCH AG5MCCCH AG6MCCCH
			Female chassis connector, Horizontal PCB, Stamped contacts, Nickel Finish	3 pole 4 pole 5 pole 6 pole	AG3FCCH AG4FCCH AG5FCCH AG6FCCH

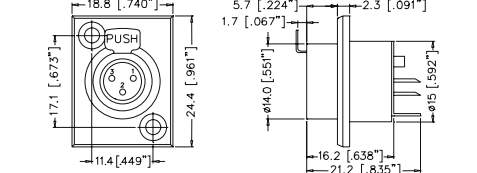
		<p>Male chassis connector, Horizontal PCB, Machined contacts, Thermoplastic shell</p>	<p>4 pole</p>	<p>AG4MPCH</p>
		<p>Female chassis connector, Stamped contacts, Nickel Finish</p>	<p>3 pole</p>	<p>AG3FCRV</p>
			<p>4 pole</p>	<p>AG4FCRV</p>
			<p>5 pole</p>	<p>AG5FCRV</p>
			<p>6 pole</p>	<p>AG6FCRV</p>

PART NUMBER BREAKDOWN

G TYPE CONNECTORS

E. G. **AG3MCCHB**
AG (Series Prefix), **3** contacts, **Male**, **Chassis Connector**, **Horizontal PCB Contacts**, **Black finish**.

SERIES PREFIX	AG	=	Series Prefix
CONTACT LAYOUTS	3	=	3 Contacts
	4	=	4 Contacts
	5	=	5 Contacts
	6	=	6 Contacts
GENDER	F	=	Female Socket Contacts
	M	=	Male Pin Contacts
	Blank	=	Cable Connector Standard (Male or Female)
SHELL STYLE	J	=	Cable Connector Large Cable clamp / boot O.D (Male or Female)
	L	=	Cable Connector with locking ring (Female)
	LL	=	Latchless (Chassis Connector)
	CC	=	Chassis Connector Circular Metal (Male)
	CE	=	Rear Mount (Chassis Connector)
	CM	=	Mid Mount (Chassis Connector)
	CR	=	Chassis Connector Rectangular Metal (Female)
	PC	=	Chassis Connector Plastic (Male)
	Blank	=	Solder Buckets (All styles except PC, CR)
CONTACT TYPE	H	=	Horizontal PCB (Style CC, PC only)
	V	=	Vertical PCB (Style CR only)
	Blank	=	Nickel Plated Finish
SHELL FINISH	B	=	Black Finish

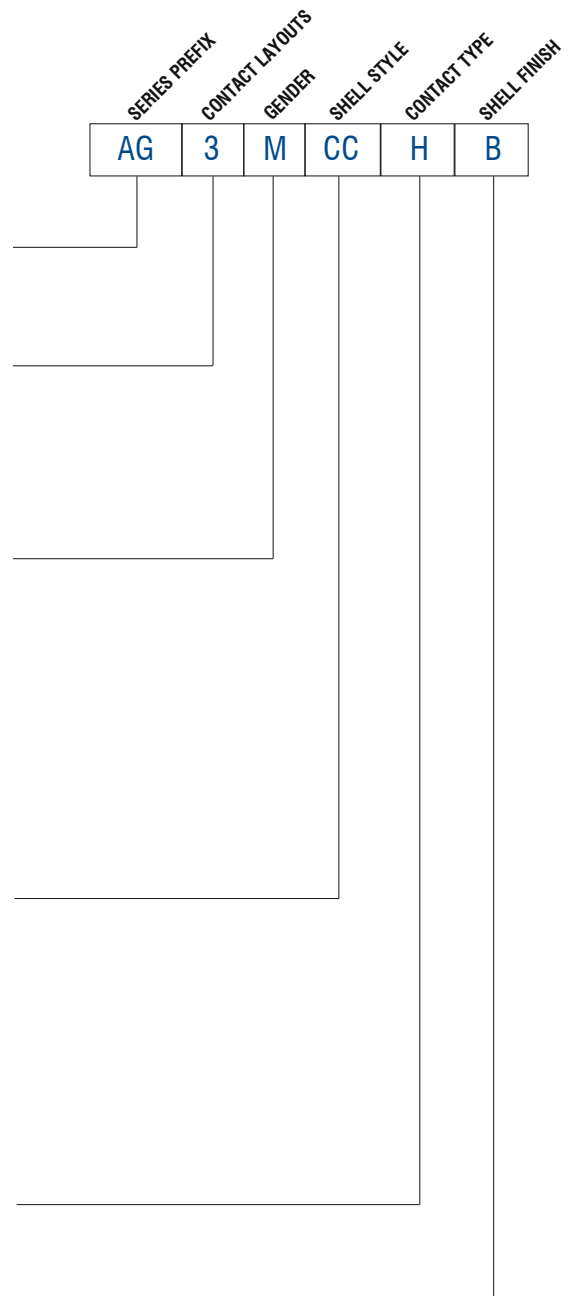

XLR Connectors

G-Type Miniature XLR Connectors

STANDARD DATA G TYPE

		VALUE			
GENERAL CHARACTERISTICS	Number of Contacts	3	4	5	6
	Termination	Printed Circuit Board (PCB) or Solder Bucket			
	Max. Wire Gauge - Stranded Wire	AWG 24 - 0.2mm ²			AWG 28 - 0.08mm ²
	Flammability	UL94V-HB			
	Environmental	Complies with EU RoHS 2 Directive 2011/65/EU			
ELECTRICAL CHARACTERISTICS	Current Carrying Capacity	5A	5A	4A	1.2A
	Typical Contact Resistance	≤10mΩ			
	Insulation resistance (initial) After Damp Heat Test	≥510MΩ ≥10MΩ			
	Dielectric Strength	1000 V dc			250 V dc
CLIMATIC CHARACTERISTICS	Protection Class	IP00			
	Operating Temperature	-30 °C to +80 °C (-20F - +176F)			
MECHANICAL CHARACTERISTICS	Insertion Spring Separating Force	≥20N			
	Cable O.D.	Standard	2mm to 3.5mm (0.078" to 0.137")		
		Large clamp / boot (Option "J")	3mm to 5mm (0.118" to 0.196")		
	Mechanical Operations	5000 mating cycles			2000 mating cycles
	Weight	13.5g (0.029lb)			
MATERIALS	Connector Shell	Bronze & Zinc			
	Connector Shell Finish	Nickel Plated			
	Insulators	PPS - Black			
	Male Contact	Material - Brass C3604 Plating - Gold over Silver Plated			
	Female Contact	Material - Brass C5210P Plating - Gold over Silver Plated			
	Latch Lock and Spring	SUS (AISI - 301) - Nickel Plated			
	Adaptor	PPS - Black			
	Cable Clamp	Bronze - Nickel Plated			
	Boot/Backshell	ABS - Black			
	Grommet	PU - Black			

Rev 7 - 09/2023

¹⁾ Approximate weight only, does not include packaging. Please contact us for exact weight for shipping purposes.
Not suitable for voltages over 50V.

PANEL CUTOUTS - CONNECTOR SIDE OF PCB

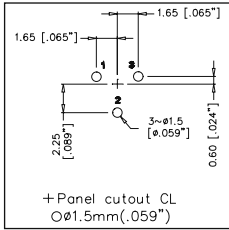

AG3MCC

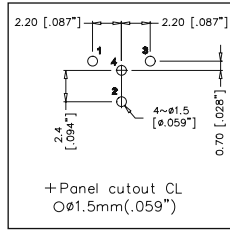

AG4MCC

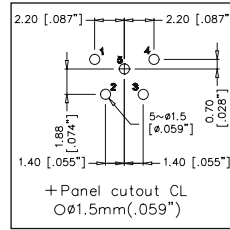

AG5MCC

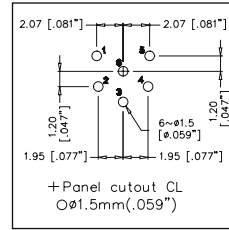

AG6MCC

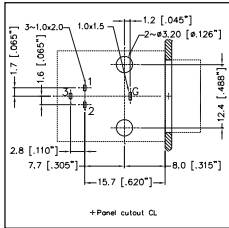

AG3FCCH

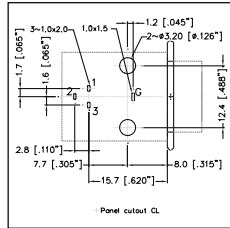

AG3MCCCH

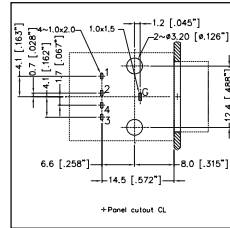

AG4FCCH

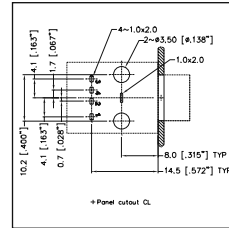

AG4MCCCH

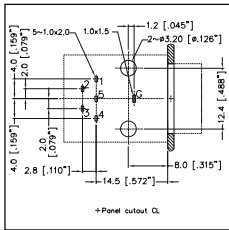

AG5FCCH

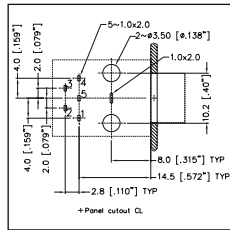

AG5MCCCH

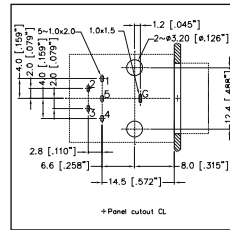

AG6FCCH

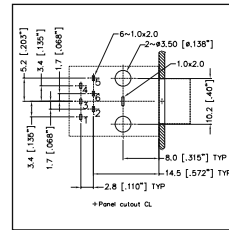

AG6MCCCH

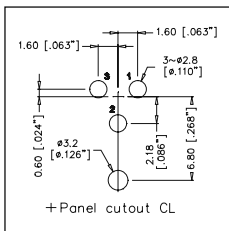

AG3FCRV

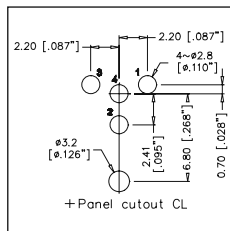

AG4FCRV

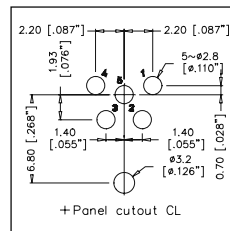

AG5FCRV

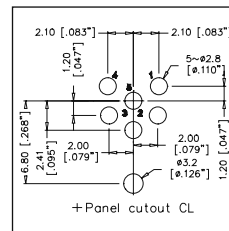

AG6FCRV

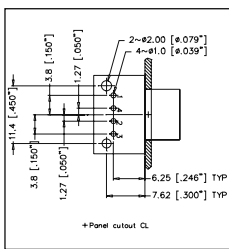

AG4MPCH

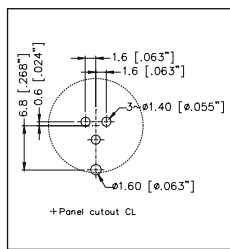

AG3FCE

PANEL CUTOUTS - FRONT VIEW

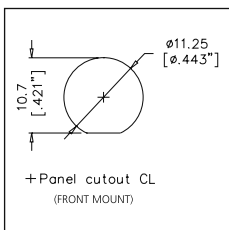

**AG3MCC
AG4MCC
AG5MCC
AG6MCC**

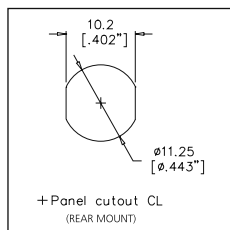

**AG3MCCCH
AG4MCCCH
AG5MCCCH
AG6MCCCH
AG4MPCH**

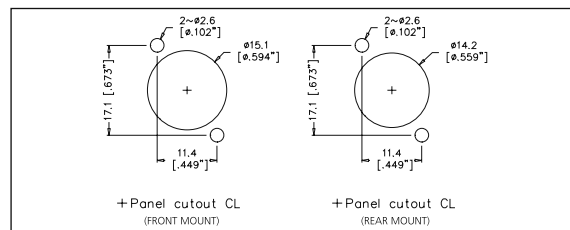

**AG3FCRV
AG4FCRV
AG5FCRV
AG6FCRV**

Speaker Connectors

G-Type Miniature XLR Connectors



SP/EP/AP SERIES LOUDSPEAKER CONNECTORS

SP Series

The SP Series are available in 2 or 4 pole chassis mount connectors. The durable thermoplastic housings are fitted with high power contacts to ensure optimal current carrying capacity. Completely intermatable with industry standard loudspeaker connections.

Features

- High current contacts for distortion free signal.
- Cost effective durable thermoplastic shell
- Available in 2 and 4 contact arrangements.
- Overmolded cable support boot or PG gland with or without cable support strain relief.
- Quick release, vibration resistant latch lock.
- UL, cUL recognized components (File no. E339831)
- Precision machined contacts
- Thermoplastic shell

Options

- Solder termination / Tab or Printed Circuit Board versions, Screw Terminals
- Nickel Plated Zinc Alloy shell
- Black finished Zinc Alloy shell

EP Series

The EP Series incorporates a rugged zinc diecast shell to give it maximum durability when used in demanding situations. The EP cable connector cable flex relief design minimises cable bend stress at point of entry into the connector housing.

Features

- High current contacts for distortion free signal.
- Tough, durable zinc diecast shell
- Cable clamp capable of supporting cables from 9mm (0.35") to 16mm (0.63") in diameter.
- Quick release, vibration resistant latch lock.
- AP & EP series are completely intermatable.
- Precision machined contacts

Options

- Nickel Plated Zinc Alloy shell
- Black finished Zinc Alloy shell
- Available in 3, 4, 5, 6 and 8 contact arrangements

AP Series

The AP Series Shell is manufactured from tough, durable thermoplastic, and ideal for fixed indoor installations. Both the EP and AP Series utilise the same contact and insulator components.

Features

- High current contacts for distortion free signal.
- Cost effective durable thermoplastic shell
- Quick release, vibration resistant latch lock.
- AP & EP series are completely intermatable.
- Precision machined contacts
- Thermoplastic shell

Options

- Available in 4, 5, 6, and 8 contact arrangements.

Ordering Codes

We have listed the more common ordering codes in each section. Please contact us if you need any further assistance.

Simple steps to guide you in using this catalogue

- 1) Identify the product group listed in Contents on page 1 and go directly to that page number.
- 2) Each product group cover page then details information and options available.
- 3) Refer to the product detail pages and identify the product you require pictorially.
- 4) Read the product description column for the products standard features.
- 5) Use variations column to determine your choice.
- 6) Identify part number.
- 7) In the event the particular option you require is not listed please refer to the part number breakdown page at the end of each section.
- 8) Please contact us directly if you have any further problems.

SP SERIES

Amphenol's range of loudspeaker connectors have been further enhanced with the introduction of the SP Series. Designed to complement the popular EP/AP Series, we now offer a range of loudspeaker connectors to suit most applications. SP Series chassis connectors are available in industry standard PCB footprints with solder tabs. SP Series cable plugs are available with screw or solder terminals.

Features:

- Quick release, vibration resistant latch lock
- 2 or 4 pole
- Solder tabs, PCB Contacts, Solder or Screw Terminals
- Chuck type or PG Gland cable clamp
- Various mounting hole options
- 20A Current rating
- Thermoplastic or Metal housing (Cable Plugs)
- UL, cUL recognized components (File no. E339831)
- Industry standard mating



Part Number Breakdown: Page 75
PCB Footprints: Page 77









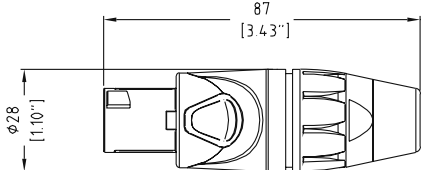

Specifications: Page 79
Assembly Instructions: 78

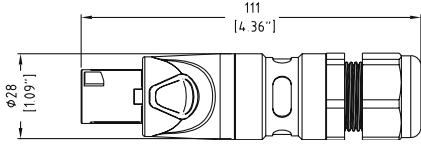

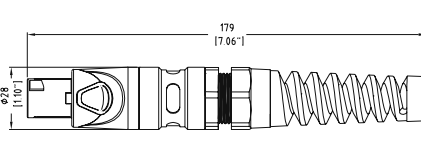
PRODUCT - FIGURE	DRAWING	DESCRIPTION	CONTACT TYPE	SHELL COLOUR	PART NUMBER
		2 pole, Cable connector, Thermoplastic shell, Blue sleeve	Screw	Black	SP-2-F
			Torx	Black	SP-2-FTX
			Solder	Black	SP-2-FS
		2 pole, Cable connector, Thermoplastic shell, Blue sleeve, PG Gland	Screw	Black	SP-2-FG
			Torx	Black	SP-2-FGTX
			Solder	Black	SP-2-FSG
		2 pole, Cable connector, Thermoplastic shell, Blue sleeve, PG Gland strain relief	Screw	Black	SP-2-FL
			Torx	Black	SP-2-FLTX
			Solder	Black	SP-2-FSL
		2 pole, Cable connector, Metal shell, Blue sleeve	Screw	Nickel	SP-2-FN
			Torx	Nickel	SP-2-FNTX
			Solder	Nickel	SP-2-FNS
			Screw	Black	SP-2-FB
			Torx	Black	SP-2-FBTX
			Solder	Black	SP-2-FBS
		2 pole, Cable connector, Metal shell, Blue sleeve, PG Gland	Screw	Nickel	SP-2-FNG
			Torx	Nickel	SP-2-FNGTX
			Solder	Nickel	SP-2-FNSG
			Screw	Black	SP-2-FBG
			Torx	Black	SP-2-FBGTX
			Solder	Black	SP-2-FBSG
		2 pole, Cable connector, Metal shell, Blue sleeve, PG Gland strain relief	Screw	Nickel	SP-2-FNL
			Torx	Nickel	SP-2-FNLTX
			Solder	Nickel	SP-2-FNSL
			Screw	Black	SP-2-FBL
			Torx	Black	SP-2-FBLTX
			Solder	Black	SP-2-FBSL

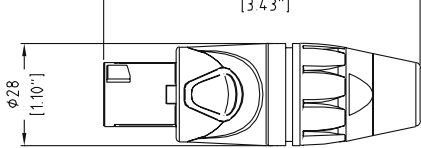
Speaker Connectors

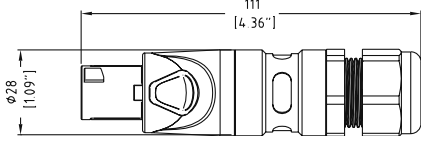
SP Series

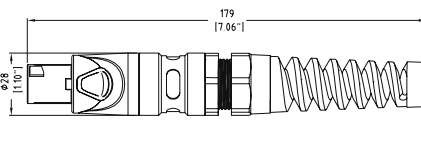
PRODUCT - FIGURE	DRAWING	DESCRIPTION	CONTACT TYPE	SHELL COLOUR	PART NUMBER
	 <p>Dimensions in mm (inches)</p> <p>87 [3.43"]</p> <p>φ28 [1.10"]</p>	4 pole, Cable connector, Thermoplastic black shell, Blue sleeve	Screw	Black	SP-4-F
			Torx	Black	SP-4-FTX
			Solder	Black	SP-4-FS
	 <p>111 [4.36"]</p> <p>φ28 [1.09"]</p>	4 pole, Cable connector, Thermoplastic black shell, Blue sleeve, PG Gland	Screw	Black	SP-4-FG
			Torx	Black	SP-4-FGTX
			Solder	Black	SP-4-FSG
	 <p>179 [7.06"]</p> <p>φ28 [1.10"]</p>	4 pole, Cable connector, Thermoplastic black shell, Blue sleeve, PG Gland strain relief	Screw	Black	SP-4-FL
			Torx	Black	SP-4-FLTX
			Solder	Black	SP-4-FSL
	 <p>87 [3.43"]</p> <p>φ28 [1.10"]</p>	4 pole, Cable connector, Metal shell, Blue sleeve	Screw	Nickel	SP-4-FN
			Torx	Nickel	SP-4-FNTX
			Solder	Nickel	SP-4-FNS
			Screw	Black	SP-4-FB
			Torx	Black	SP-4-FBTX
			Solder	Black	SP-4-FBS
	 <p>111 [4.36"]</p> <p>φ28 [1.09"]</p>	4 pole, Cable connector, Metal shell, Blue sleeve, PG Gland	Screw	Nickel	SP-4-FNG
			Torx	Nickel	SP-4-FNGTX
			Solder	Nickel	SP-4-FNSG
			Screw	Black	SP-4-FBG
			Torx	Black	SP-4-FBGTX
			Solder	Black	SP-4-FBSG
	 <p>179 [7.06"]</p> <p>φ28 [1.10"]</p>	4 pole, Cable connector, Metal shell, Blue sleeve, PG Gland strain relief	Screw	Nickel	SP-4-FNL
			Torx	Nickel	SP-4-FNLTX
			Solder	Nickel	SP-4-FNSL
			Screw	Black	SP-4-FBL
			Torx	Black	SP-4-FBLTX
			Solder	Black	SP-4-FBSL











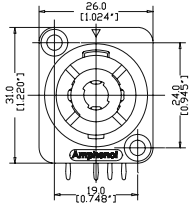



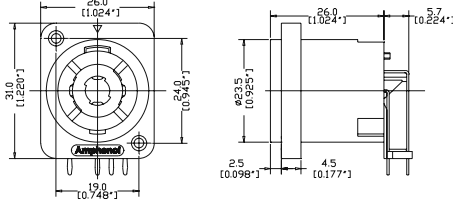

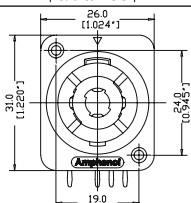

Speaker Connectors

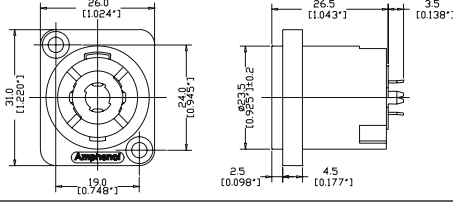
SP Series

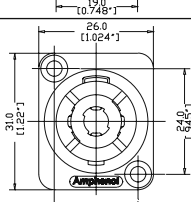
PRODUCT - FIGURE	DRAWING	Dimensions in mm (inches)	DESCRIPTION	VARIATIONS	PART NUMBER
			2 pole, D flange, Thru holes, Solder tabs 3/16"	Black	SP-2-MD
			2 pole, D flange, Thru holes, Horizontal PCB	Black	SP-2-MDH
			2 pole, D flange, Thru holes, Vertical PCB	Black	SP-2-MDV
			Airtight 4 pole, D flange Self Tapping holes, Solder Tabs 3.16"	Black	SP-4-MDAT
			Airtight 4 pole, D flange Thru holes, Solder tabs 3/16"	Black	SP-4-MDA
			4 pole, D flange, Thru holes, Solder tabs 3/16"	Black	SP-4-MD
			4 pole, D flange, Thru holes, Solder tabs 3/16"	Grey	SP-4-MD-8
			4 pole, D flange, Self Tapping holes, Solder tabs 3/16"	Black	SP-4-MDT

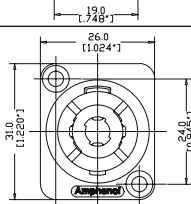
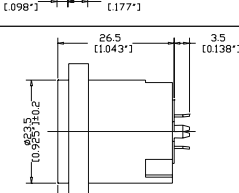
Speaker Connectors

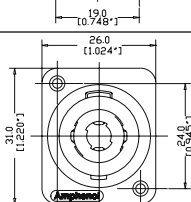
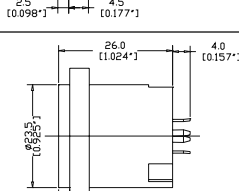
SP Series

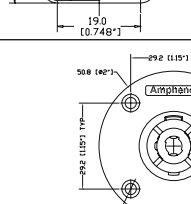
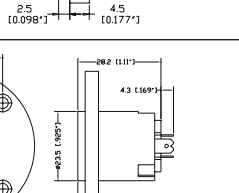
PRODUCT - FIGURE	DRAWING	Dimensions in mm (inches)	DESCRIPTION	VARIATIONS	PART NUMBER
			4 pole, D flange, Thru holes, Horizontal PCB	Black	SP-4-MDH
			4 pole, D flange, Thru holes, Solder tabs 1/4"	Black	SP-4-MDQ
			4 pole, D flange, Self Tapping holes, Horizontal PCB	Grey	SP-4-MDHT-8
			4 pole, D flange, Self Tapping holes, Horizontal PCB	Black	SP-4-MDHT
			4 pole, D flange, Thru holes, Vertical PCB	Black	SP-4-MDV
			4 pole, D flange, Thru holes, Vertical PCB	Red	SP-4-MDV-2
			4 pole, D flange, Self Tapping holes, Vertical PCB	Grey	SP-4-MDVT-8
			4 pole, EP flange, Thru holes, Solder tabs 3/16"	Black	SP-4-MC

PART NUMBER BREAKDOWN

SP SERIES - CABLE CONNECTORS

E. G . **SP-4-FNSG**
SP (Series Prefix), **4** contacts, **F** (Cable Connector), **N** (Metal Shell Nickel Finish),
S (Solder Terminals), **G** (PG Gland)

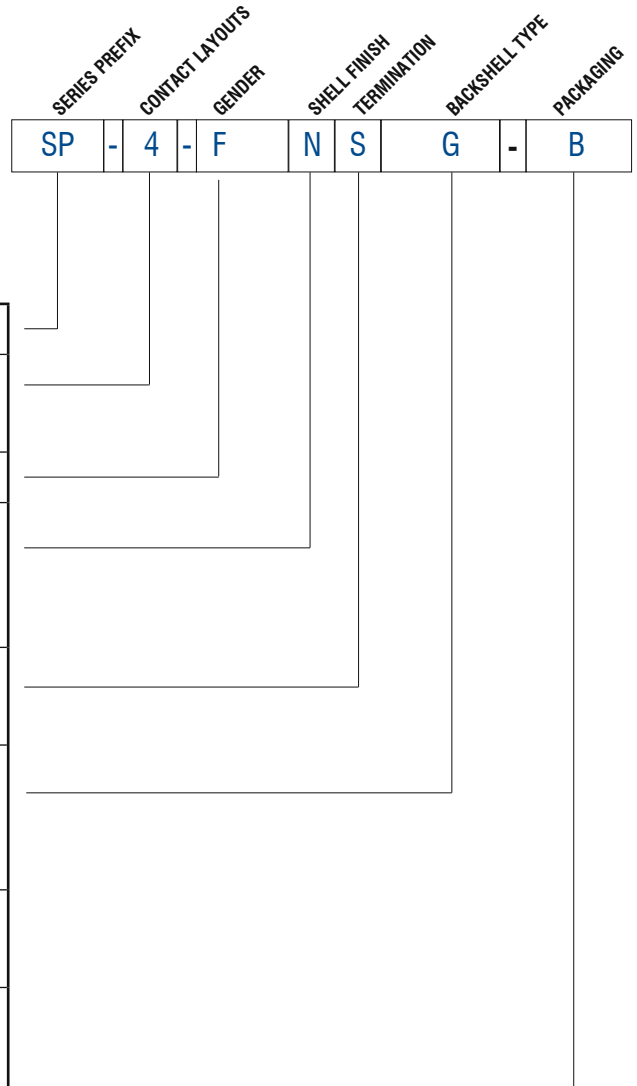

SERIES PREFIX	SP	=	Series Prefix
CONTACT LAYOUT	2	=	2 Contacts
	4	=	4 Contacts
GENDER	F	=	Cable Connector
SHELL FINISH	Blank	=	Thermoplastic - Black
	N	=	Metal - Nickel Finish
	B	=	Metal - Black Finish
TERMINATION	Blank	=	Screw Terminals
	S	=	Solder Terminals
BACKSHELL TYPE	Blank	=	Standard
	G	=	PG Gland
	L	=	PG Gland Strain Relief
SCREW TYPE	Blank	=	Slotted
	TX	=	Torx T8
PACKAGING	Blank	=	Individual Bags
	B	=	Bulk Packed
	B1	=	Supplied with small and large cable clamps

Speaker Connectors

SP Series

PART NUMBER BREAKDOWN

SP SERIES - CHASSIS CONNECTORS

E. G . **SP-4-MDHT-8B**
SP (Series Prefix), **4** contacts, **M**(Chassis Connector), **D** (D Shell), **H**orizontal Printed Circuit Board, **S**elf Tapping mounting holes - **8** (Grey), **B**ulk Packaged.

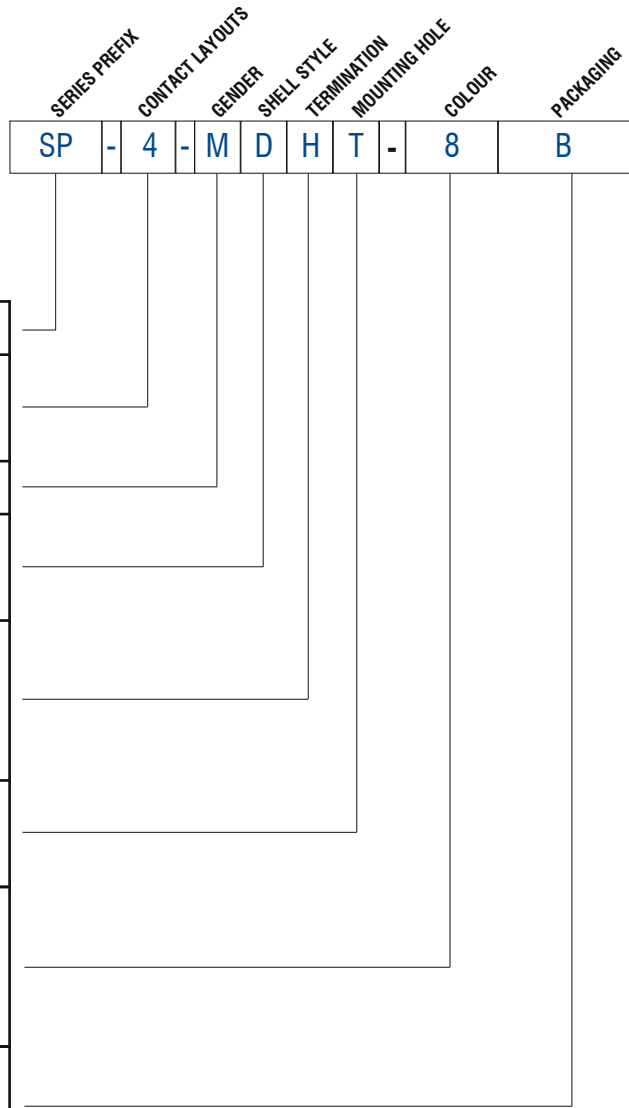

SERIES PREFIX	SP = Series Prefix
CONTACT LAYOUT	2 = 2 Contacts
	4 = 4 Contacts
GENDER	M = Chassis Connector
SHELL STYLE	D = Standard 'D' Type flange
	C = EP Series Circular flange
TERMINATION	Blank = Solder tabs - 3/16" terminals
	Q = Solder tabs - 1/4" terminals
	V = Vertical Printed Circuit Board
	H = Horizontal Printed Circuit Board
MOUNTING HOLE	Blank = Thru Hole
	T = Self Tapping
SHELL COLOUR	Blank = Black
	2 = Red
	8 = Grey
PACKAGING	Blank = Individual Bags
	B = Bulk Packed

SP SERIES

SP-2-MDH

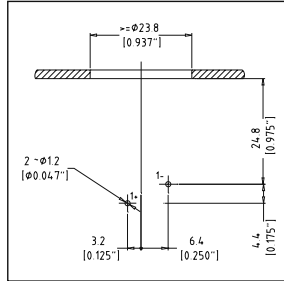

SP-2-MDV

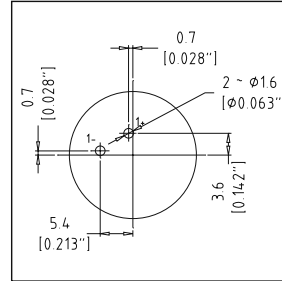

SP-4-MDH
SP-4-MDHT-8
SP-4-MDHT

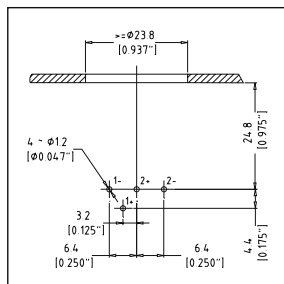

SP-4-MDV
SP-4-MDV-2
SP-4-MDVT-8

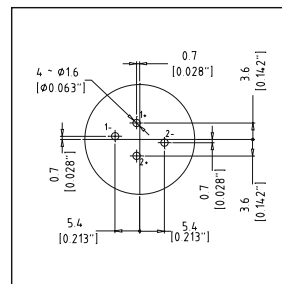

SP SERIES PANEL CUTOUT

SP-2-MD ***
SP-4-MD ***

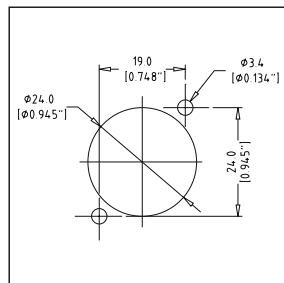

SP-4-MC

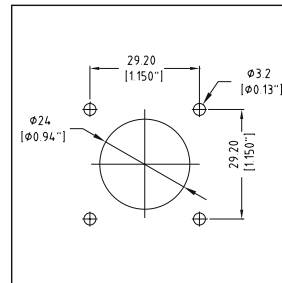

Speaker Connectors

SP Series

PI 1070 ASSEMBLY INSTRUCTIONS

SP SERIES CABLE CONNECTOR



Slide the nut onto the cable



Insert the conductors into the rear of contacts on the insert. Tighten the screws to 0.35Nm (3.0 lb-in) using a T8 Torx screwdriver.

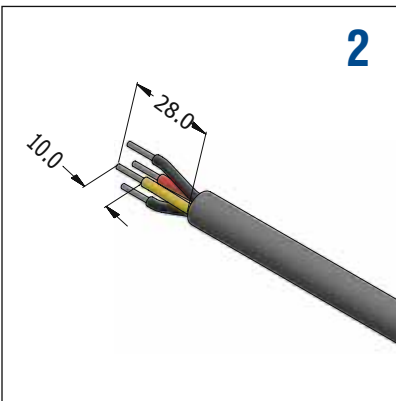

Strip the cable and twist the conductors.



Install the cable clamp, flush to the insert making sure to align the slot as shown in the picture.

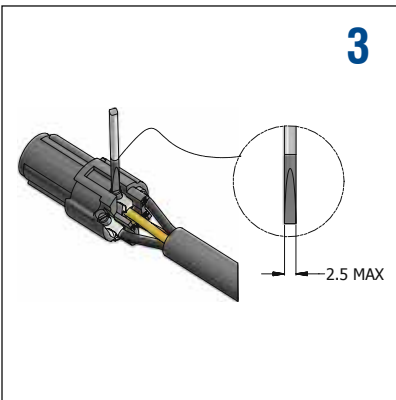

Insert the conductors into the rear of contacts on the insert. Tighten the screws to 0.35Nm (3.0 lb-in) using a flat screwdriver with tip width of 2.5mm max.

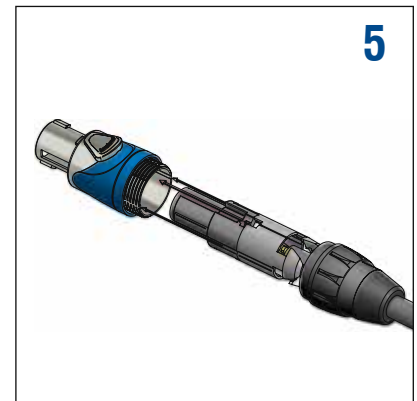

Orientate the insert and cable clamp as shown then push all together into the shell.

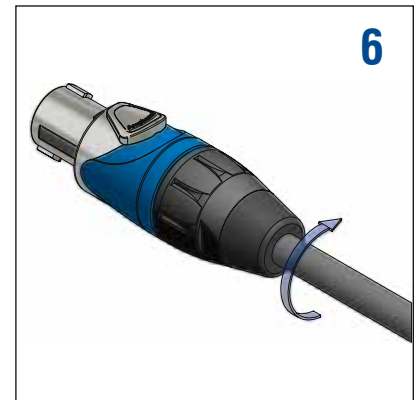

Thread the nut onto the shell to activate the cable clamp and close the connector assembly.

STANDARD DATA SP SERIES CONNECTORS

		VALUE								
GENERAL CHARACTERISTICS	Number of contacts	2 or 4								
	Termination (Chassis)	Printed Circuit Board (PCB) or Solder Tabs 3/16"								
	Termination (Cable Plugs)	Screw or Solder Terminals								
	Flammability	UL94HB								
	Environmental	Complies with EU RoHS 2 Directive 2011/65/EU								
ELECTRICAL CHARACTERISTICS	Service Voltage RMS	133V ¹⁾								
	Test Voltage AC RMS	1500V								
	Current carrying capacity	20A								
	Typical Contact Resistance	≤3mΩ								
	Insulation Resistance (initial)	≥2GΩ								
	Insulation Resistance (after damp heat test)	≥1GΩ								
CLIMATIC CHARACTERISTICS	Protection Class (Mated Condition)	IP20 (IP40)								
	Operating Temperature	-25 °C to +75 °C (-13°F to +167°F)								
MECHANICAL CHARACTERISTICS	Weight** - Chassis Connectors	12g (0.026lb)								
	Weight** - Cable Plug - Thermoplastic - Metal	44g (0.097lb) 65g (0.143lb)								
	Weight** - Cable Plug PG - Thermoplastic - Metal	44g (0.097lb) 65g (0.143lb)								
	Weight** - Cable Plug PG S/Relief - Thermoplastic - Metal	68g (0.150lb) 89g (0.196lb)								
	Typical Cable retention force	200N (Subject to cable material and O.D.)								
	Cable O.D range - Chuck Clamp - PG16 Gland - PG16 Gland S/Relief	<table border="0"> <tr> <td>2 pole</td> <td>4 pole</td> </tr> <tr> <td>5-10mm (0.19" - 0.39")</td> <td>9-14mm (0.35" - 0.55")</td> </tr> <tr> <td>6-12mm (0.23" - 0.47")</td> <td>8-14mm (0.31" - 0.55")</td> </tr> <tr> <td>9-14mm (0.35" - 0.55")</td> <td>9-14mm (0.35" - 0.55")</td> </tr> </table>	2 pole	4 pole	5-10mm (0.19" - 0.39")	9-14mm (0.35" - 0.55")	6-12mm (0.23" - 0.47")	8-14mm (0.31" - 0.55")	9-14mm (0.35" - 0.55")	9-14mm (0.35" - 0.55")
	2 pole	4 pole								
	5-10mm (0.19" - 0.39")	9-14mm (0.35" - 0.55")								
	6-12mm (0.23" - 0.47")	8-14mm (0.31" - 0.55")								
	9-14mm (0.35" - 0.55")	9-14mm (0.35" - 0.55")								
Conductor Size - Screw Terminals - Solder Bucket	1.5mm ² - 4mm ² (AWG16 - AWG12) 1.5mm ² - 6mm ² (AWG16 - AWG10)									
Mechanical Operations	5000 mating cycles									
MATERIALS	Connector Shell / Finish - Cable Plug Thermoplastic - Cable Plug Metal	PA66 GF30 / Black Diecast Zinc Alloy / Nickel or Black								
	Insulators - Chassis - Cable Plugs	PA66 GF20 PA66 GF30								
	Cable Boot / Backshell	Santoprene / PA6 GF 15								
	Cable Clamp (Chuck)	P.O.M								
	Cable Clamp (PG)	Polyemide / EPDM								
	Sleeve	PBT								
	Contact Chassis - Material / Plating Contact Cable Plug - Material / Plating	Phosphor Bronze / Silver Brass / Silver								

Rev 7 - 12/2020

**Approximate weight in grams not including packaging. Please contact us for exact weight for shipping purposes.

¹⁾Not suitable for domestic applications above 50V

Speaker Connectors

EP Series



EP SERIES

The EP Series has set the standard in high performance speaker connectors. Apart from its durability and strength, it offers consistent superior power handling capabilities.



Features:

- Solder Bucket connections.
- Precision machined contacts.
- Diecast Metal Housings
- High current contacts
- Male and female cable and chassis connectors available.

Options: Black Finish Shell

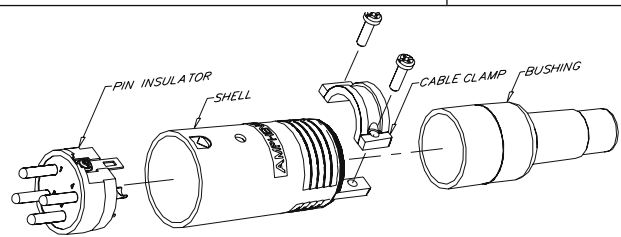

Specifications: Page 83

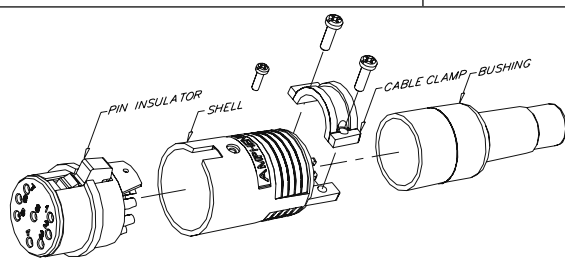
Panel Cutouts: Page 84

PRODUCT - FIGURE	DRAWING	Dimensions in mm (inches)	DESCRIPTION	VARIATIONS	PART NUMBER
 <p>ISO ASSEMBLY OF EP MALE</p>		<p>64.0 [2.521"] 85.5 [3.366"] ø28.9 [ø1.138"]</p>	<p>EP Male cable connector, Machined contacts, Metal Shell</p>	3 pole nickel finish	EP-3-12
				3 pole black finish	EP-3-12B
				4 pole nickel finish	EP-4-12
				4 pole black finish	EP-4-12B
				5 pole nickel finish	EP-5-12
				5 pole black finish	EP-5-12B
				6 pole nickel finish	EP-6-12
				6 pole black finish	EP-6-12B
				8 pole nickel finish	EP-8-12
				8 pole black finish	EP-8-12B
 <p>ISO ASSEMBLY OF EP FEMALE</p>		<p>66.8 [2.63"] 88.0 [3.465"] ø28.8 [ø1.132"]</p>	<p>EP Female cable connector, Machined contacts, Metal Shell</p>	3 pole nickel finish	EP-3-11P
				3 pole black finish	EP-3-11PB
				4 pole nickel finish	EP-4-11P
				4 pole black finish	EP-4-11PB
				5 pole nickel finish	EP-5-11P
				5 pole black finish	EP-5-11PB
				6 pole nickel finish	EP-6-11P
				6 pole black finish	EP-6-11PB
				8 pole nickel finish	EP-8-11P
				8 pole black finish	EP-8-11PB

Speaker Connectors

EP Series

PRODUCT - FIGURE	DRAWING	DESCRIPTION	VARIATIONS	PART NUMBER
		<p>EP Male chassis mount, Round Flange, Machined contacts, Metal Shell</p>	3 pole nickel finish	EP-3-14
			3 pole black finish	EP-3-14B
			4 pole nickel finish	EP-4-14
			4 pole black finish	EP-4-14B
			5 pole nickel finish	EP-5-14
			5 pole black finish	EP-5-14B
			6 pole nickel finish	EP-6-14
			6 pole black finish	EP-6-14B
			8 pole nickel finish	EP-8-14
8 pole black finish	EP-8-14B			
		<p>EP Female chassis mount, Round Flange, Machined contacts, Metal Shell</p>	3 pole nickel finish	EP-3-13P
			3 pole black finish	EP-3-13PB
			4 pole nickel finish	EP-4-13P
			4 pole black finish	EP-4-13PB
			5 pole nickel finish	EP-5-13P
			5 pole black finish	EP-5-13PB
			6 pole nickel finish	EP-6-13P
			6 pole black finish	EP-6-13PB
			8 pole nickel finish	EP-8-13P
8 pole black finish	EP-8-13PB			

Speaker Connectors

AP Series



AP SERIES

The AP Series provides the same power handling performance as the EP Series in a cost effective, yet durable Thermoplastic housing.

Features:

- Solder Bucket connections.
- Precision machined contacts.
- Thermoplastic Housings
- High current contacts
- Male & Female Cable and Chassis connectors available.

Specifications: Page 83

Panel Cutouts: Page 84

PRODUCT - FIGURE	DRAWING	Dimensions in mm (inches)	DESCRIPTION	VARIATIONS	PART NUMBER
			AP Male cable connector, Machined contacts, Thermoplastic Black shell.	4 pole	AP-4-12
				5 pole	AP-5-12
				6 pole	AP-6-12
				8 pole	AP-8-12
			AP Female cable connector, Machined contacts, Thermoplastic Black shell.	4 pole	AP-4-11
				5 pole	AP-5-11
				6 pole	AP-6-11
				8 pole	AP-8-11
			AP Male chassis mount, Rectangular Flange, Machined contacts, Thermoplastic Black shell.	4 pole	AP-4-22
				5 pole	AP-5-22
				6 pole	AP-6-22
				8 pole	AP-8-22
			AP Female chassis mount, Rectangular Flange, Machined contacts, Thermoplastic Black shell.	4 pole	AP-4-21
				5 pole	AP-5-21
				6 pole	AP-6-21
				8 pole	AP-8-21

STANDARD DATA EP/AP

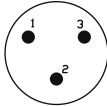
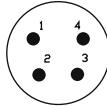
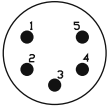
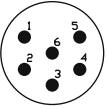
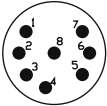
		VALUE				
GENERAL CHARACTERISTICS	Number of contacts	3	4	5	6	8
	Contact Arrangements (Front view of pin insert)					
	Termination	SOLDER				
	Wire Gauge - Stranded wire:	12AWG	12AWG	12AWG	12AWG	14AWG
	Flammability	UL94V-0				
	Environmental	Complies with EU RoHS 2 Directive 2011/65/EU				
ELECTRICAL CHARACTERISTICS	Service Voltage RMS ¹⁾	460V	660V	200V	200V	100V
	Test Voltage AC RMS	2400V	3000V	1600V	1600V	1300V
	Current carrying capacity	20A	20A	20A	20A	15A
	Typical Contact Resistance	≤3mΩ				
	Insulation Resistance	≥1000MΩ				
CLIMATIC CHARACTERISTICS	Protection Class	IP40				
	Operating Temperature	-25 °C to +75 °C (-13°F to +167°F)				
MECHANICAL CHARACTERISTICS	Weight - EP 11 & 12 ²⁾	80g (0.176lb)	84g (0.185lb)	86g (0.189lb)	86g (0.189lb)	86g (0.189lb)
	Weight - EP 13 & 14 ²⁾	48g (0.105lb)	50g (0.110lb)	54g (0.119lb)	54g (0.119lb)	54g (0.119lb)
	Weight - AP 11 & 12 ²⁾	N/A	42g (0.092lb)	44g (0.097lb)	44g (0.097lb)	44g (0.097lb)
	Weight - AP 13, 14, 21 & 22 ²⁾	N/A	26g (0.057lb)	30g (0.066lb)	30g (0.066lb)	28g (0.061lb)
	Typical Cable retention force	22Kg to 44Kg (50lb to 100lb) - Dependant on cable material and diameter				
	Mechanical operations	1000 mating cycles				

¹⁾ Not suitable for domestic applications above 50V

²⁾ Approximate weight only, does not include packaging. Please contact us for exact weight for shipping purposes.

Rev 3 - 03/2013

Speaker Connectors

AP Series

STANDARD DATA EP/AP (CONT'D)

		DETAILS	
MATERIALS	TYPE	AP	EP
	Connector shell	Modified PPE Resin	Diecast Zinc Alloy
	Shell finish	Black	Satin Nickel or Black
	Insulators	UL94V-0 PBT Resin	
	Cable Bushing	Silicon Rubber	UL94 HB Thermoplastic Elastomer
	Male contact Machined - Solder	Brass / Bright Tin	
	Material / Plating		
	Female contact Machined - Solder	Brass / Bright Tin	
	Material / Plating		
CLAMPING CHARACTERISTICS	Cable OD Range	11mm to 17mm (0.43" to 0.67")	9mm to 16mm (0.35" to 0.63")
	Retention Method	Two opposing plastic screws	Metal saddle clamp

Rev 3 - 03/2013

EP/AP SERIES PANEL CUTOUT DATA - FRONT VIEW

EP 13/AP 13/AP 21

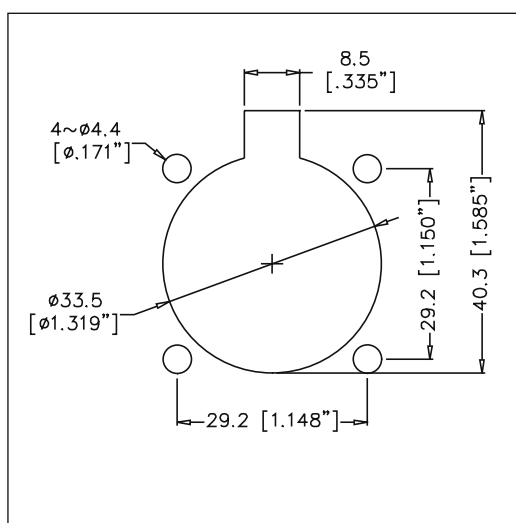

EP 14/AP 14/AP 22

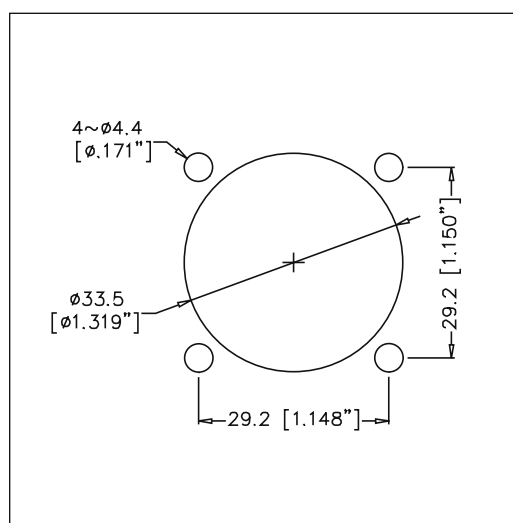



HP SERIES

HP Series connectors are suitable for AC power supply where a latch locking connector is required. They are rated at 25 A / 250 Vac. Connectors are keyed and colour coded for power-in (Blue) and power-out (Grey).

⚡ THE HP SERIES OF CONNECTORS ARE NOT DESIGNED TO BE "HOT PLUGGED" AND SO ARE WITHOUT "BREAKING CAPACITY". IN OTHER WORDS, THE CONNECTORS SHOULD NOT BE CONNECTED OR DISCONNECTED LIVE OR WHEN UNDER LOAD

Features:

- Quick release, vibration resistant latch lock
- 3 pole
- Screw Terminals or Solder Tab 3/16"
- Chuck type cable clamp
- 25A Current rating
- Thermoplastic housing
- Industry standard mating
- UL, cUL recognized components (File no. E339831)



PRODUCT	DRAWING Dimensions in mm (inches)	DESCRIPTION	CONTACT TYPE	SHELL COLOUR	PART NO.
		3 pole, Cable connector, Thermoplastic shell, Blue sleeve, keyed for power-in	Screw	Blue	HP-3-F
		3 pole, Cable connector, Thermoplastic shell, Grey sleeve, keyed for power-out	Screw	Grey	HP-3-FG
		3 pole, Chassis connector, Thermoplastic shell, Blue, keyed for power-in	Solder Tab 3/16"	Blue	HP-3-MD
		3 pole, Chassis connector, Thermoplastic shell, Grey, keyed for power-out	Solder Tab 3/16"	Grey	HP-3-MDG
		3 pole, Chassis connector, Thermoplastic shell, Blue, keyed for power-in, without insulation divider	Solder Tab 3/16"	Blue	HP-3-MDW
		3 pole, Chassis connector, Thermoplastic shell, Grey, keyed for power-out, without insulation divider	Solder Tab 3/16"	Grey	HP-3-MDGW

Power Connectors

HP Series

STANDARD DATA HP SERIES CONNECTORS

		VALUE
GENERAL CHARACTERISTICS	Number of contacts	2 + PE
	Termination	Screw or Solder Tab 3/16"
	Flammability	UL94V-0
	Environmental	Complies with EU RoHS 2 Directive 2011/65/EU
ELECTRICAL CHARACTERISTICS	Rated Operating Voltage	250VAC
	Test Voltage AC RMS	3200V
	Current carrying capacity	25A
	Typical Contact Resistance	≤3mΩ
	Insulation Resistance (initial)	≥2GΩ
	Insulation Resistance (after damp heat test)	≥1GΩ
CLIMATIC CHARACTERISTICS	Protection Class	IP20
	Operating Temperature	-25 °C to +75 °C (-13°F to +167°F)
MECHANICAL CHARACTERISTICS	Weight** - Chassis Connector - Cable Plug	12g (0.026lb) 32g (0.070lb)
	Typical Cable retention force	200N (Subject to cable material and O.D.)
	Cable O.D range - Blue Chuck Clamp - Black Chuck Clamp	5mm - 7.5mm (0.19" - 0.29") 7.5mm - 15mm (0.29" - 0.59")
	Conductor Size - Screw Terminals	2.5mm ² (AWG14)
	MATERIALS	Connector Shell / Finish
Insulators		PA66 GF30
Cable Boot / Backshell		Santoprene / PBT
Cable Clamp (Chuck)		P.O.M
Contact Plug - Material / Plating		Brass / Silver
Contact Chassis - Material / Plating		Phosphor Bronze / Silver

Rev 4 - 08/2016

**Approximate weight in grams not including packaging. Please contact us for exact weight for shipping purposes.



HPT SERIES

HPT Series connectors are suitable for AC power supply where a durable latch locking connector is required. They are rated at 16A, 250 Vac. HPT Series connectors can be connected or disconnected under load and are IP65 rated.



Features:





- 2 + PE contact layout
- Quick release, vibration resistant latch lockable
- High impact UV resistant material
- True Mains Connector with Current Breaking Capacity (CBC)
- 16A current rating (20A USA)
- Industry standard mating interface
- IP65 rated
- Patent Protected*
- UL498 certified
- UL50E enclosure type 4 (when mated or in combination with protective caps)

PRODUCT - FIGURE	DRAWING	Dimensions in mm (inches)	DESCRIPTION	CONTACT TYPE	SHELL COLOUR	PART NUMBER
		79 [3.098"] 29.3 [1.152"] Ø26.5 [Ø1.043"]	3 pole, Outlet Cable connector, Locking, Thermoplastic shell, Screw terminals, Lockable backshell	Screw	Black	HPT-3-F
		79 [3.098"] 29.3 [1.154"] Ø26.5 [Ø1.043"]	3 pole, Outlet Cable connector, Locking, Thermoplastic shell, Screw terminals	Screw	Black	HPT-3-FJ
		77 [3.043"] 32.0 [1.261"] Ø26.5 [Ø1.043"]	3 pole, Inlet Cable connector, Locking, Thermoplastic shell, Screw terminals, Lockable backshell	Screw	Black	HPT-3-M
		77 [3.043"] 32.0 [1.231"] Ø26.5 [Ø1.043"]	3 pole, Inlet Cable connector, Locking, Thermoplastic shell, Screw terminals	Screw	Black	HPT-3-MJ
		19.0 [0.748"] Ø3.2 [Ø0.126"] 31.0 [1.220"] 26.0 [1.023"] 24.4 [0.961"] 23.7 [0.933"] 10.5 [0.413"] 4.5 [0.177"] 2.5 [0.098"]	3 pole, Chassis Inlet connector, Thermoplastic shell, ¼" flat tab terminals	Tab ¼"	Black/ Yellow	HPT-3-MD
		19.0 [0.748"] Ø3.2 [Ø0.126"] 31.0 [1.220"] 26.0 [1.024"] 24.4 [0.961"] 23.7 [0.933"] 10.5 [0.413"] 4.5 [0.177"] 2.5 [0.098"]	3 pole, Chassis Inlet connector, Thermoplastic shell, without insulation divider, ¼" flat tab terminals	Tab ¼"	Black/ Yellow	HPT-3-MDW
		Ø3.2 [Ø0.126"] 24.4 [0.961"] 35.4 [1.394"] 24.4 [0.961"] 24.4 [0.961"] 10.5 [0.413"] 4.5 [0.177"] 5.7 [0.224"]	3 pole, Chassis Outlet connector, Thermoplastic shell, ¼" flat tab terminals	Tab ¼"	Black/ Yellow	HPT-3-FD
		Ø3.2 [Ø0.126"] 24.4 [0.961"] 35.4 [1.394"] 24.4 [0.961"] 24.4 [0.961"] 10.5 [0.413"] 4.5 [0.177"] 5.7 [0.224"]	3 pole, Chassis Outlet connector, Thermoplastic shell, without insulation divider, ¼" flat tab terminals	Tab ¼"	Black/ Yellow	HPT-3-FDW
		50.0 [1.969"] Ø3.4 [Ø0.134"] 26.2 [1.031"] 2.5 [0.098"] 35.4 [1.394"] 61.0 [2.402"] 24.4 [0.961"] 4.5 [0.177"] 5.7 [0.224"]	3 pole, Chassis Inlet-Outlet combination, Thermoplastic shell, ¼" flat tab terminals	Tab ¼"	Black/ Yellow	HPT-3-CC

*Patent Protected refer to <http://www.amphenolaudio.com/patents/>

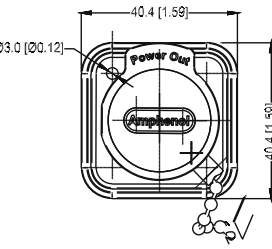
Power Connectors

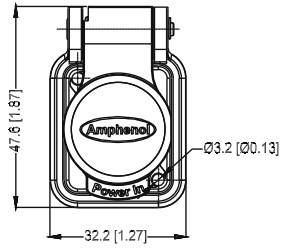
HPT Series

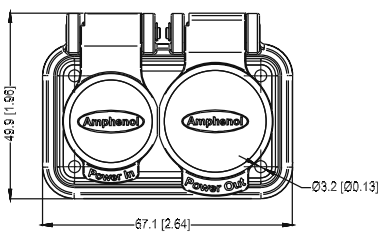
PRODUCT - FIGURE	DRAWING	DESCRIPTION	COLOUR	PART NUMBER
		Protective sealing cap with stainless steel lanyard to suit HPT-3-MD / HPT-3-MDW	Black	HPT-CAPM
		Protective sealing cap with stainless steel lanyard to suit HPT-3-FD / HPT-3-FDW	Black	HPT-CAPF
		Protective sealing cap with stainless steel lanyard to suit HPT-3-CC	Black	HPT-CAPD
		Protective Self-closing sealing cap with stainless steel spring to suit HPT-3-MD / HPT-3-MDW	Black	HPT-CAPSM
		Protective Self-closing sealing cap with stainless steel spring to suit HPT-3-FD / HPT-3-FDW	Black	HPT-CAPSF
		Protective Self-closing sealing cap with stainless steel spring to suit HPT-3-CC	Black	HPT-CAPSD
		Cable connector backshell lock release tool	Black	HPT-RT

STANDARD DATA HPT SERIES CONNECTORS

		VALUE
GENERAL CHARACTERISTICS	Number of contacts	2 + PE
	Termination - Cable Connector - Chassis Mount	2mm Hex key screw terminal Flat Tab 1/4"
	Flammability	UL94V-0
	Environmental	Complies with EU RoHS 2 Directive 2011/65/EU
ELECTRICAL CHARACTERISTICS	Rated Operating Voltage	250VAC
	Test Voltage AC RMS	1500V
	Current carrying capacity	16A (20A USA)
	Typical Contact Resistance	≤2mΩ
	Insulation Resistance (initial)	≥2GΩ
	Insulation Resistance (after damp heat test)	≥0.1GΩ
	Breaking Cycles	5000
CLIMATIC CHARACTERISTICS	Protection Class	IP65, UL50E enclosure type 4 (in mated or in combination with protective caps)
	Operating Temperature	-25 °C to +80 °C (-13°F to +176°F)
MECHANICAL CHARACTERISTICS	Weight** - Chassis Connector - Cable Plug	15g (0.033lb) / 25g (0.055lb) 40g (0.088lb)
	Typical Cable retention force	Subject to cable material and O.D.
	Cable O.D range	6.0 -12.0 mm with lockable backshell 7.5 -16.0 mm with non-lockable backshell
	Conductor Size - Screw Terminals	2.5mm ² (AWG12)
	Mating Cycles	5000
MATERIALS	Connector Shell / Finish	PA66 GF30 / Black
	Insulators	PA66 GF30
	Cable Boot / Backshell	Neoprene / PBT
	Contact Plug - Material / Plating	Copper Alloy / Silver
	Contact Chassis - Material / Plating	Copper Alloy / Silver
	Protective Caps - Base - Overmolded Cap - Chain	Santoprene, UV resistant PA66 & Santoprene, UV resistance Stainless Steel SS304
	Protective Caps (Self closing) - Base - Overmolded Cap - Gasket - Spring	Polycarbonate, UV resistant Polycarbonate & Santoprene, UV resistant Silicone Rubber Stainless Steel SS304

Rev 5 - 03/2023

**Approximate weight in grams not including packaging. Please contact us for exact weight for shipping purposes.

Data Connectors

Amphe-Dante Adapters



Amphe-Dante feature high-quality digital-to-analogue converters, and support a range of sample rates and bit depths. They can provide a hardware master clock for a Dante network. As with other Dante products, the freely available Dante Controller software application is used to automatically discover and configure Amphe-Dante devices connected to the Dante network. Device names, channel labels, signal routing and other parameters (for example, sample rate and latency) can be configured via the network using Dante Controller. A variety of network and clock synchronisation diagnostic tools are also available in Dante Controller.

Amphe-Dante products use Power over Ethernet (PoE). Power can be provided through the Ethernet cable from a PoE-capable network switch, or from a separate PoE injector.

Available Software Options (required)

Dante Controller

Dante Controller is a free software application that enables you to route audio and configure devices on a Dante network. As well as automatic device discovery, one-click signal routing and user-editable device and channel labels, Dante Controller provides essential device status information and powerful real-time network monitoring, including device-level latency and clock stability stats, multicast bandwidth usage, and customized event logging, enabling you to quickly identify and resolve any potential network issues.

Dante Via

Dante Via is powerful and easy-to-use software that delivers unprecedented routing of computer-based audio, allowing a wide range of applications and devices to be networked and interconnected, easily and inexpensively. Dante Via network-enables locally-connected USB and Firewire devices, and a huge range of software applications, allowing you to route computer-based audio across an existing Dante network, and create standalone Dante networks without dedicated Dante hardware.

Dante Virtual Soundcard

Dante Virtual Soundcard turns your computer into a Dante-powered workstation, seamlessly integrating your PC or Mac with Dante audio devices on your network. You can instantly connect to a Dante network to record, process and playout using any audio application and any combination of Dante-enabled devices.

AMPHE-DANTE ADAPTERS

Amphe-Dante are Dante™ audio to analogue audio adapters, available for Input, Output, AES3 and USB applications. Featuring premium quality Amphenol AX series XLR and RJ45 connectors in a robust molded housing.

Amphe-Dante products enable simple connection of analogue equipment to a Dante network and can receive and transmit audio channels from a Dante network and provide studio-quality, low-latency audio via XLR connectors to and from analogue audio equipment.

Dante Controller

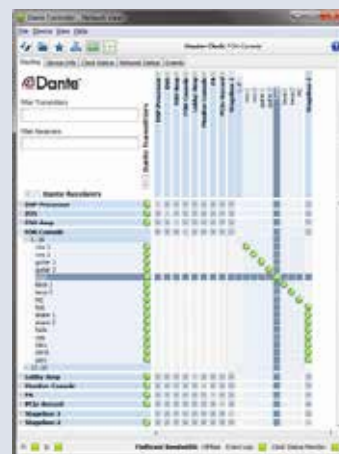

All software can be purchased and downloaded at amphenolaudio.com/products/dante

Data Connectors

Amphe-Dante Adapters



Features:

- Dante™ to analogue XLR output adapters
- Line level analogue input to Dante™ audio output adapters
- Dante™ AES3 2 channel input/output adapters
- Dante™ USB input/output adapters
- One channel or Two channel analogue input or output
- Durable overmolded housing
- Resilient cable strain relief
- Shielded RJ45 metal connectors with integrated LED's
- Premium AX Series XLR connectors

PRODUCT	DRAWING Dimensions in mm (inches)	DESCRIPTION	PART NO.
ANALOGUE OUTPUT			
		Analogue Output - 1 channel, RJ45 input to XLR output, Durable overmolded housing 	RJD1112-0050
		Analogue Output - 2 channel, RJ45 input to XLR output, Durable overmolded housing 	RJD1212-0050
ANALOGUE INPUT			
		Analogue line level Input - 1 channel XLR input to RJ45 output, Durable overmolded housing 	RJD2103-0050
		Analogue line level Input - 2 channel XLR input to RJ45 output, Durable overmolded housing 	RJD2203-0050
AES3			
		AES3 Input / Output - 2 channel XLR I/O to RJ45 I/O, Durable overmolded housing 	RJD32A3-0050
USB			
		USB Input / Output - 2 channel USB I/O to RJ45 I/O Durable overmolded housing 	RJD32U1-0050

Data Connectors

Amphe-Dante Adapters

SPECIFICATIONS

		ANALOG INPUT 1CH	ANALOG INPUT 2CH	ANALOG OUT-PUT 1CH	ANALOG OUT-PUT 2CH	AES3 I/O 2 IN 2 OUT	USB I/O 2 IN 2 OUT	
GENERAL	Connectors	1 XLR-F	2 XLR-F	RJ45	RJ45	RJ45	RJ45	
		RJ45	RJ45	1 XLR-M	2 XLR-M	1 XLR-M, 1 XLR-F	USB 2.0 Type A	
ELECTRICAL	Power Consumption	< 2 Watt						
	Power over Ethernet (Required)	Class 1 IEEE 802.3af POE PD compliant						PoE or USB
ANALOG / DIGITAL AUDIO	Max Signal Level (Balanced)	+24dBu / +4dBu / 0dBu / 0dBV / -10dBV		+18dBu / +4dBu / 0dBu / 0dBV / -10dBV		-	-	
	Impedance	20k Ohm balanced 10k Ohm unbalanced		150 Ohm balanced 75 Ohm unbalanced		110 Ohm balanced	-	
	Frequency Response	20Hz to 20 kHz (+/-0.5db)		20Hz to 20 kHz (+/-0.5db)		-	-	
	Dynamic Range	> 100dB		> 100dB		-	-	
	Signal to Noise	> 100dB		> 100dB		> 135dB	-	
	Total Harmonic Distortion	< 0.01% at +4dBu		< 0.01% at +4dBu		-	-	
	Channel Separation	N/A	> 100 dB	N/A	> 100 dB		-	
	Channel Matching	N/A	< 0.25 dB	N/A	< 0.25 dB		-	
DANTE® AUDIO	Asynchronous Sample Rate Conversion	-		-		Yes	-	
	Sample Rate	44.1 kHz, 48 kHz (default), and 96 kHz						48 kHz
	Bit Depth	24 bits						
	Network Speed	100 Mbps						
	Network Interface	Latency from 1ms						
	Network Transport	Dante Audio over IP, AES67 RTP						
CLIMATIC	Protection Class	IP40						
	Operating Temperature	-5°C to +60°C (23°F to +140°F)						
MECHANICAL	Insertion and Withdrawal Force	≥10N - ≤35N						
	Weight	136g (0.299lb)	192g (0.423lb)	136g (0.299lb)	192g (0.423lb)	192g (0.423lb)	110g (0.243lb)	
MATERIALS	Housing	PVC 60P Black						

Rev 4 - 08/2018

LED STATUS

LEFT LED RIGHT LED



FUNCTION	LEFT LED	RIGHT LED	COMMENT
Off	OFF	OFF	No Power
Device is booting	Solid GREEN	Solid RED	
Slave with sync	Blinking GREEN	Solid GREEN	Normal operation
Clock Master	Blinking GREEN	Blinking GREEN	Normal operation
Any runtime error	Blinking GREEN	Blinking RED	Normal operation
Identify	Alternating RED and GREEN	Alternating RED and GREEN	Blinking for 6 seconds (cycle every 0.5 seconds)
Failsafe (bootloader)	Blinking RED	Blinking RED	Failsafe, Corrupt Capability (red in DC)
Upgrade (bootloader)	Blinking ORANGE	Blinking ORANGE	Device is upgrading



XLRnet Connectors

XLRnet was designed in conjunction with the Amphenol Data / Telecom product group of Amphenol Canada Corp., a subsidiary of Amphenol Corporation. Utilising our combined expertise and knowledge of the professional audio and high-speed data markets we are proud to offer the XLRnet series. Featuring Class D (10/100 BASE-T), CAT5E (1000 BASE-T) or CAT6 (10GBASE-T) ethernet performance in A, B or D shell housings with integrated LED's or light pipes and complete shielding options we have your high-speed data requirements covered.

Features

- Class D (10/100 BASE-T), CAT5E (1000 BASE-T) or CAT6 (10GBASE-T) ethernet performance
- A, B or D type chassis housings
- IDC or IDC 110 punch down terminals
- RJ45 feedthrough panel connectors
- Shielded or non-shielded
- LED indicators in a variety of colours.
- Light pipes
- Compact design
- Cable plug housings
- Quick and simple installation

Options

- Horizontal or Vertical PCB contacts
- Bulk Packaging
- LED colour - Red, Green, Yellow or Blue combinations
- Light Pipes

Ordering Codes

We have listed the more common ordering codes in each section. Please contact us if you need any further assistance.

Simple steps to guide you in using this catalogue

- 1) Identify the product group listed in Contents on page 1 and go directly to that page number.
- 2) Each product group cover page then details information and options available.
- 3) Refer to the product detail pages and identify the product you require pictorially.
- 4) Read the product description column for the products standard features.
- 5) Use variations column to determine your choice.
- 6) Identify part number.
- 7) In the event the particular option you require is not listed please refer to the part number breakdown page at the end of each section.
- 8) Please contact us directly if you have any further problems.

Data Connectors

XLRnet Series Cable Connector



XLRNET SERIES CABLE CONNECTOR

Features/Benefits:







- XLR RJ45 Cable plug housing.
- Designed for pre-assembled RJ45 cables.
- Quick and simple installation.
- Cost effective method for harsh environments.
- No cabling in field required.
- No tools required for installation.
- Available in Nickel or Black housings.
- Coloured boots / Backshells

Specifications: Page 95

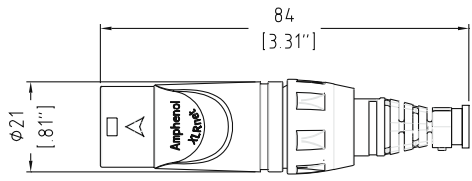
Part Number Breakdown : Page 95

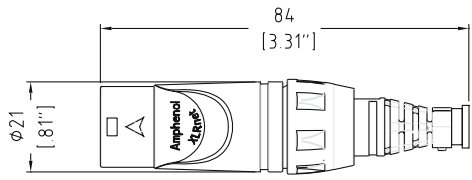
Assembly Instructions: Page 98

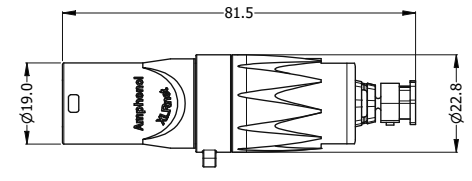
NOTE*RJ45 preassembled cable sold separately and is not included with the XLRnet connector.

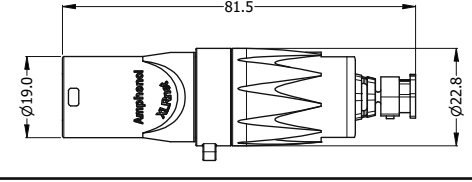
PRODUCT - FIGURE	DRAWING	Dimensions in mm (inches)	DESCRIPTION	VARIATIONS	PART NUMBER
		84 [3.31"] Ø21 [.81"]	XLRnet, XLR cable plug housing to suit preassembled RJ45 cables, Nickel Finish	Standard Bulk Pack	RJX8M RJX8M BULK
		84 [3.31"] Ø21 [.81"]	XLRnet, XLR cable plug housing to suit preassembled RJ45 cables, Black Finish	Standard Bulk Pack	RJX8MB RJX8MB BULK
		81.5 Ø19.0 Ø22.8	XLRnet, XLR cable plug housing to suit preassembled RJ45 cables, Nickel Finish	Standard Bulk Pack	RJXX8M RJXX8M BULK
		81.5 Ø19.0 Ø22.8	XLRnet, XLR cable plug housing to suit preassembled RJ45 cables, Black Finish	Standard Bulk Pack	RJXX8MB RJXX8MB BULK

ISO VIEW OF RJX8M

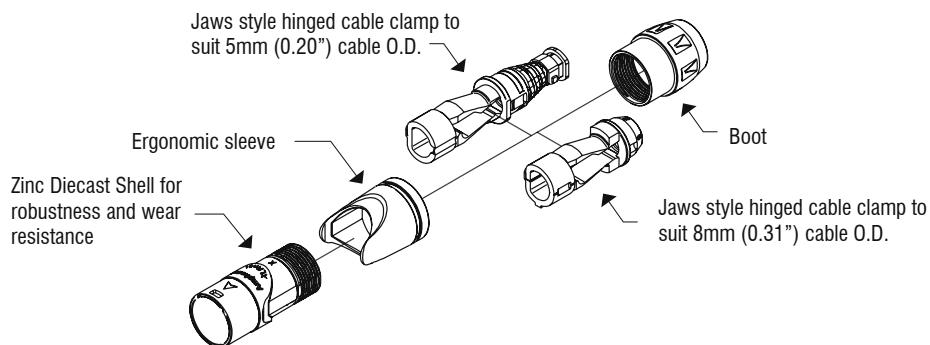

PART NUMBER BREAKDOWN

XLRnet SERIES

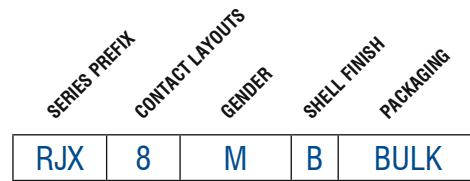

E. G. **RJX8MB BULK**
RJX (Series Prefix), **8** contacts, **M** (Cable Connector), **B** (Black Finish),
Bulk Packaged

SERIES PREFIX	RJX = Series Prefix RJXX = Series Prefix
CONTACT LAYOUT	8 = RJ45 Cable Housing
GENDER	M = Male Cable Plug
SHELL FINISH	Blank = Nickel Plated Finish B = Metal - Black Finish
PACKAGING	Blank = Individual Bags BULK = Bulk Packed

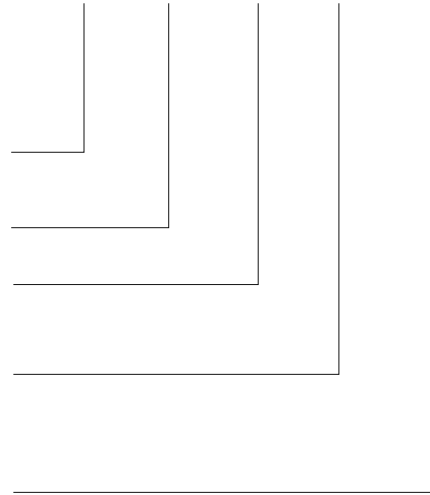

STANDARD DATA XLRnet SERIES

		VALUE
GENERAL CHARACTERISTICS	Termination	Preassembled RJ45 Cable (Not supplied)
	Environmental	Complies with EU RoHS 2 Directive 2011/65/EU
CLIMATIC CHARACTERISTICS	Protection Class	IP40
	Operating Temperature	-25°C to +75°C (-13°F to +167°F)
MECHANICAL CHARACTERISTICS	Insertion and Withdrawal force	≥ 10N - ≤ 20N
	Weight ²⁾	26g (0.057lb)
	Cable O.D. range	5 or 8mm (0.20" or 0.31")
	Mechanical Operations	1000 mating cycles
MATERIALS	Connector shell - Metal Shell finish	Diecast Zinc Alloy Satin nickel or Black
	Boot / Backshell	UL94V-0 Noryl N190 / Valox (RJX8M / RJX8MB) UL94 V-0 PBT-RG151(f1) (RJXX8M / RJXX8MB)
	Finish	Black
	Cable clamp	PA6
	Sleeve	Valox

²⁾ Approximate weight only, does not include packaging. Please contact us for exact weight for shipping purposes.

Rev 1 - 03/2013

Data Connectors

XLRnet Series Cable Connector



XLRNET SERIES CABLE CONNECTOR

Features/Benefits:

- XLR RJ45 Cable plug housing.
- Designed for pre-assembled RJ45 cables.
- Quick and simple installation.
- Cost effective method for harsh environments.
- No cabling in field required.
- No tools required for installation.
- Available in Nickel or Black housings.
- Coloured boots / Backshells

Specifications: Page 95

Part Number Breakdown : Page 95

Assembly Instructions: Page 98

NOTE*RJ45 preassembled cable sold separately and is not included with the XLRnet connector.

PRODUCT - FIGURE	DRAWING	Dimensions in mm (inches)	DESCRIPTION	VARIATIONS	PART NUMBER
		84 [3.31\"/>	XLRnet, XLR cable plug housing to suit pre-assembled RJ45 cables, Nickel Finish	Standard	RJX8M
				Bulk Pack	RJX8M BULK
		84 [3.31\"/>	XLRnet, XLR cable plug housing to suit pre-assembled RJ45 cables, Black Finish	Standard	RJX8MB
				Bulk Pack	RJX8MB BULK

ISO VIEW OF RJX8M

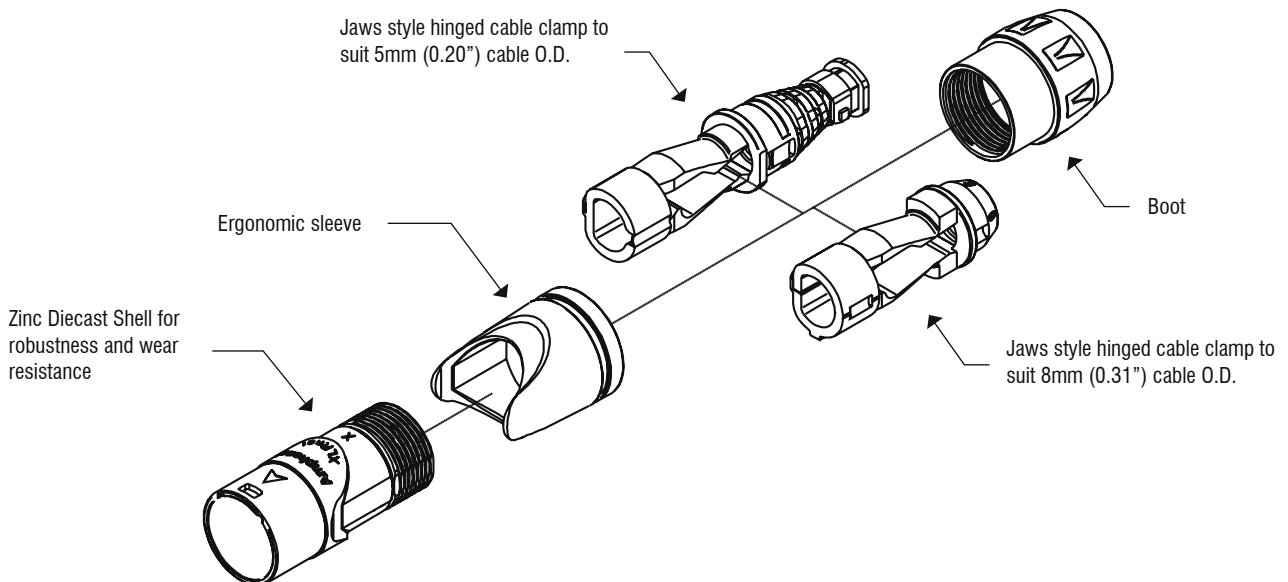

PART NUMBER BREAKDOWN

XLRnet SERIES

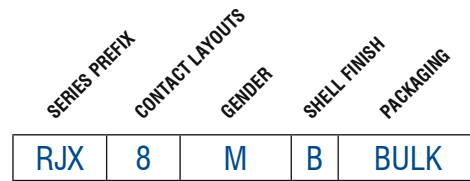

E. G. **RJX8MB BULK**
RJX (Series Prefix), **8** contacts, **M** (Cable Connector), **B** (Black Finish),
Bulk Packaged

SERIES PREFIX	RJX	=	Series Prefix
CONTACT LAYOUT	8	=	RJ45 Cable Housing
GENDER	M	=	Male Cable Plug
SHELL FINISH	Blank	=	Nickel Plated Finish
	B	=	Metal - Black Finish
PACKAGING	Blank	=	Individual Bags
	BULK	=	Bulk Packed

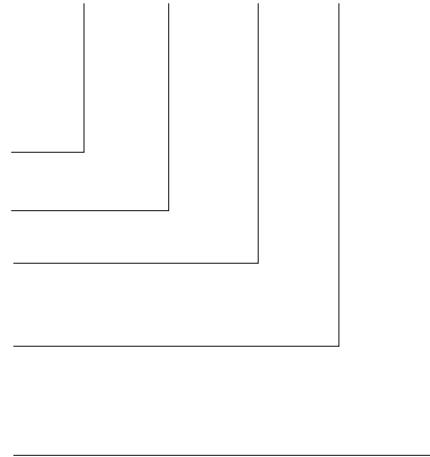

STANDARD DATA XLRnet SERIES

		VALUE
GENERAL CHARACTERISTICS	Termination	Preassembled RJ45 Cable (Not supplied)
	Environmental	Complies with EU RoHS 2 Directive 2011/65/EU
CLIMATIC CHARACTERISTICS	Protection Class	IP40
	Operating Temperature	-25°C to +75°C (-13°F to -167°F)
MECHANICAL CHARACTERISTICS	Insertion and Withdrawal force	≥ 10N - ≤ 20N
	Weight ²⁾	26g (0.057lb)
	Cable O.D. range	5 or 8mm (0.20" or 0.31")
	Mechanical Operations	1000 mating cycles
MATERIALS	Connector shell - Metal Shell finish	Diecast Zinc Alloy Satin nickel or Black
	Boot / Backshell Finish	UL94V-0 Noryl N190 / Valox Black
	Cable clamp	PA6
	Sleeve	Valox

²⁾ Approximate weight only, does not include packaging. Please contact us for exact weight for shipping purposes.

Rev 1 - 03/2013

Data Connectors

XLRnet Series Cable Connector

XLRnet SERIES CABLE ASSEMBLY INSTRUCTIONS

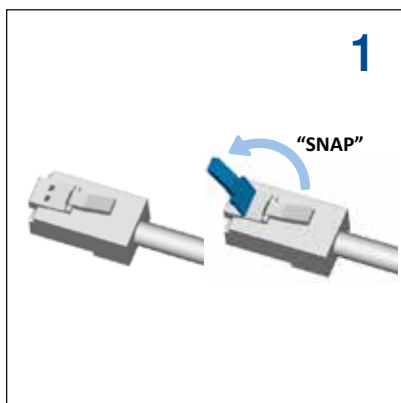

Snap or cut off release tab of the RJ45 plug.

⚠ Failure to remove the RJ45's Release Tab will make the XLRnet assembly permanently latching. The XLRnet series has an independent panel side latching system.

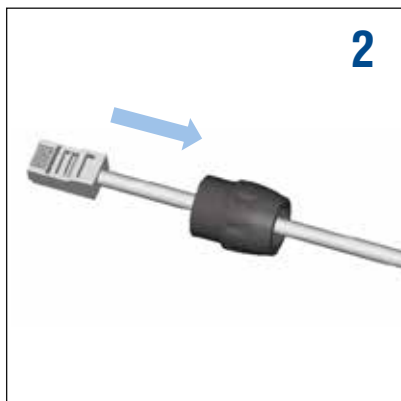

Slide the nut (backshell) onto the cable.

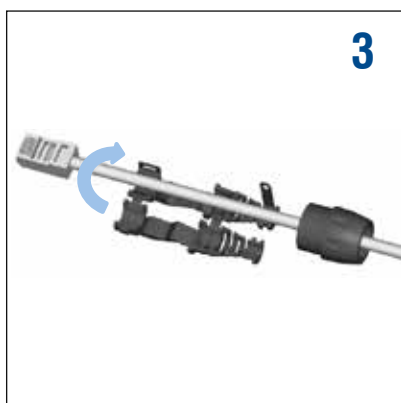

Install the cable clamp-boot.



Close clamp-boot, fasten the two tabs together to lock.



Push clamp-boot & cable together into the shell

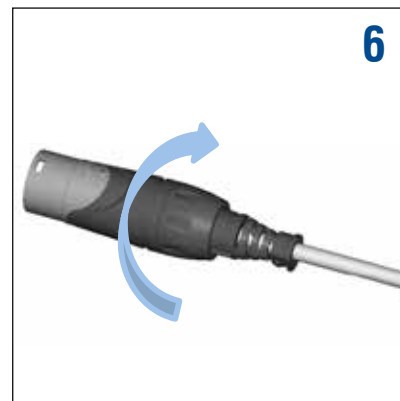

Thread the nut (backshell) onto the shell (torque 0.8Nm-1.2Nm) to close the connector assembly.



XLrnet Series A & B Type Chassis Receptacles

Features:

- RJ45 Class D (10/100 BASE-T), CAT5E (1000 BASE-T) or CAT6 (10GBASE-T) Ethernet performance
- A or B type chassis housings
- Shielded or non-shielded
- LED indicators in a variety of colours
- Light pipes
- Horizontal or Vertical PCB
- Mates with XLrnet cable plugs or standard RJ45 plug.

Part Number Breakdown: Page 102

Specifications: Page 109

PCB Footprints: Page 103











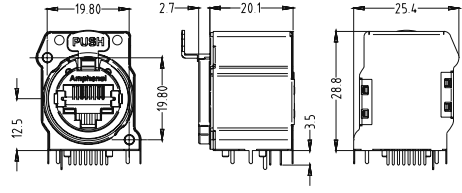

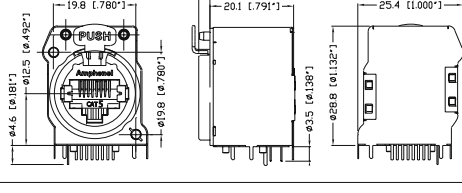
Recommended Fastener: Page 155

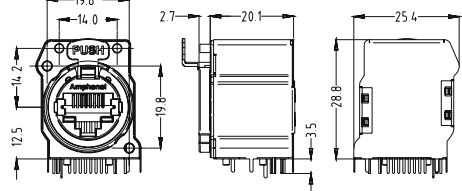
PRODUCT - FIGURE	DRAWING	Dimensions in mm (inches)	DESCRIPTION	TYPE	LED* LHS/RHS	PART NUMBER	
			XLrnet chassis, A type, Horizontal PCB	Class D	-	-	RJX8FA3HB
				CAT5E			RJX8FA5HB
				CAT6			RJX8FA6HB
			XLrnet chassis B type, Horizontal PCB	Class D	-	-	RJX8FB3HB
				CAT5E			RJX8FB5HB
				CAT6			RJX8FB6HB
			XLrnet chassis, B type, Light pipes, Horizontal PCB, Bulk packed	CAT5E	-	-	RJX8FB5HLPB
				CAT6	-	-	RJX8FB6HLPB
			XLrnet chassis, B type, LEDs, Horizontal PCB, Bulk packed	CAT5E	R	G	RJX8FB5HRGB
					R	Y	RJX8FB5HRYB
					R	R	RJX8FB5HRRB
					G	R	RJX8FB5HGRB
					G	Y	RJX8FB5HGYB
				CAT6	U	U	RJX8FB5HUUB
					R	G	RJX8FB6HRGB
					R	Y	RJX8FB6HRYB
					R	R	RJX8FB6HRRB
					G	R	RJX8FB6HGRB
G	Y	RJX8FB6HGYB					
U	U	RJX8FB6HUUB					

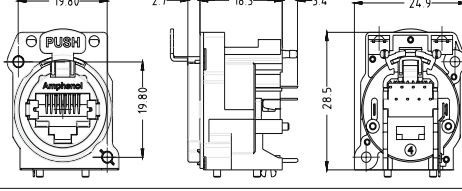
*Note: LED colours are denoted left to right from the panel side front view. Refer page 108 R = Red, G = Green, Y = Yellow, U = Blue

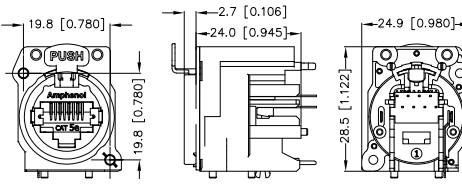
Data Connectors

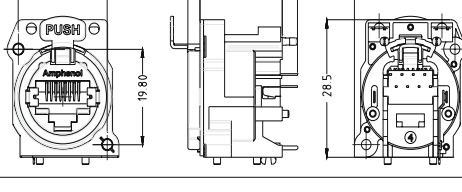
XLrnet Series A & B Type Chassis Receptacles

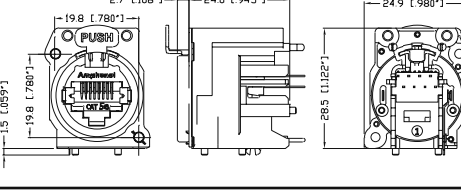
PRODUCT - FIGURE	DRAWING	Dimensions in mm (inches)	DESCRIPTION	TYPE	LED* LHS/RHS	PART NUMBER
		19.80, 2.7, 20.1, 25.4, 12.5, 19.80, 28.8, 3.5	XLRnet chassis, B type, Shielded Hood, Horizontal PCB, Bulk packed	Class D CAT5E CAT6	- - -	RJX8FB3HEB RJX8FB5HEB RJX8FB6HEB
		19.8 [0.780"], 2.7 [0.106"], 20.1 [0.791"], 25.4 [1.000"], 12.5 [0.492"], 19.8 [0.780"], 28.8 [1.132"], 3.5 [0.138"]	XLRnet chassis, B type, Shielded Hood, Light pipes, Horizontal PCB, Bulk packed	CAT5E CAT6	- -	RJX8FB5HLPB RJX8FB6HLPB
		19.8, 14.0, 2.7, 20.1, 25.4, 12.5, 16.2, 19.8, 28.8, 3.5	XLRnet chassis, B type, Shielded Hood, LEDs, Horizontal PCB, Bulk packed	CAT5E CAT6	R G R Y R R G R G Y U U R G R Y R R G R G Y U U	RJX8FB5HRGEB RJX8FB5HRYEB RJX8FB5HRRRB RJX8FB5HGREB RJX8FB5HGWEB RJX8FB5HUUEB RJX8FB6HRGEB RJX8FB6HRYEB RJX8FB6HRRRB RJX8FB6HGREB RJX8FB6HGWEB RJX8FB6HUUEB
		19.80, 2.7, 18.3, 3.4, 24.9, 19.80, 28.5	XLRnet chassis, A type, Vertical PCB - 18.3mm, Bulk packed	Class D CAT5E CAT6	- - -	RJX8FA3VB RJX8FA5VB RJX8FA6VB
		19.8 [0.780], 2.7 [0.106], 24.0 [0.945], 24.9 [0.980], 19.8 [0.780], 28.5 [1.122]	XLRnet chassis, A type, Vertical PCB - 24mm, Bulk packed	CAT5E CAT6	- -	RJX8FA5V2B RJX8FA6V2B
		19.80, 2.7, 18.3, 3.4, 24.9, 19.80, 28.5	XLRnet chassis, B Type, Vertical PCB - 18.3mm, Bulk packed	Class D CAT5E CAT6	- - -	RJX8FB3VB RJX8FB5VB RJX8FB6VB
		2.7 [0.106"], 24.0 [0.945"], 24.9 [0.980"], 19.8 [0.780"], 19.8 [0.780"], 28.5 [1.122"], 1.5 [0.059"]	XLRnet chassis, B type, Vertical PCB - 24mm, Bulk packed	CAT5E CAT6	- -	RJX8FB5V2B RJX8FB6V2B

*Note: LED colours are denoted by left to right from the panel side front view. Refer page 108 R = Red, G = Green, Y = Yellow, U = Blue

Data Connectors

XLRnet Series A & B Type Chassis Receptacles

PRODUCT - FIGURE	DRAWING	Dimensions in mm (inches)	DESCRIPTION	TYPE	LED* LHS/RHS	PART NUMBER
			XL Rnet chassis, B type, Light pipes, Vertical PCB - 24mm, Bulk packed	CAT5E	- -	RJX8FB5V2LPB
				CAT6	- -	RJX8FB6V2LPB
			XL Rnet chassis, B type, LEDs, Vertical PCB, Bulk packed	CAT5E	R G	RJX8FB5VRGB
					R Y	RJX8FB5VRYB
					R R	RJX8FB5VRRB
					G R	RJX8FB5VGRB
					G Y	RJX8FB5VGYB
				CAT6	R G	RJX8FB6VRGB
					R Y	RJX8FB6VRYB
					R R	RJX8FB6VRRB
					G R	RJX8FB6VGRB
					G Y	RJX8FB6VGYB
			XL Rnet chassis, B type, Shielded Hood, Vertical PCB, - 18.3mm, Bulk packed	Class D	- -	RJX8FB3VEB
				CAT5E	- -	RJX8FB5VEB
				CAT6	- -	RJX8FB6VEB
			XL Rnet chassis, B type, Shielded Hood, Vertical PCB - 24mm, Bulk packed	CAT5E	- -	RJX8FB5V2EB
				CAT6	- -	RJX8FB6V2EB
			XL Rnet chassis, B type, Shielded Hood, Light pipes, Vertical PCB - 24mm, Bulk packed	CAT5E	- -	RJX8FB5V2LPB
				CAT6	- -	RJX8FB6V2LPB
			XL Rnet chassis, B type, Shielded Hood, LEDs, Vertical PCB, - 18.3mm, Bulk packed	CAT5E	R G	RJX8FB5VRGEB
					R Y	RJX8FB5VRYEB
					R R	RJX8FB5VRRB
					G R	RJX8FB5VGRB
					G Y	RJX8FB5VGYEB
				CAT6	R G	RJX8FB6VRGEB
					R Y	RJX8FB6VRYEB
					R R	RJX8FB6VRRB
					G R	RJX8FB6VGRB
					G Y	RJX8FB6VGYEB
CAT6	R G	RJX8FB6VUUEB				
	R Y	RJX8FB6VRYEB				
	R R	RJX8FB6VRRB				
	G R	RJX8FB6VGRB				
	G Y	RJX8FB6VGYEB				
CAT6	R G	RJX8FB6VUUEB				
	R Y	RJX8FB6VRYEB				
	R R	RJX8FB6VRRB				
	G R	RJX8FB6VGRB				
	G Y	RJX8FB6VGYEB				

*Note: LED colours are denoted left to right from the panel side front view. Refer page 108 R = Red, G = Green, Y = Yellow, U = Blue

Data Connectors

XLRnet Series A & B Type Chassis Receptacles

PART NUMBER BREAKDOWN

XLRnet A and B Type Printed Circuit Board Connectors

SERIES PREFIX
CONTACT LAYOUTS
GENDER
SHELL SERIES
TRANSMISSION CLASS
TERMINATION
LOCKING MECHANISM
LED COLOURS
EMI / RFI HOOD
PACKAGING

E. G. **RJX8FB5HLRREB**
RJX (Series Prefix), **8** (Contacts), **F** Female **B** type, **5** Cat5E **H**orizontal, **L**atchless,
Red - Red LEDs, **E**MI / RFI Hood, **B**ulk Packaged.

RJX **8** **F** **B** **5** **H** **L** **RR** **E** **B**

SERIES PREFIX	RJX =	Series Prefix
CONTACT LAYOUT	8 =	RJ45 type
GENDER	F =	Receptacle housing
SHELL SERIES	A = B =	A Type B Type
TRANSMISSION CLASS	3 = 5 = 6 =	Class D CAT 5e CAT 6
TERMINATION	H = V = V2 =	Horizontal Printed Circuit Board Vertical Printed Circuit Board Vertical PCB 24mm
LOCKING MECHANISM	Blank = P =	Latching Push lever supplied separately for customer installation (Contact factory for detailed fitting instructions)
LED COLOUR SEQUENCE*	Blank = RG = RY = RR = GR = GY = GG = YR = YY = YG = UU = LP =	No LEDs Red / Green Red / Yellow Red / Red Green / Red Green / Yellow Green / Green Yellow / Red Yellow / Yellow Yellow / Green Blue / Blue Light Pipes**
EMI / RFI SHIELDING HOOD	Blank = E =	No shield hood EMI / RFI shield hood
PACKAGING	Blank = B =	Individual Bulk packed

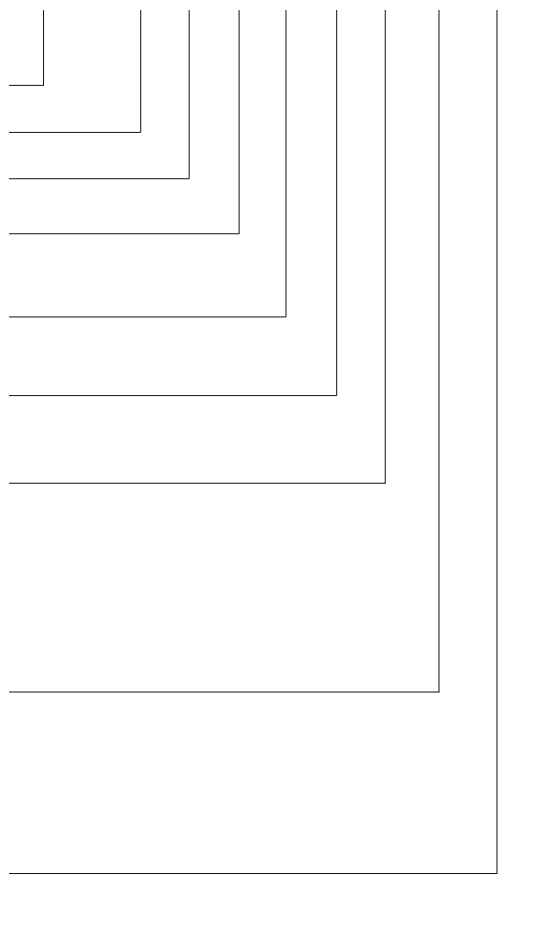

*Note: LED colours are denoted left to right from the panel side front view. Refer Page 108

** Light Pipes not available with termination option V, order V2 or H only

XLRNET A AND B TYPE PRINTED CIRCUIT BOARD CONNECTORS

PCB LAYOUT FRONT VIEW

HORIZONTAL

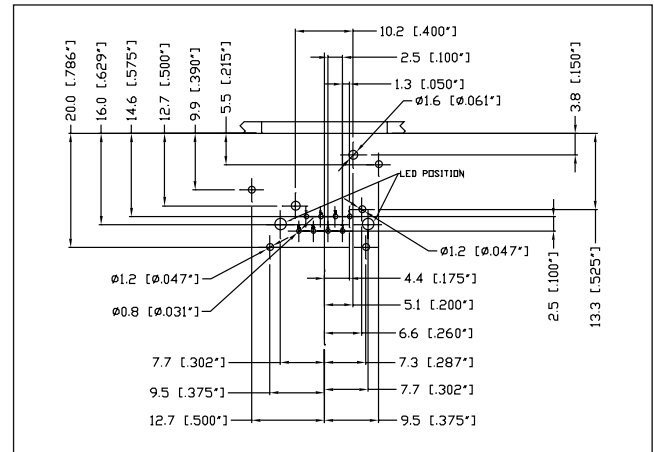
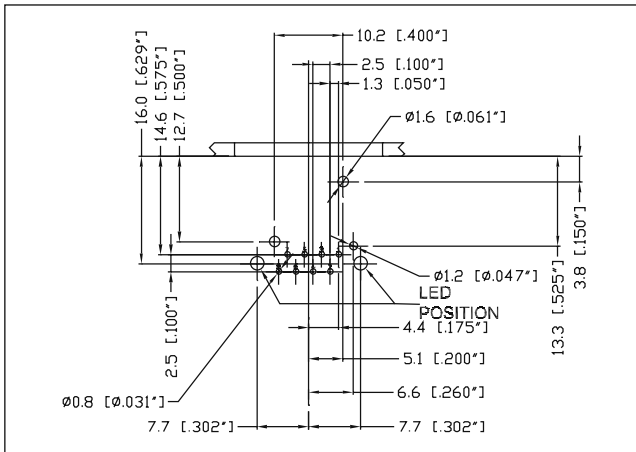

RJX8FB5HLPB
RJX8FB6HLPB

RJX8FB5HLPEB
RJX8FB6HLPEB

VERTICAL

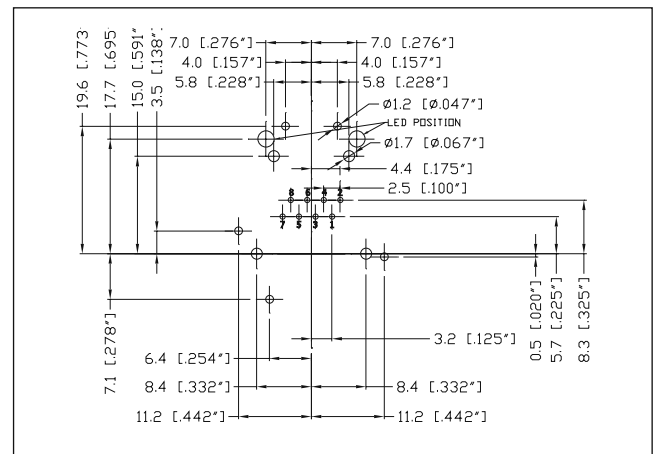
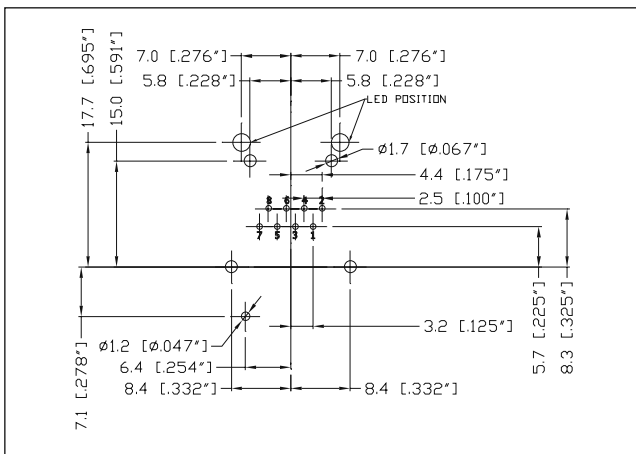

RJX8FB5V2LPB
RJX8FB6V2LPB

RJX8FB5V2LPEB
RJX8FB6V2LPEB

Data Connectors

XLRnet Series A & B Type Chassis Receptacles

PANEL CUTOUT DIMENSIONS FRONT VIEW

HORIZONTAL

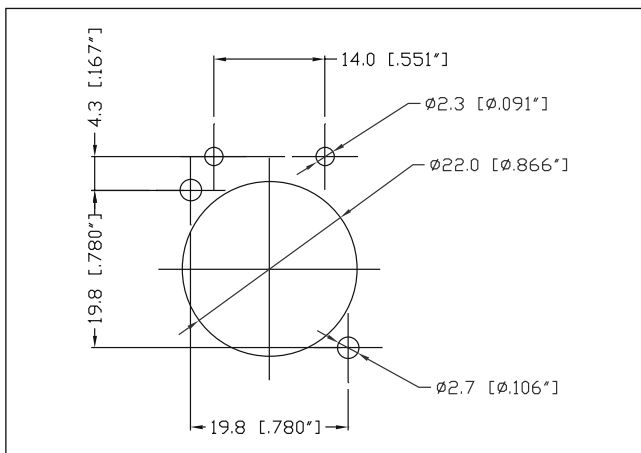

RJX8FB5HLPEB
RJX8FB6HLPEB
RJX8FB5HLPB
RJX8FB6HLPB

VERTICAL

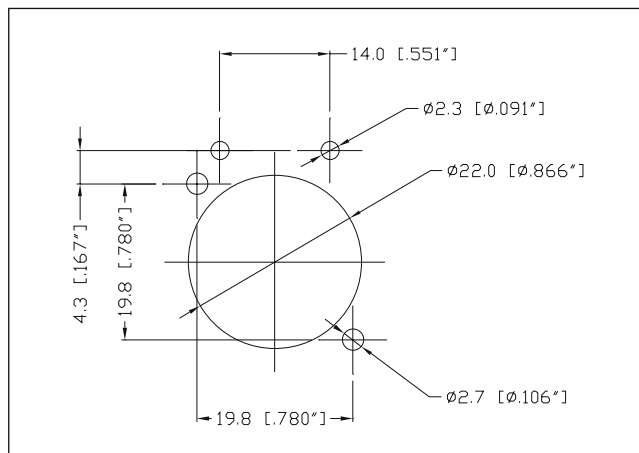

RJX8FB5V2LPEB
RJX8FB6V2LPEB
RJX8FB5V2LPB
RJX8FB6V2LPB



XLRNET SERIES D TYPE CHASSIS RECEPTACLES

Features:

- RJ45 Class D (10/100 Base-T), CAT5E (1000 Base-T) or CAT6 (10GBASE-T) Ethernet performance
- D type XLR standard housings
- IDC Punchdown block
- Thru-adaptor / Feedthrough
- Horizontal or Vertical PCB

Part Number Breakdown: Page 107

Specifications: Page 109

PCB Footprints: Page 108

Recommended Fastener: Page 155

PRODUCT - FIGURE	DRAWING	Dimensions in mm (inches)	DESCRIPTION	TYPE	PART NUMBER
			XLrnet chassis, D type, Feedthrough, Nickel Finish	CAT5E	RJX8FD5T
			XLrnet chassis, D type, IDC Terminals, 110 type, Nickel Finish	CAT5E	RJX8FD5110
			XLrnet chassis, D type, IDC Terminals, 110 type, Nickel Finish	CAT6	RJX8FD6110
			XLrnet chassis, D type, IDC Terminals, Nickel Finish	CAT5E	RJX8FD5I
			XLrnet chassis, D type, IDC Terminals, Nickel Finish	CAT6	RJX8FD6I
			XLrnet chassis, D type, Horizontal PCB, Nickel Finish	Class D	RJX8FD3HB
			XLrnet chassis, D type, Horizontal PCB, Nickel Finish	CAT5E	RJX8FD5HB
			XLrnet chassis, D type, Horizontal PCB, Nickel Finish	CAT6	RJX8FD6HB
			XLrnet chassis, D type, Vertical PCB, Nickel Finish	Class D	RJX8FD3VB
			XLrnet chassis, D type, Vertical PCB, Nickel Finish	CAT5E	RJX8FD5VB
			XLrnet chassis, D type, Vertical PCB, Nickel Finish	CAT6	RJX8FD6VB

Data Connectors

XLRnet Series D Type Chassis Receptacles

PRODUCT - FIGURE	DRAWING	Dimensions in mm (inches)	DESCRIPTION	TYPE	PART NUMBER
			XLRnet chassis, D type (IP54), Feedthrough, Nickel Finish	CAT5E	RJXS8FD5T
			XLRnet chassis, D type (IP54), IDC Terminals, 110 type, Nickel Finish	CAT5E	RJXS8FD5110
				CAT6	RJXS8FD6110
			XLRnet chassis, D type (IP54), IDC Terminals, Nickel Finish	CAT5E	RJXS8FD5I
				CAT6	RJXS8FD6I
			XLRnet chassis, D type (IP54), Horizontal PCB, Nickel Finish	Class D	RJXS8FD3HB
				CAT5E	RJXS8FD5HB
				CAT6	RJXS8FD6HB
			XLRnet chassis, D type (IP54), Vertical PCB, Nickel Finish	Class D	RJXS8FD3VB
				CAT5E	RJXS8FD5VB
				CAT6	RJXS8FD6VB
			XLRnet chassis with Protective cap, D type (IP54), Feedthrough, Nickel Finish	CAT5E	RJXS8FG5T
			XLRnet chassis with Protective cap, D type (IP54), IDC Terminals, 110 type, Nickel Finish	CAT5E	RJXS8FG5110
				CAT6	RJXS8FG6110
			XLRnet chassis with Protective cap, D type (IP54), IDC Terminals, Nickel Finish	CAT5E	RJXS8FG5I
				CAT6	RJXS8FG6I
			XLRnet chassis with Protective cap, D type (IP54), Horizontal PCB, Nickel Finish	Class D	RJXS8FG3HB
				CAT5E	RJXS8FG5HB
				CAT6	RJXS8FG6HB
			XLRnet chassis with Protective cap, D type (IP54), Vertical PCB, Nickel Finish	Class D	RJXS8FG3VB
				CAT5E	RJXS8FG5VB
				CAT6	RJXS8FG6VB

PART NUMBER BREAKDOWN

XLRnet D TYPE Chassis Connectors

E. G. **RJX8FD3TB**
RJX (Series Prefix), **8** (Contacts), **F**emale **D** type, **3** Class **D** Thru Adaptor, **B**ulk Packaged

SERIES PREFIX	RJX =	Series Prefix
CONTACT LAYOUT	8 =	RJ45 type
GENDER	F =	Receptacle housing
SHELL SERIES	D =	D Type
TRANSMISSION CLASS	3 = 5 = 6 =	Class D CAT 5e CAT 6
TERMINATION	H = I = 110 = T = V =	Horizontal Printed Circuit Board IDC Punch Down Block IDC 110 Punch Down Block Thru adaptor / Feedthrough Vertical Printed Circuit Board
LOCKING MECHANISM	Blank = P =	Latching Push lever supplied separately for customer installation (Contact factory for detailed fitting instructions)
PACKAGING	Blank = B =	Individual Bulk packed

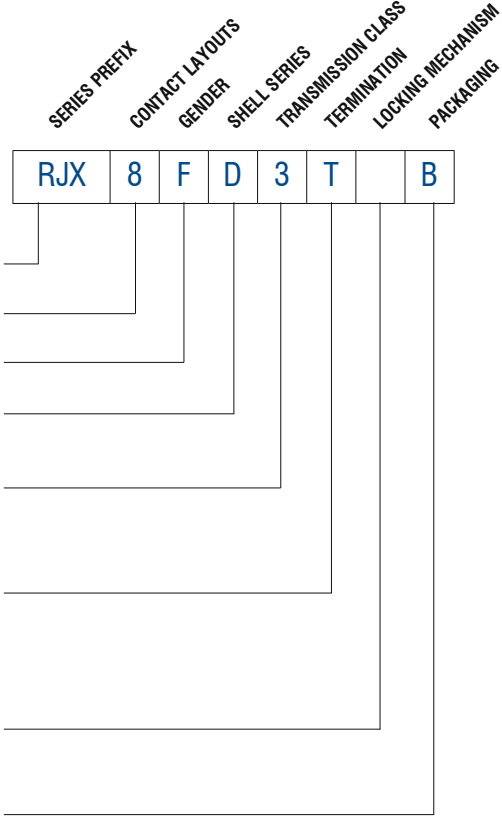

*Note: LED colours are denoted left to right from the panel side front view. Refer Page 108

STANDARD DATA XLRnet CHASSIS RECEPTACLES

		VALUE		
		Class D	CAT5E	CAT6
GENERAL CHARACTERISTICS	Number of contacts	8		
	Contact Arrangement	RJ45		
	Termination	Printed Circuit Board (PCB) - through hole, Feedthrough, IDC Terminal		
	Flammability	UL94V-0		
	Environmental	Complies with EU RoHS 2 Directive 2011/65/EU		
	Solderability	MIL-STD 202, Method 208		
ELECTRICAL CHARACTERISTICS	Rated current per contact	1.5 A		
	Rated Voltage	125V AC		
	Typical Contact Resistance	20mΩ		
	Insulation Resistance	> 500MΩ		
	Dielectric Strength	1000 VAC, 60 secs		
	Max. Frequency	100Mhz	100MHz	250MHz
	Ethernet Standard	10/100 BASE-T	1000 BASE-T	10GBASE-T
	Transmission Spec.	EIA/ TIA568-C.2, ISO/IEC 11801, EN50173		
	PoE	802.3at Type 2	Types 1 to 4 and IEC60603-7 compliant	
	LED Type	Round, single pole, indicator		
CLIMATIC CHARACTERISTICS	Protection Class - RJX - RJXS	IP40 (with EMI/RFI shield) IP54		
	Operating Temperature	-40°C to +80°C (-40°F to +176°F)		
MECHANICAL CHARACTERISTICS	Weight** - A & B Housing - Shielded Housing - D Shell	11g (0.024lb) 17g (0.037lb) 25g (0.055lb)		
	Mechanical Operations	1000		
	Insertion and Withdrawal Force	≤ 21N		
	Latch	Spring Steel		
	Panel Thickness max.	3mm		
	Mounting screw torque max.	0.35Nm		
	Fastener	Self-Tapping screw M2.5		
MATERIALS	Connector Shell / Housing	Thermoplastic, DSM Stanyl UL94V-0, 30% GF / PA66 30% GF		
	Flange (A type)	Thermoplastic, DSM Stanyl UL94V-0, 30% GF		
	Flange (B type)	Diecast Zinc Alloy 3		
	Flange Finish (B type)	Satin Nickel		
	Contact	Phosphor Bronze		
	Contact Finish - Ground - RJ45	0.38μm Au over 1.27μm Ni 1.27μm Au over 1.27μm Ni		
	Metal Hood Shield EMI/RFI	Brass, nickel plated		
	Latch lock and Spring	Spring steel		

Rev 5 - 11/2023

**Approximate weight in grams not including packaging. Please contact us for exact weight for shipping purposes.

Data Connectors

USB/HDMI Series



USB/HDMI SERIES

Features:

- Data connectors
- Feedthrough adaptors
- USB 3 Type A
- HDMI receptacles

Options: Nickel or Black Shell Finish

PRODUCT - FIGURE	DRAWING	Dimensions in mm (inches)	DESCRIPTION	VARIATIONS	PART NUMBER
	<p>FRONT VIEW</p> <p>REAR VIEW</p>		USB 3.0, Feedthrough adapter, D Flange, Nickel Finish	Type A / Type A	AC-USB3-AA
			USB 3.0, Feedthrough adapter, D Flange, Black Finish	Type A / Type A	AC-USB3-AAB
			HDMI, Feedthrough adapter, D Flange, Nickel Finish	HDMI / HDMI	AC-HDMI-RR
			HDMI, Feedthrough adapter, D Flange, Black Finish	HDMI / HDMI	AC-HDMI-RRB

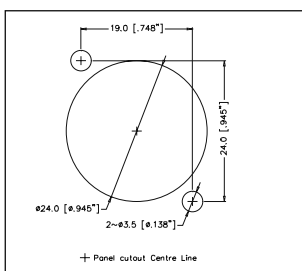

PANEL CUTOUT DIMENSIONS

FRONT VIEW

AC-****

USB/HDMI TECHNICAL DATA

		VALUE	
GENERAL CHARACTERISTICS	Type	USB 3.0	HDMI 2.0
	Termination	Thru-adaptor	
	Max. Wire Gauge - Stranded Wire	AWG 14 - 2.5mm ²	
	Flammability rating of insulating plastics	UL94V-0	
	Solderability, complies with	IEC 68-2-20	
	Environmental	Complies with EU RoHS 2 Directive 2011/65/EU	
ELECTRICAL CHARACTERISTICS	Current Carrying Capacity	10A (Depends on Mating Connector)	
	Typical Contact Resistance	≤10mΩ (Depends on Mating Connector)	
	Insulation resistance (initial) After Damp Heat Test	>2GΩ ≥ 10 ⁹ Meg Ω	
	Dielectric Strength	1500 V dc	
CLIMATIC CHARACTERISTICS	Protection Class	IP40	
	Operating Temperature	-25°C to +75°C (-13°F to +167°F)	
MECHANICAL CHARACTERISTICS	Insertion and Withdrawal Force	≥10N - ≤30N (depends on mating connector)	
	Cable O.D.	3mm to 7mm (0.118" to 0.275")	
	Mechanical Operations	1000 mating cycles	
	Weight - Cable Mount - Panel Mount	18g (0.039lb) 30g (0.066lb)	
MATERIALS	Connector Shell Material (Plugs)	Diecast Zinc Alloy EZDA No.3	
	Connector Shell Finish	Satin Nickel or Coloured Polyester	
	Insulators	PA66	
	Cable Bushing	Thermoplastic Polyurethane	
	Contacts	Brass Alloy	
	Plating	Gold Flash	

Rev 2 - 03/2021

¹⁾ Approximate weight only, does not include packaging. Please contact us for exact weight for shipping purposes.



1/4" PHONE CONNECTORS

Amphenol offers two ranges of 1/4" Phone plug connectors to satisfy the needs of the manufacturer and the end user. The PRO – a heavy duty on-road plug and the MUSICIAN - a solid performing general use plug. Both series offer different features and benefits and the most suitable type will be determined by application, budget and personal choice.

Applications

- Audio Cables and Snakes
- Amplifiers
- Mixing desks
- Patch panel

PRO RANGE 1/4" Phone Plug T-Series

Features / Options

- Mono or Stereo (TRS)
- Switching Plugs
- Nickel or Gold contact plating
- Straight or Right Angle
- Optional heavy duty metal backshell / boot
- Increased solder area on ground contact
- "Jaws" Cable Clamp
- Precision machined contacts
- Coloured Grommet
- JUMBO Series Plugs

PRO RANGE 1/4" Phone Plug Q-Series

Features / Options

- Mono or Stereo (TRS)
- Slimline design
- Quick and Easy to assemble
- Nickel or Gold contact plating
- Chuck style cable clamp
- Nickel or Black shell finish
- Molded backshell

MUSICIAN RANGE 1/4" Phone Plug

Features / Options

- Mono or Stereo (TRS)
- Compact Shell
- Straight or Right angle
- Flexible grommet cable protection
- Nickel or Gold contact plating
- Satin Nickel or Black finish
- Coloured Grommet

Jaws Cable Clamp Options for T-Series*



Standard Jaws cable clamp (Black), Cable O.D 3mm to 6mm (0.118" to 0.236")



Large Jaws cable clamp (Purple), Cable O.D 6mm to 7mm (0.236" to 0.275")

*Note: Applicable to T-Series straight cable connectors only. Refer to page 122 for right angle connector Jaws cable clamp specifications.

Chuck Clamp for Q-Series



Standard Chuck clamp (Black), Cable O.D 3mm to 7mm (0.118" to 0.275")

Musician Range Cable Clamp Options



M-Series, Cable O.D 3mm to 6.5mm (0.118" to 0.256")



M-Series II, Cable O.D 6.5mm to 8mm (0.256" to 0.315")

Ordering Codes

We have listed the more common ordering codes in each section. Refer to our 1/4" plug product feature matrix found on the next page for assistance on selecting the right plug for your application.

Simple steps to guide you in using this catalogue

- 1) Identify the product group listed in Contents on page 1 and go directly to that page number.
- 2) Each product group cover page then details information and options available.
- 3) Refer to the product detail pages and identify the product you require pictorially.
- 4) Read the product description column for the products standard features.
- 5) Use variations column to determine your choice.
- 6) Identify part number.
- 7) In the event the particular option you require is not listed please refer to the part number breakdown page at the end of each section.
- 8) Please contact us directly if you have any further problems.

1/4" PLUG FEATURE MATRIX

FEATURES		T SERIES (STRAIGHT)	T SERIES (RIGHT ANGLE)	JUMBO T SERIES	SWITCHPLUG T SERIES (STRAIGHT)	SWITCHPLUG T SERIES (RIGHT ANGLE)	Q SERIES	M SERIES	M SERIES II	CUSTOM SERIES ¹
PRECISION MACHINED CONTACTS		X	X	X	X	X	X	X	X	X
CENTER CONTACT	1 pc. Center Contact	X	X	X	X	X				X*
	2 pc Press Fit Tip/Center Contact						X	X	X	X*
BARREL:	Machined Tube	X	X	X	X	X				
	Precision Extruded Tube						X	X	X	X
JAWS CABLE CLAMP		X	X		X	X				
MIN. CABLE OD	Black Jaw: 3mm/0.118"	X	X		X	X				
	Purple Jaw: 6mm/0.236"	X			X					
	Purple Jaw: 5.5mm/0.216"		X			X				
MAX. CABLE OD	Black Jaw: 6mm/0.236"	X			X					
	Black Jaw: 5.5mm/0.216"		X			X				
	Purple Jaw: 7.5mm/0.295"	X			X					
	Purple Jaw: 6.5mm/0.255"		X			X				
CHUCK CABLE CLAMP										
MIN. CABLE OD	Black Chuck: 3.5mm/0.137"						X			
MAX. CABLE OD	Black Jaw: 7mm/0.275"						X			
STANDARD CABLE CLAMP				X				X	X	X
MIN. CABLE OD	7.5mm/0.295"			X						
MAX. CABLE OD	6mm/0.236"							X		
	8mm/0.315"								X	
	8.8mm/0.345"									X
	10.5mm/0.413"			X						
BACKSHELL FINISH	Satin Nickel	X	X	X	X	X	X	X	X	
	Black	X	X	X	X	X	X	X	X	
	Bright Nickel									X
	Bright Gold									X
CONTACT MATERIAL/ FINISH OPTIONS	Brass/Nickel (Ni)	X	X	X	X	X	X	X	X	X
	Brass/Gold over 2µm (Ni)	X	X	X	X	X	X	X	X	X

¹Custom Series - Minimum order quantities apply. Contact us for further details.

Plugs & Jacks

T Series Plugs



T SERIES PLUGS

Features:

- Mono or Stereo (TRS).
- Stylised shell design with Ergonomic grip.
- Straight or Right Angle.
- Robust diecast shell in Satin nickel or Black finish.
- Nickel or Gold contact plating.
- Keyed shell.
- Optional heavy duty metal backshell / boot.
- Great solderability.
- Increased solder area on ground contact.
- "Jaws" Cable Clamp.
- Precision machined contacts.
- Quick and easy assembly.







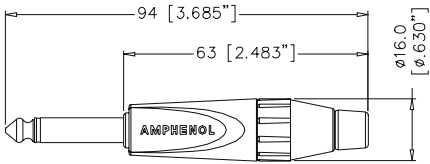

Options: Gold Contacts, Large or Small Jaws Cable Clamp, Black Shell, Metal Backshell / Boot, Bulk Pack. Coloured grommets (ordered separately)

Part Number Breakdown: Page 97 Specifications: Page 98

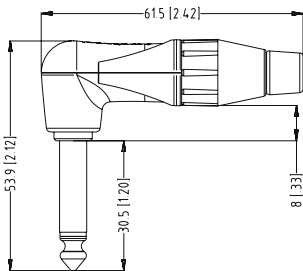
PRODUCT - FIGURE	DRAWING	DESCRIPTION	VARIATIONS	PART NUMBER
		1/4" (6.35mmø) Mono Phone plug, Jaws cable clamp, Thermoplastic back- shell, Satin finish.	Standard	TM2P
			Gold Plated Contacts	TM2P-AU
			Large Cable Clamp	TM2PJ
			Bulk Pack	TM2P BULK
		1/4" (6.35mmø) Mono Phone plug, Jaws cable clamp, Thermoplastic back- shell, Black finish.	Standard	TM2PB
			Gold Plated Contacts	TM2PB-AU
			Large Cable Clamp	TM2PBJ
			Bulk Pack	TM2PB BULK
		1/4" (6.35mmø) Stereo Phone plug, Jaws cable clamp, Thermoplastic back- shell, Satin finish.	Standard	TS3P
			Gold Plated Contacts	TS3P-AU
			Large Cable Clamp	TS3PJ
			Bulk Pack	TS3P BULK
		1/4" (6.35mmø) Stereo Phone plug, Jaws cable clamp, Thermoplastic back- shell, Black finish.	Standard	TS3PB
			Gold Plated Contacts	TS3PB-AU
			Large Cable Clamp	TS3PBJ
			Bulk Pack	TS3PB BULK

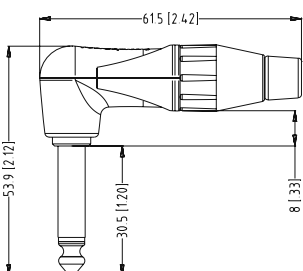
Plugs & Jacks

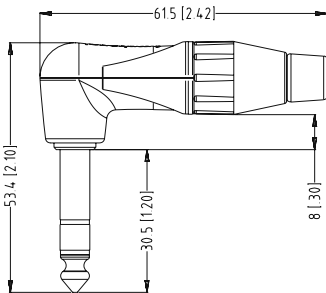
T Series Plugs

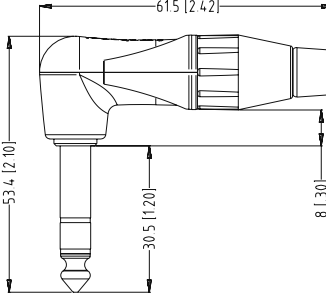
PRODUCT - FIGURE	DRAWING	DESCRIPTION	VARIATIONS	PART NUMBER
		1/4" (6.35mmø) Mono Phone plug, Jaws cable clamp, Metal backshell, Satin finish.	Standard	TM2PN
			Gold Plated Contacts	TM2PN-AU
			Large Cable Clamp	TM2PNJ
			Bulk Pack	TM2PN BULK
		1/4" (6.35mmø) Mono Phone plug, Right angle, Jaws cable clamp*, Thermoplastic back- shell, Satin finish.	Standard	TM2RJ
			Gold Plated Contacts	TM2RJ-AU
		1/4" (6.35mmø) Mono Phone plug, Right angle, Jaws cable clamp*, Thermoplastic back- shell, Black finish.	Standard	TM2RBJ
			Gold Plated Contacts	TM2RBJ-AU
			Bulk Pack	TM2RBJ BULK
		1/4" (6.35mmø) Stereo Phone plug, Right angle, Jaws cable clamp*, Thermoplastic back- shell, Satin finish.	Standard	TS3RJ
			Gold Plated Contacts	TS3RJ-AU
		1/4" (6.35mmø) Stereo Phone plug, Right angle, Jaws cable clamp*, Thermoplastic back- shell, Black finish.	Standard	TS3RBJ
			Gold Plated Contacts	TS3RBJ-AU

*NOTE: Refer to page 122 for Jaws cable clamp specifications applicable to right angle connectors.

Plugs & Jacks

T Series (Jumbo) Plugs



T SERIES (JUMBO) PLUGS

Features:

- JUMBO Cable clamping capacity
- Suits Cable OD 7.5mm (0.295") to 10.5mm (0.413")
- Mono or Stereo (TRS).
- Stylised shell design with Ergonomic grip.
- Robust diecast shell in Satin nickel or Black finish.
- Nickel or Gold contact plating.
- Keyed shell.
- Great solderability.
- Increased solder area on ground contact.
- Precision machined contacts.
- Quick and easy assembly.

Options: Gold Contacts, Bulk Pack

Specifications: Page 122

PRODUCT - FIGURE	DRAWING	DESCRIPTION	VARIATIONS	PART NUMBER
		1/4" (6.35mm \varnothing) JUMBO Mono Phone plug, Thermoplastic back- shell, Satin finish.	Standard	JM2P
			Gold Plated Contacts	JM2P-AU
			Bulk Pack	JM2P BULK
		1/4" (6.35mm \varnothing) JUMBO Mono Phone plug, Thermoplastic back- shell, Black finish.	Standard	JM2PB
			Gold Plated Contacts	JM2PB-AU
		1/4" (6.35mm \varnothing) JUMBO Stereo Phone plug, Thermoplastic back- shell, Satin finish.	Standard	JS3P
			Gold Plated Contacts	JS3P-AU
		1/4" (6.35mm \varnothing) JUMBO Stereo Phone plug, Thermoplastic back- shell, Black finish.	Standard	JS3PB
			Gold Plated Contacts	JS3PB-AU

NOTE: Contact factory for availability of metal backshells.

PART NUMBER BREAKDOWN

T-SERIES (PRO RANGE)

E. G . **TS3PBMJ-AU BULK**
T (Series Prefix), **S3**(Stereo), **P**lug **B**lack, **M**etal Nut (Black), **J** (Large Jaws),
- AU (Gold Plated Contacts), **Bulk** Packaged.

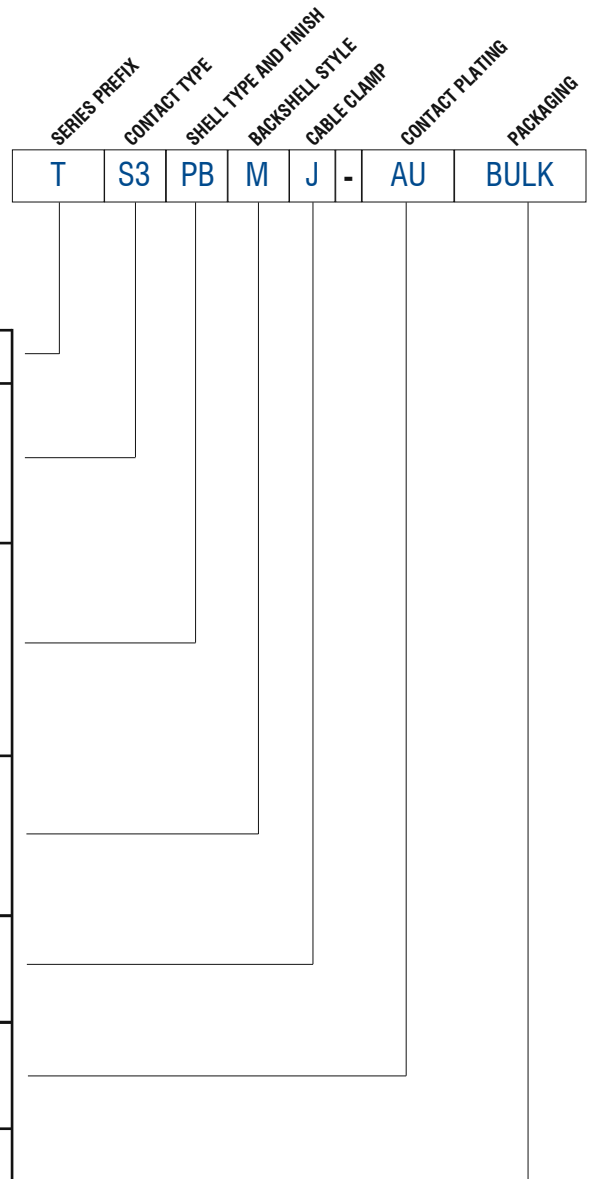

SERIES PREFIX	T	=	Series Prefix
CONTACT TYPE	M1	=	Switch Plug
	M2	=	2 Pole (mono)
	S3	=	3 Pole, tip/ring/sleeve (stereo)
SHELL TYPE AND FINISH	P	=	Plug Satin Nickel
	PB	=	Plug Matt Black
	R	=	Right Angle Plug Satin Nickel
	RB	=	Right Angle Plug Matt Black
BACKSHELL TYPE	Blank	=	Plastic Nut
	M	=	Metal Nut - Black
	N	=	Metal Nut - Satin Nickel
CABLE CLAMP	Blank	=	Small Jaws
	J	=	Large Jaws
CONTACT PLATING	Blank	=	Nickel Plated Contacts (Standard)
	AU	=	Gold Plated Contacts
PACKAGING	Blank	=	Individual Bags
	BULK	=	Bulk Packed

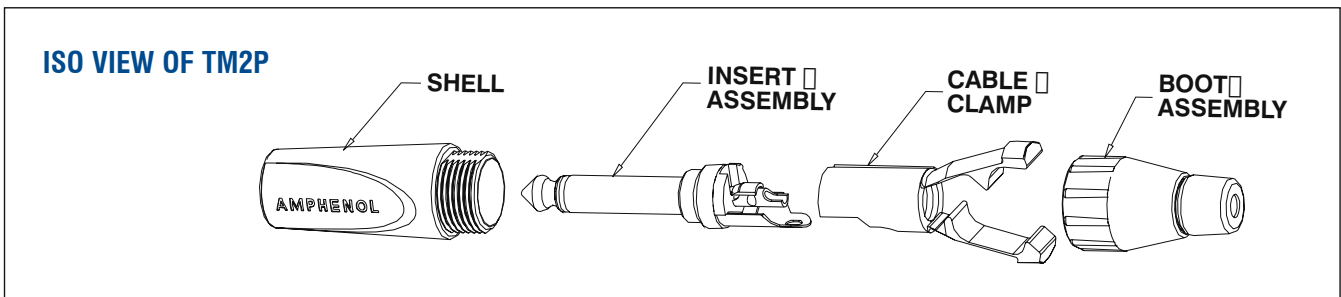

Plugs & Jacks

T-Series SwitchPlug



T-SERIES SWITCHPLUG

The Amphenol T series SwitchPlug uses a unique 360 degree precision sliding helical spring contact design to quietly and accurately switch the signal circuit safely to ground during instrument changes under load, thereby avoiding annoying thumps, pops and squeals. The sliding ring contact self-cleans every time the plug is connected preventing excessive build up of oxidization and contamination. Activation is directly off the jacks full front face assuring a positive reference point every time, and as it works instantaneously on the main circuits there is no need for the use of magnets or other elaborate switching mechanisms.

WARNING!
For use with
instrument (guitar)
applications only.

Part Number Breakdown: Page 117
Specifications: Page 122

PRODUCT - FIGURE	DRAWING	Dimensions in mm (inches)	DESCRIPTION	VARIATIONS	PART NUMBER
			1/4" (6.35mm \varnothing) Switch Phone plug, Jaws cable clamp, Thermoplastic backshell, Satin finish	Standard Gold Plated Contacts Large Cable Clamp	TM1P TM1P-AU TM1PJ
			1/4" (6.35mm \varnothing) Switch Phone plug, Jaws cable clamp, Thermoplastic backshell, Black finish	Standard Gold Plated Contacts Large Cable Clamp	TM1PB TM1PB-AU TM1PBJ
			1/4" (6.35mm \varnothing) Switch Phone plug, Right angle, Jaws cable clamp*, Thermoplastic backshell, Satin Finish	Standard Gold Plated Contacts	TM1RJ* TM1RJ-AU*
			1/4" (6.35mm \varnothing) Switch Phone plug, Right angle, Jaws cable clamp*, Thermoplastic backshell, Black Finish	Standard Gold Plated Contacts	TM1RBJ* TM1RBJ-AU*

*NOTE: Refer to page Page 122 for Jaws cable clamp specifications applicable to right angle connectors.

SwitchPlug - User Instruction

CAUTION! Use with instrument (guitar) cables only.
DO NOT connect to amplifier output.
Equipment damage may result from incorrect use.

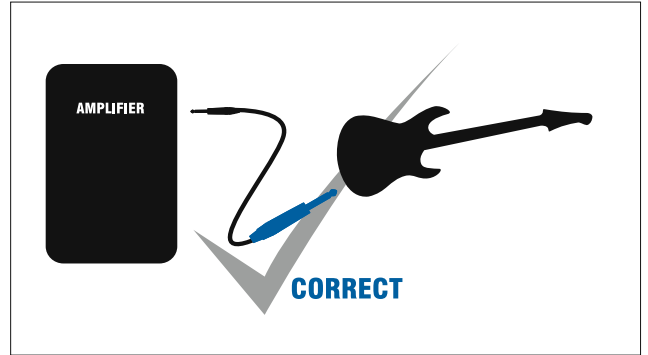
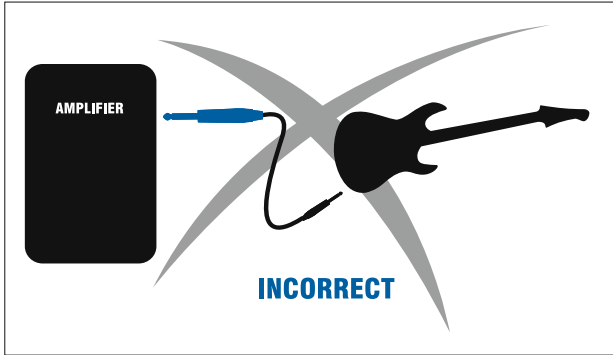

SwitchPlug - Technology*

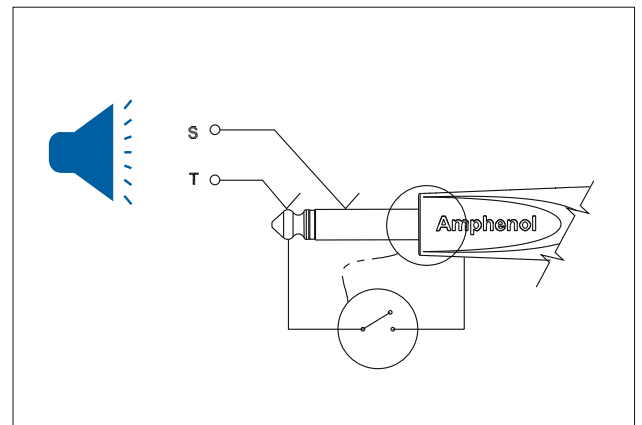
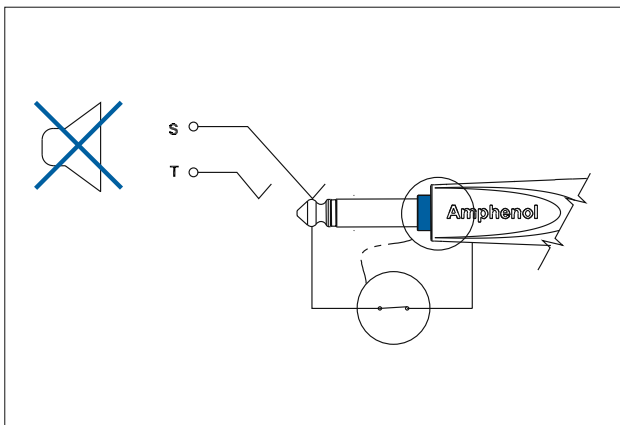

*US Patent No. 8,162,697

Plugs & Jacks

Q Series Plugs



Q SERIES PLUGS

Features:

- Mono or Stereo (TRS)
- Slimline design
- Quick and Easy to assemble
- Nickel or Gold contact plating
- Chuck style cable clamp
- Nickel or Black shell finish
- Molded backshell

Clamp Info:



Standard Chuck clamp (Black), Cable O.D 3mm to 7mm (0.118" to 0.275")





Options: Gold Plated Contacts, Black Shell, Bulk Pack.

Specifications: Page 122

PRODUCT - FIGURE	DRAWING	Dimensions in mm (inches)	DESCRIPTION	VARIATIONS	PART NUMBER
			1/4" (6.35mmø) Mono Phone plug, Chuck cable clamp, Molded boot, Satin Finish	Standard	QM2P
			1/4" (6.35mmø) Mono Phone plug, Chuck cable clamp, Molded boot, Black Finish	Gold Plated Contacts	QM2PB-AU
			1/4" (6.35mmø) Stereo Phone plug, Chuck cable clamp, Molded boot, Satin Finish	Standard	QS3P
			1/4" (6.35mmø) Stereo Phone plug, Chuck cable clamp, Molded boot, Black Finish	Gold Plated Contacts	QS3PB-AU

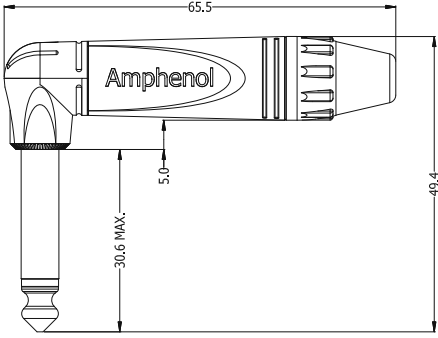
Plugs & Jacks

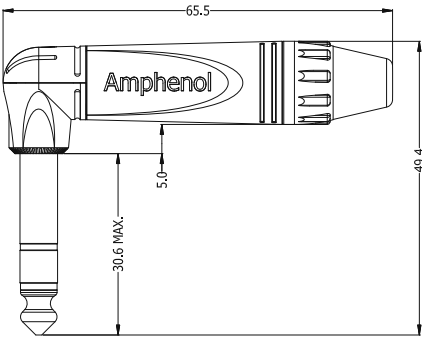
Q Series Plugs

PRODUCT - FIGURE	DRAWING	DESCRIPTION	VARIATIONS	PART NUMBER
		1/4" (6.35mmø) Mono Phone plug, Right angle Chuck cable clamp, Molded boot, Satin Finish	Standard	QM2R
		1/4" (6.35mmø) Mono Phone plug, Right angle Chuck cable clamp, Molded boot, Black Finish	Gold Plated Contacts	QM2RB-AU
		1/4" (6.35mmø) Stereo Phone plug, Right angle Chuck cable clamp, Molded boot, Satin Finish	Standard	QS3R
		1/4" (6.35mmø) Stereo Phone plug, Right angle Chuck cable clamp, Molded boot, Black Finish	Gold Plated Contacts	QS3RB-AU

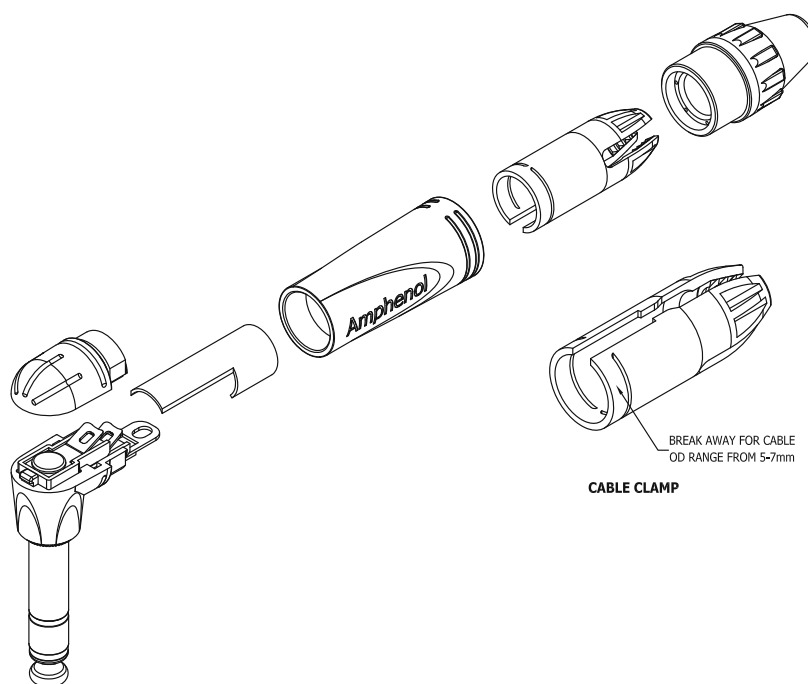

Plugs & Jacks

Q Series Plugs

1/4" PHONE PLUG TECHNICAL DATA

		VALUE			
		Straight	Right Angle	Jumbo	
GENERAL CHARACTERISTICS	Number of Contacts	3 Pole Tip Ring Sleeve (Stereo)			
	Termination	Solder			
	Max. Wire Gauge - Stranded Wire	2 Pole (Mono): AWG 16 - 1.5mm 3 Pole (Stereo): AWG 18 - 1mm			
	Flammability rating of insulating plastics	UL94V-0			
	Solderability, complies with	IEC 68-2-20			
	Environmental	Complies with EU RoHS 2 Directive 2011/65/EU			
ELECTRICAL CHARACTERISTICS	Current Carrying Capacity	10A (Depends on Mating Connector and Cable)			
	Typical Contact Resistance	Depends on Mating Connector			
	Insulation Resistance (initial)	>2GΩ			
	After Damp Heat Test	≥1GΩ			
CLIMATIC CHARACTERISTICS	Dielectric Withstand Voltage	2 Pole : 1.5 kV dc 3 Pole : 1 kV dc			
	Protection Class	IP40			
MECHANICAL CHARACTERISTICS	Operating Temperature	-25°C to +75°C (-13°F to + 167°F)			
	Insertion and Withdrawal Force	≥10N - ≤30N			
MATERIALS	Weight ¹	Thermoplastic Backshell	28g (0.061lb)		
		Metal Backshell	35g (0.077lb)		
	Typical Cable Retention Force	22kg to 44kg (50lb to 100lb) - Dependent on cable material and diameter.			
	Cable O.D.	Standard Jaw (T-Series)	3mm to 6mm (0.118" to 0.236")	3mm to 5.5mm (0.118" to 0.216")	N/A
		Large Jaw (T-Series)	6mm to 7mm (0.236" to 0.275")	5.5mm to 6.5mm (0.216" to 0.255")	N/A
		Standard Clamp (Q-Series)	3.5mm to 7mm (0.137" to 0.275")	N/A	N/A
		Jumbo	NA	NA	7.5mm to 10.5mm (0.295" to 0.413")
	Mechanical Operations	1000			
Connector Shell Material	Diecast Zinc Alloy EZDA No.3				
Shell Finish	Satin Nickel or Black Polyester				
Insulators	UL94 V-0 PBT Resin or Modified PPE Resin - Black				
Boot / Backshell	UL94 V-0 PBT Resin or Modified PPE Resin - Black or Metal CuZn ³⁹ Pb ³				
Cable Clamp	UL94 V-0 PBT Modified PPO Resin - Black				
Cable Bushing	Santoprene				
Contacts / Plating	Brass/Ni or Au over 2μm Ni				

Rev 6 - 10/2017

¹ Approximate weight only, does not include packaging. Please contact us for exact weight for shipping purposes.



MUSICIAN SERIES II PLUGS

Features:

- Mono or Stereo (TRS).
- AX Series inspired shell design.
- Large cable O.D. Entry to 8mm (0.315")
- Robust diecast shell in Satin nickel or Black finish.
- Nickel or Gold contact plating.
- Flexible grommet cable protection.
- Improved solderability.
- Precision machined contacts.
- Standard or Bulk packaging.

Clamp Info:



Cable O.D 6.5mm to 8mm (0.256" to 0.315")

Options: Black Shell, Gold contacts.
 Coloured grommets (ordered separately)







Specifications: Page 112

PRODUCT	DRAWING Dimensions in mm (inches)	DESCRIPTION	VARIATIONS	PART NO.
		1/4" (6.35mm \emptyset) Mono Phone plug, Diecast Shell, Satin finish, Flexible grommet.	Standard	ACPM-KN
			Gold Plated Contacts	ACPM-KN-AU
		1/4" (6.35mm \emptyset) Mono Phone plug, Diecast Shell, Black finish, Flexible grommet.	Standard	ACPM-KB
			Gold Plated Contacts	ACPM-KB-AU
		1/4" (6.35mm \emptyset) Stereo Phone plug, Diecast Shell, Satin finish, Flexible grommet.	Standard	ACPS-KN
			Gold Plated Contacts	ACPS-KN-AU
		1/4" (6.35mm \emptyset) Stereo Phone plug, Diecast Shell, Black finish, Flexible grommet.	Standard	ACPS-KB
			Gold Plated Contacts	ACPS-KB-AU

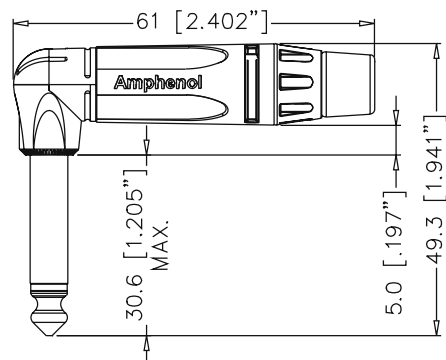
*NOTE: Refer to page 103 for Jaws cable clamp specifications applicable to right angle connectors.

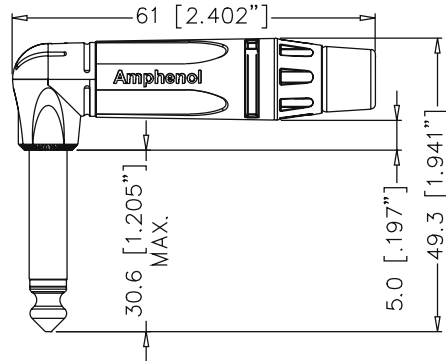
Plugs & Jacks

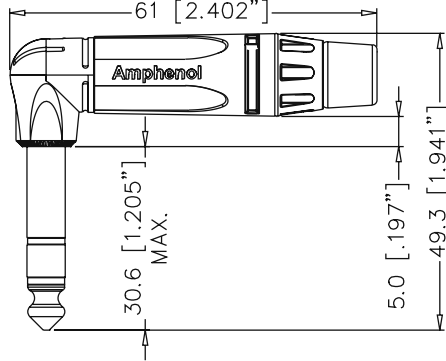
Musician Series II Plugs

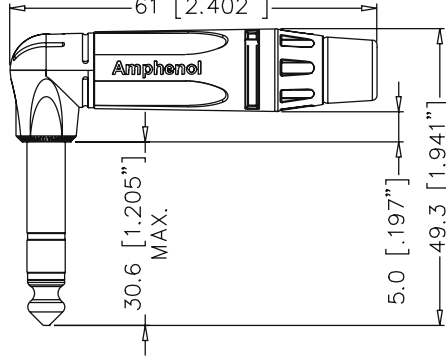
PRODUCT	DRAWING Dimensions in mm (inches)	DESCRIPTION	VARIATIONS	PART NO.
		1/4" (6.35mmø) Mono Phone plug, Right angle, Diecast Shell, Satin finish, Flexible grommet.	Standard	ACPM-TN
			Gold Contacts	ACPM-TN-AU
			Bulk Pack	ACPM-TN BULK
		1/4" (6.35mmø) Mono Phone plug, Right angle, Diecast Shell, Black finish, Flexible grommet.	Standard	ACPM-TB
			Gold Contacts	ACPM-TB-AU
			Bulk Pack	ACPM-TB BULK
		1/4" (6.35mmø) Stereo Phone plug, Right angle, Diecast Shell, Satin finish, Flexible grommet.	Standard	ACPS-TN
			Gold Contacts	ACPS-TN-AU
			Bulk Pack	ACPS-TN BULK
		1/4" (6.35mmø) Stereo Phone plug, Right angle, Diecast Shell, Black finish, Flexible grommet.	Standard	ACPS-TB
			Gold Contacts	ACPS-TB-AU
			Bulk Pack	ACPS-TB BULK

Plugs & Jacks

Musician Series II Plugs



Features:

- Mono or Stereo (TRS).
- Stylish shell design.
- Robust diecast shell in Satin nickel or Black finish.
- Nickel or Gold contact plating.
- Flexible grommet cable protection.
- Improved solderability.
- Precision machined contacts.
- Standard or Bulk packaging.
- Cable OD Entry to 6.5mm (0.256")

Options: Black Shell, Gold contacts.
Coloured grommets (ordered separately)

Specifications: Page 136

Clamp Info:







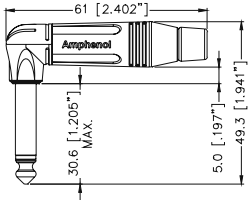

Cable O.D 3mm to 6.5mm
(0.118" to 0.256")

PRODUCT - FIGURE	DRAWING	DESCRIPTION	VARIATIONS	PART NUMBER
		1/4" (6.35mmø) Mono Phone plug, Diecast Shell, Satin finish, Flexible grommet.	Standard	ACPM-GN
			Gold Plated Contacts	ACPM-GN-AU
			Bulk Pack	ACPM-GN BULK
		1/4" (6.35mmø) Mono Phone plug, Diecast Shell, Black finish, Flexible grommet.	Standard	ACPM-GB
			Gold Plated Contacts	ACPM-GB-AU
			Bulk Pack	ACPM-GB BULK
		1/4" (6.35mmø) Stereo Phone plug, Diecast Shell, Satin finish, Flexible grommet.	Standard	ACPS-GN
			Gold Plated Contacts	ACPS-GN-AU
			Bulk Pack	ACPS-GN BULK
		1/4" (6.35mmø) Stereo Phone plug, Diecast Shell, Black finish, Flexible grommet.	Standard	ACPS-GB
			Gold Plated Contacts	ACPS-GB-AU
			Bulk Pack	ACPS-GB BULK

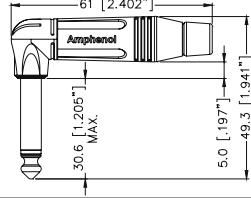
Plugs & Jacks

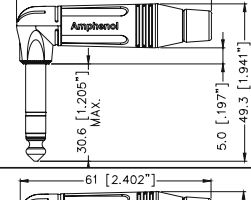
Musician Series II Plugs

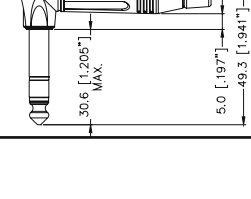
PRODUCT - FIGURE	DRAWING	DESCRIPTION	TYPE	PART NUMBER
		1/4" (6.35mmø) Mono Phone plug, Right angle, Diecast Shell, Satin finish, Flexible grommet.	Standard	ACPM-RN
			Gold contacts	ACPM-RN-AU
			Bulk Pack	ACPM-RN BULK
		1/4" (6.35mmø) Mono Phone plug, Right angle, Diecast Shell, Black finish, Flexible grommet.	Standard	ACPM-RB
			Gold contacts	ACPM-RB-AU
			Bulk Pack	ACPM-RB BULK
		1/4" (6.35mmø) Stereo Phone plug, Right angle, Diecast Shell, Satin finish, Flexible grommet.	Standard	ACPS-RN
			Gold contacts	ACPS-RN-AU
			Bulk Pack	ACPS-RN BULK
		1/4" (6.35mmø) Stereo Phone plug, Right angle, Diecast Shell, Black finish, Flexible grommet.	Standard	ACPS-RB
			Gold contacts	ACPS-RB-AU
			Bulk Pack	ACPS-RB BULK

PART NUMBER BREAKDOWN

M / M SERIES II (MUSICIAN RANGE)

E. G . **ACPM-GB-AU BULK**
ACP (Series Prefix), **M**ale, **G**(Shell Type), **B**lack,
- **AU** (Gold Plated Contacts), **Bulk** Packaged.

SERIES PREFIX	ACP = Series Prefix
CONTACT TYPE	M = 2 pole (Mono)
	S = 3 pole Tip/Ring/Sleeve (Stereo)
SHELL TYPE	G = M Series Straight
	K = M Series II Straight
	R = M Series Right Angle
	T = M Series II Right Angle
SHELL FINISH	N = Satin Nickel
	B = Matt Black
CONTACT PLATING	Blank = Nickel Plating
	AU = Gold Plated
PACKAGING	Blank = Individual Bags
	BULK = Bulk Packed

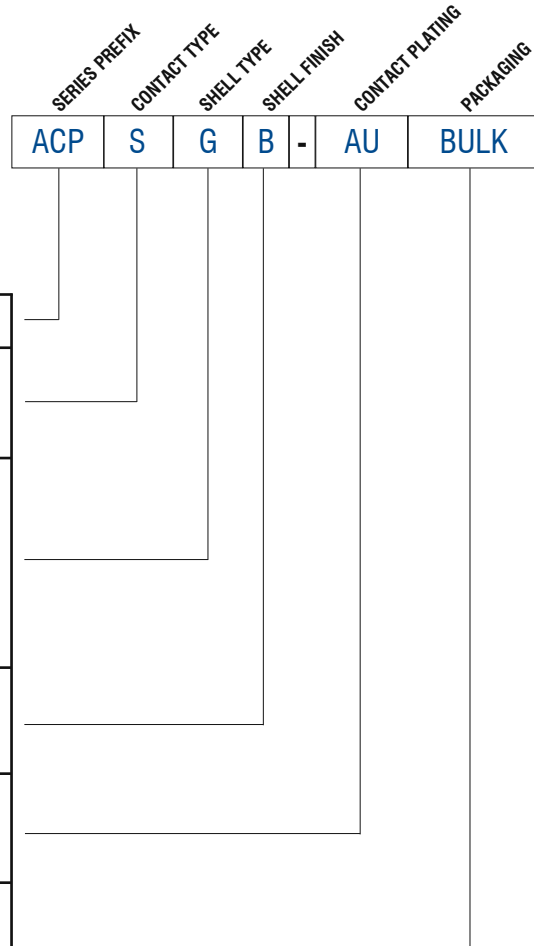

Plugs & Jacks

1/4" / 3.5mm Phone Jack Connectors



1/4" / 3.5MM PHONE JACK CONNECTORS

Amphenol phone connectors are available in 1/4" (6.35mm) and 3.5mm jack sockets or dual jack socket versions featuring combinations of both sizes. The standard heavy duty contacts provide excellent signal performance and the rugged designs excel in professional audio applications. Our wide range of options ensures we have the connector to suit your specific requirements. Custom jacks can also be developed to suit unique applications on request.

Applications

- Audio Cables and Snakes
- Amplifiers
- Speakers
- Mixing desks
- Rack mount equipment
- Patch panel

Features / Options – OEM RANGE Phone Jack

- Mono or Stereo (TRS)
- Stackable (Piggy back) mounting
- Vertical or horizontal PCB mount
- Mono and Stereo switched contacts
- Solder contacts
- Combo Contacts
- Metal nut
- Plastic Nut
- 1/4" (6.35mm)
- 3.5mm
- Dual 1/4" (6.35mm) and 3.5mm
- EMI Shielding plates
- Metal Mounting threads
- Plastic Mounting threads
- Chassis Ground connections
- Half, Full or No threads
- Grounded or Isolated Jacks

1/4" Phone Jack Grounding/ Shielding Options

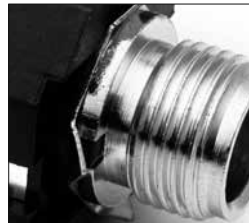

1/4" Gripper - Grounding points

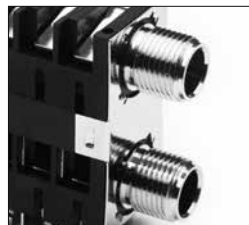

1/4" Shielding Plate

Ordering Codes

We have listed the more common ordering codes in each section. Please contact us if you need any further assistance.

Simple steps to guide you in using this catalogue

- 1) Identify the product group listed in Contents on page 1 and go directly to that page number.
- 2) Each product group cover page then details information and options available.
- 3) Refer to the product detail pages and identify the product you require pictorially.
- 4) Read the product description column for the products standard features.
- 5) Use variations column to determine your choice.
- 6) Identify part number.
- 7) In the event the particular option you require is not listed please refer to the part number breakdown page at the end of each section.
- 8) Please contact us directly if you have any further problems.

Plugs & Jacks

1/4" / 3.5mm Phone Jack Connectors

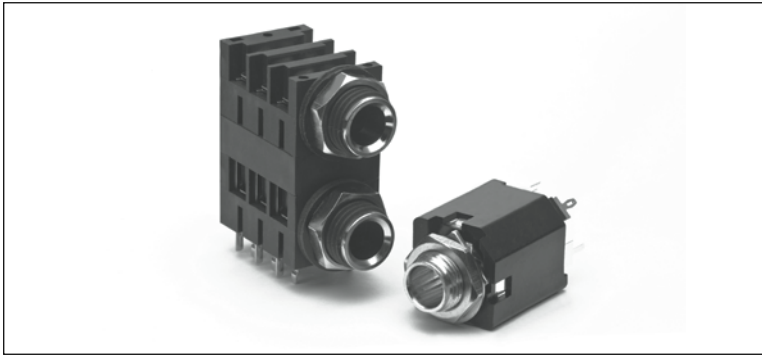

Features:

- 3.5mm and 6.35mm (1/4") options
- Mono or Stereo (TRS)
- Single or Dual mounting
- Vertical or Horizontal PCB mount
- Mono and Stereo with switching contacts
- Solder or Combo contacts
- Various mounting option

Schematic Chart: Page 134

Panel Cutouts: Page 133

PCB Footprints: Page 135

Specifications: Page 137

PRODUCT - FIGURE	DRAWING	DESCRIPTION	VARIATIONS	PART NUMBER
3.5MM PHONE JACKS				
		3.5mm Jack, Horizontal PCB, Plastic housing, Metal entry bore	Mono	ACJM-NH35
			Stereo	ACJS-NH35
		3.5mm Jack, Vertical PCB mount, Needle eye contacts, Plastic housing, Metal entry bore	Refer to Schematic Chart on page 134	ACJM-NV35-2 ACJM-NV35-2S ACJS-NV35-3 ACJS-NV35-3S ACJS-NV35-5
		3.5mm Jack, Vertical PCB mount, Needle eye contacts, Plastic housing, Metal thread and entry bore	Refer to Schematic Chart on page 134	ACJM-MV35-2 ACJM-MV35-2S ACJS-MV35-3 ACJS-MV35-3S ACJS-MV35-5
		3.5mm / 1/4" (6.35mmØ) Dual Phone Jack, (Piggyback), Horizontal PCB, Plastic housing, Metal nut and entry bore	Mono	ACJM-MHD985
			Stereo	ACJS-MHD985
		3.5mm / 1/4" (6.35mmØ) Dual Phone Jack, Vertical PCB mount, Needle eye contacts, Plastic housing, Metal nut and entry bore	Refer to Schematic Chart on page 134	ACJM-MVD985-2 ACJM-MVD985-2S ACJS-MVD985-3 ACJS-MVD985-3S ACJS-MVD985-5
1/4" PHONE JACKS HORIZONTAL				
		1/4" (6.35mmØ) Phone Jack, Horizontal Snap-fit PCB, Plastic housing, Half thread, Metal entry bore. Supplied without mounting hardware.	Mono	ACJM-HHDR
			Stereo	ACJS-HHDR

Plugs & Jacks

1/4" / 3.5mm Phone Jack Connectors

PRODUCT - FIGURE	DRAWING	Dimensions in mm (inches)	DESCRIPTION	VARIATIONS	PART NUMBER
		12.7 [.500"] 9.1 [.358"] 33.5 [1.319"] 6.50 [.256"] 4.50 [.177"] TYP 16.0 [.630"]	1/4" (6.35mm \varnothing) Phone Jack, Horizontal Snap-fit PCB, Plastic housing, Metal nut and entry bore	Mono	ACJM-MHDR
				Stereo	ACJS-MHDR
		12.7 [.500"] 8.6 [.339"] 33.0 [1.299"] 6.50 [.256"] 4.50 [.177"] TYP 16.0 [.630"]	1/4" (6.35mm \varnothing) Phone Jack, Horizontal Snap-fit PCB, Plastic housing, Metal thread, nut, washer and entry bore	Mono	ACJM-MHDRM
				Stereo	ACJS-MHDRM
		12.7 [.500"] 6.5 [.256"] 24.3 [.957"] 8.9 [.350"] 21.36 [.841"] 15.8 [.620"] 3.2 [.124"]	1/4" (6.35mm \varnothing) Offset Jack, Horizontal PCB mount, Plastic housing and entry bore with Half thread. Supplied without mounting hardware.	Refer to Schematic Chart on page 134	ACJM-HHOP
					ACJS-HHOP
		12.7 [.500"] 6.5 [.256"] 24.3 [.957"] 8.9 [.350"] 21.36 [.841"] 15.8 [.620"] 3.2 [.124"]	1/4" (6.35mm \varnothing) Offset Jack, Horizontal PCB mount, Plastic housing and entry bore with Half thread. Supplied without mounting hardware.	Refer to Schematic Chart on page 134	ACJM-HHOP-1
					ACJS-HHOP-1
		12.7 [.500"] 6.5 [.256"] 24.3 [.957"] 8.9 [.350"] 21.36 [.841"] 15.8 [.620"] 3.2 [.124"]	1/4" (6.35mm \varnothing) Offset Jack, Horizontal PCB mount, Plastic housing, thread and entry bore	Mono - Plastic Nut	ACJM-PHOP
				Mono - Metal Nut	ACJM-MHOP
				Stereo - Plastic Nut	ACJS-PHOP
				Stereo - Metal Nut	ACJS-MHOP
		12.7 [.500"] 6.5 [.256"] 24.3 [.957"] 8.9 [.350"] 21.36 [.841"] 15.8 [.620"] 3.2 [.124"]	1/4" (6.35mm \varnothing) Offset Jack, Horizontal PCB mount, Plastic housing, thread and entry bore. Non-switching sleeve contact with separate grounding to panel.	Refer to Schematic Chart on Page 110	ACJM-PHOP-1
				PHOP - Denotes Plastic Nut	ACJM-MHOP-1
				MHOP - Denotes Metal Nut	ACJS-PHOP-1
					ACJS-MHOP-1
		12.7 [.500"] 6.5 [.256"] 24.8 [.976"] 8.2 [.323"] 0.5 [.020"] 21.85 [.860"] 15.8 [.620"] 3.2 [.124"]	1/4" (6.35mm \varnothing) Offset Jack, Horizontal PCB mount, Plastic housing, Metal thread and entry bore with Chassis ground connection	Mono - Metal Nut	ACJM-MHOM
				Stereo - Metal Nut	ACJS-MHOM
		8.0 [.315"] 8.0 [.315"] 24.8 [.976"] 15.3 [.602"] 4.00 [.157"] TYP 20.0 [.787"]	1/4" (6.35mm \varnothing) Jack, Horizontal PCB mount, Plastic housing with metal insert	Mono - Plastic Nut	ACJM - PH
				Mono - Metal Nut	ACJM - MH

Plugs & Jacks

1/4" / 3.5mm Phone Jack Connectors

PRODUCT - FIGURE	DRAWING	Dimensions in mm (inches)	DESCRIPTION	VARIATIONS	PART NUMBER
			1/4" (6.35mmø) Jack, Horizontal PCB mount, Plastic housing with metal insert	Stereo - Plastic Nut	ACJS - PH
				Stereo - Metal Nut	ACJS - MH
			1/4" (6.35mmø) Jack, Horizontal Snap-fit PCB mount, Plastic housing with metal insert	Mono - Plastic Nut	ACJM-PHR
				Mono - Metal Nut	ACJM-MHR
				Stereo - Plastic Nut	ACJS-PHR
				Stereo - Metal Nut	ACJS-MHR
			1/4" (6.35mmø) Jack, Combination Horizontal PCB and Solder lug, Plastic housing with metal insert	Mono - Plastic Nut	ACJM-PC
				Mono - Metal Nut	ACJM-MC
				Stereo - Plastic Nut	ACJS-PC
				Stereo - Metal Nut	ACJS-MC
			1/4" (6.35mmø) Jack, Solder Lug, Plastic housing with metal insert	Mono - Plastic Nut	ACJM-PHS
				Mono - Metal Nut	ACJM-MHS
				Stereo - Plastic Nut	ACJS-PHS
				Stereo - Metal Nut	ACJS-MHS
			1/4" (6.35mmø) Jack, Solder Lug, Plastic housing and Bezel with threaded Metal nut.	Mono	ACJM-IHS
				Stereo	ACJS-IHS
			1/4" (6.35mmø) Jack, Horizontal PCB mount, Plastic housing and Bezel with threaded Metal nut.	Mono	ACJM-IH
				Stereo	ACJS-IH
1/4" PHONE JACKS HORIZONTAL DUAL			1/4" (6.35mmø) Dual Phone Jack (Compact Piggyback), Horizontal Snap-fit PCB, Plastic housing, Metal nut and entry bore	Mono	ACJM-MHDC
				Stereo	ACJS-MHDC
Stereo	ACJS-MHDCM				

Plugs & Jacks

1/4" / 3.5mm Phone Jack Connectors

PRODUCT - FIGURE	DRAWING	DESCRIPTION	VARIATIONS	PART NUMBER
		1/4" (6.35mmØ) Dual Phone Jack (Piggyback) Horizontal Snap-fit PCB, Plastic housing, Metal nut and entry bore	Mono	ACJM-MHD
			Stereo	ACJS-MHD
		1/4" (6.35mmØ) Dual Phone Jack (Piggyback) Shielding plate, Horizontal Snap-fit PCB, Plastic housing, Metal nut and entry bore	Mono	ACJM-MHDE
			Stereo	ACJS-MHDE
		1/4" (6.35mmØ) Dual Phone Jack (Piggyback), Horizontal Snap-fit PCB, Plastic housing, Metal thread, nut, washer and entry bore	Mono	ACJM-MHDM
			Stereo	ACJS-MHDM
		1/4" (6.35mmØ) Dual Phone Jack (Piggyback), Shielding plate Horizontal Snap-fit PCB, Plastic housing, Metal thread, nut and entry bore	Mono	ACJM-MHDEM
			Stereo	ACJS-MHDEM
1/4" PHONE JACKS VERTICAL		1/4" (6.35mmØ) Jack, Vertical PCB mount, Plastic housing, nut and entry bore	Refer to Schematic Chart on page 134	ACJM-PVB-2
	ACJM-PVB-2S			
	ACJS-PVB-3			
	ACJS-PVB-3S			
	ACJS-PVB-5			
		1/4" (6.35mmØ) Jack, Vertical PCB mount, Needle eye contacts, Plastic thread, Metal nut and insert	Refer to Schematic Chart on page 134	ACJM-MIV-2
				ACJM-MIV-2S
				ACJS-MIV-3
				ACJS-MIV-3S
				ACJS-MIV-5
		1/4" (6.35mmØ) Jack, Vertical PCB mount, Needle eye contacts, Star washer, Metal nut and insert	Refer to Schematic Chart on page 134	ACJM-MN-2
				ACJS-MN-3
				ACJM-MN-2S
				ACJS-MN-3S
				ACJS-MN-5
		1/4" (6.35mmØ) Jack, Vertical PCB mount, Metal nut and insert	Refer to Schematic Chart on page 134	ACJM-MV-2
				ACJM-MV-2S
				ACJS-MV-3
				ACJS-MV-3S
				ACJS-MV-5

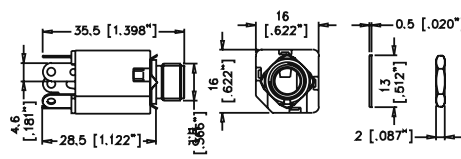
PRODUCT - FIGURE	DRAWING	DESCRIPTION	VARIATIONS	PART NUMBER
	 <p>Dimensions in mm (inches)</p>	1/4" (6.35mm \varnothing) Jack, Solder Lug, Metal nut and insert	Refer to Schematic Chart on Page 110	ACJM-MVS-2
				ACJM-MVS-2S
				ACJS-MVS-3
				ACJS-MVS-3S
				ACJS-MVS-5

PANEL CUTOUTS

-FRONT VIEW

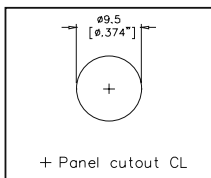

ACJM-MV
ACJS-MV
ACJM-MN-2
ACJS-MN-3
ACJM-MN-2S
ACJS-MN-3S
ACJS-MN-5
ACJM-MIV
ACJS-MIV
ACJM-MVS
ACJS-MVS

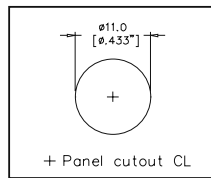

ACJM/S-PH
ACJM/S-MH
ACJM/S-PC
ACJM/S-MC
ACJM/S-PHR
ACJM/S-MHR
ACJM/S-PHS
ACJM/S-MHS

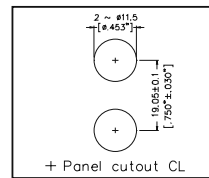

ACJM-MHD
ACJS-MHD
ACJM-MHDE
ACJS-MHDE

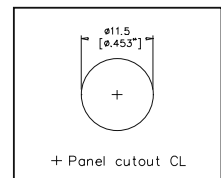

ACJM-MHDR
ACJS-MHDR
ACJS-HHDR

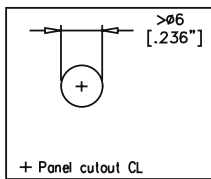

ACJM-NH35
ACJS-NH35

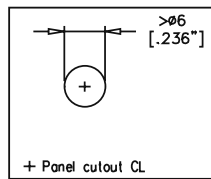

ACJM-NV35-2
ACJM-NV35-2S
ACJM-NV35-3
ACJM-NV35-3S
ACJM-NV35-5
ACJM-NV35-5S
ACJM-MV35-2
ACJM-MV35-2S
ACJM-MV35-3
ACJM-MV35-3S
ACJM-MV35-5
ACJM-MV35-5S

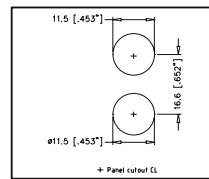

ACJS-MHDC
ACJM-MHDC

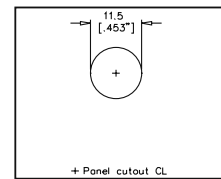

ACJS-IH
ACJM-IH
ACJS-IHS
ACJM-IHS

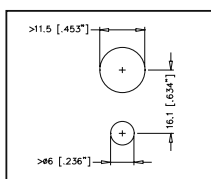

ACJS-MHD985
ACJM-MHD985

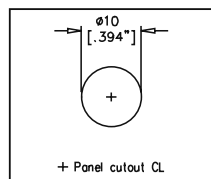

ACJS-MHOM
ACJM-MHOM

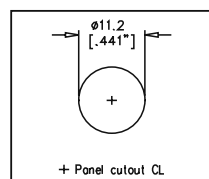

ACJS-MHOP
ACJM-MHOP
ACJS-MHOP-1
ACJM-MHOP-1
ACJS-HHOP-1
ACJM-HHOP-1
ACJS-HHOP

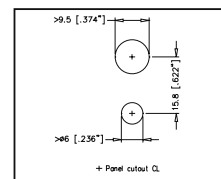

ACJS-MVD985
ACJM-MVD985

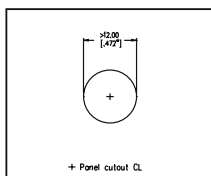

ACJM-PVB-2
ACJM-PVB-2S
ACJS-PVB-3
ACJS-PVB-3S
ACJS-PVB-5

Plugs & Jacks

1/4" / 3.5mm Phone Jack Connectors

SCHEMATIC CHART

PART NO.	ACJM-MV35-2 ACJM-MN-2 ACJM-NV35-2 ACJM-PVB-2 ACJM-MV-2 ACJM-MVS-2 ACJM-MIV-2	ACJM-MV35-2S ACJM-MN-2S ACJM-NV35-2S ACJM-PVB-2S ACJM-MV-2S ACJM-MVS-2S ACJM-MIV-2S	ACJS-MV35-3 ACJS-MN-3 ACJS-NV35-3 ACJS-PVB-3 ACJS-MV-3 ACJS-MVS-3 ACJS-MIV-3	ACJS-MV35-3S ACJS-MN-3S ACJS-NV35-3S ACJS-PVB-3S ACJS-MV-3S ACJS-MVS-3S ACJS-MIV-3S	ACJS-MV35-5 ACJS-MN-5 ACJS-NV35-5 ACJS-PVB-5 ACJS-MV-5 ACJS-MVS-5 ACJS-MIV-5
GENERAL SCHEMATIC					

PART NO.	ACJM-MVD985-2	ACJM-MVD985-2S	ACJS-MVD985-3	ACJS-MVD985-3S	ACJS-MVD985-5	
SCHEMATIC						

PART NO.	ACJM-HHOP-1 ACJM-PHOP-1 ACJM-MHOP-1	ACJS-HHOP-1 ACJS-PHOP-1 ACJS-MHOP-1	ACJM-HHOP ACJM-PHOP ACJM-MHOP	ACJS-HHOP ACJS-PHOP ACJS-MHOP
GENERAL SCHEMATIC				

PCB FOOTPRINT - CONNECTOR SIDE OF PCB

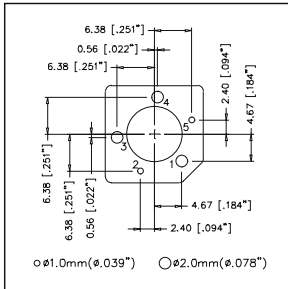

ACJM-MV
ACJS-MV
ACJM-MN-2
ACJS-MN-3
ACJM-MN-2S
ACJS-MN-3S
ACJM-MN-5
ACJS-MN-5
ACJM-NV35-XX
ACJS-NV35-XX
ACJM-MIV-2
ACJS-MIV-2
ACJM-MIV-3
ACJS-MIV-3
ACJM-MIV-5
ACJS-MIV-5

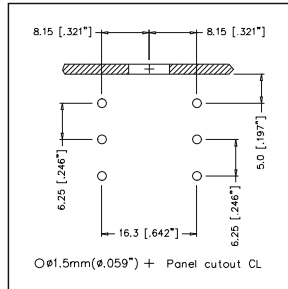

ACJM-PH
ACJM-MH
ACJS-PH
ACJS-MH
ACJM-MH
ACJM-PC
ACJM-MC
ACJS-PC
ACJS-MC

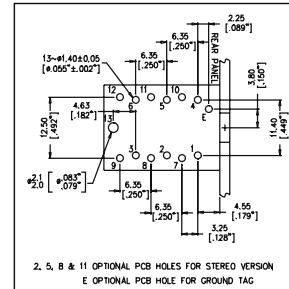

ACJM-MHD
ACJS-MHD
ACJM-MHDE
ACJS-MHDE
ACJM-MHDEM
ACJS-MHDEM
ACJM-MHDC
ACJS-MHDC
ACJM-MHDCM
ACJS-MHDCM
ACJM-MHDM
ACJS-MHDM

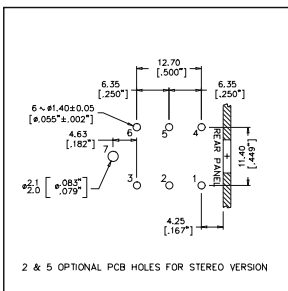

ACJM-MHDR
ACJS-MHDR
ACJM-PHR
ACJM-MHR
ACJS-PHR
ACJS-MHR
ACJM-HHDR
ACJS-HHDR
ACJM-MHDRM
ACJS-MHDRM

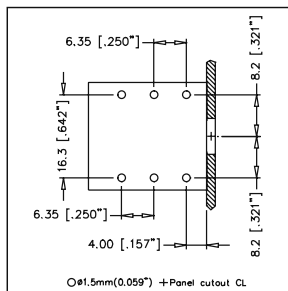

ACJS-IH
ACJM-IH

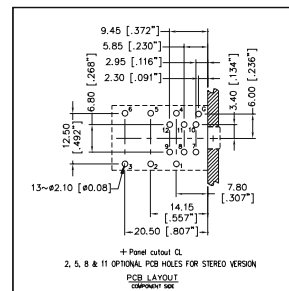

ACJS-MHD985
ACJM-MHD985

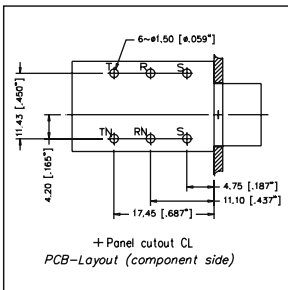

ACJS-MHOM
ACJM-MHOM

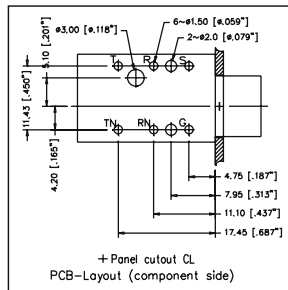

ACJS-MHOP-1
ACJS-PHOP-1
ACJS-HHOP-1
ACJM-MHOP-1
ACJM-PHOP-1
ACJM-HHOP-1

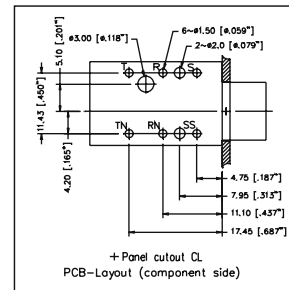

ACJS-MHOP
ACJS-PHOP
ACJM-MHOP
ACJM-PHOP
ACJM-HHOP
ACJS-HHOP

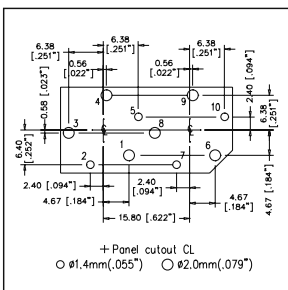

ACJS-MVD985
ACJM-MVD985

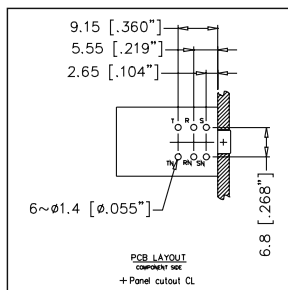

ACJS-NH35
ACJM-NH35

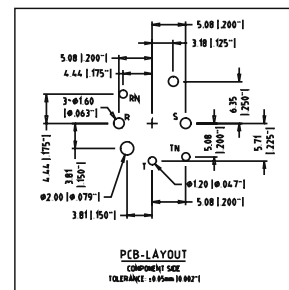

ACJM-PVB-2
ACJM-PVB-2S
ACJS-PVB-3
ACJS-PVB-3S
ACJM-PVB-5

Plugs & Jacks

1/4" / 3.5mm Phone Jack Connectors

1/4" PLUGS TECHNICAL DATA

		VALUE
GENERAL CHARACTERISTICS	Number of Contacts	2 Pole (Mono) 3 Pole Tip Ring Sleeve (Stereo)
	Termination	Solder
	Max. Wire Gauge - Stranded Wire	2 Pole (Mono): AWG 16 ~ 1.5mm ² 3 Pole (Stereo): AWG 18 ~ 1mm ²
	Flammability rating of insulating plastics	UL94V-0
	Solderability, complies with	IEC 68-2-20
	Environmental	Complies with EU RoHS 2 Directive 2011/65/EU
ELECTRICAL CHARACTERISTICS	Current Carrying Capacity	10A (Depends on Mating Connector and Cable)
	Typical Contact Resistance	Depends on Mating Connector
	Insulation resistance (initial) After Damp Heat Test	> 2GΩ ≥ 1GΩ
	Dielectric Withstand Voltage	2 Pole : 1.5 kV dc 3 Pole : 1 kV dc
CLIMATIC CHARACTERISTICS	Protection Class	IP40
	Operating Temperature	-25°C to +70°C (-13°F to 158°F)
MECHANICAL CHARACTERISTICS	Insertion and Withdrawal Force	≥ 10N - ≤ 30N
	Mating Cycles	Min. of 1000 cycles without any physical damage
	Cable O.D. - M Series - M Series II	3mm to 6.5mm (0.118" to 0.256") 6.5mm to 8mm (0.256" to 0.315")
MATERIALS	Connector Shell Material	Diecast Zinc Alloy EZDA No.3
	Connector Shell Finish	Satin Nickel or Black Polyester
	Insulators	UL94 V-0 PBT Resin or Modified PPE Resin and fibreglass laminate
	Cable Bushing	Santoprene
	Contact Plating	Brass / Ni over Cu (Copper)

Rev 4 - 05/2014

¹⁾ Approximate weight only, does not include packaging. Please contact us for exact weight for shipping purposes.

1/4" JACKS TECHNICAL DATA

		VALUE
GENERAL CHARACTERISTICS	Number of Contacts	2 Pole (Mono) 3 Pole Tip Ring Sleeve (Stereo)
	Termination	Solder, PCB or Combo
	Flammability rating of insulating plastics	UL94V-0 or UL94-HB
	Solderability, complies with	IEC 68-2-20
	Environmental	Complies with EU RoHS 2 Directive 2011/65/EU
ELECTRICAL CHARACTERISTICS	Current Carrying Capacity	10A (Depends on Mating Connector and Cable)
	Typical Contact Resistance	≤10mΩ
	Insulation resistance (initial) After Damp Heat Test	>2GΩ ≥10 ³ Meg Ω
	Rated Voltage Test Voltage AC RMS: Dielectric Strength	34V 500V
CLIMATIC CHARACTERISTICS	Protection Class	IP40
	Operating Temperature	-25°C to +70°C (-13°F to 158°F)
MECHANICAL CHARACTERISTICS	Insertion and Withdrawal Force	≥10N - ≤30N
	Mating Cycles	Min. of 10,000 cycles
	Weight - Straight - Right Angle	18g (0.039lb) 25g (0.055lb)
MATERIALS	Connector Housing	Nylon PA66 30% Glass Filled
	Metal Nut	Brass
	Plastic Nut	Nylon PA66 30% Glass Filled
	Washer	Fiber / Brass / Nylon PA66 30% Glass Filled
	Contact Plating	Tin - 4μm Min. over 2μm Min.Cu (Copper) Silver - 0.3μm Min. over 2μm Min.Cu (Copper) Nickel - 2μm Min. over 2μm Min.Cu (Copper) Gold Flash - 0.05μm Min. over 2μm Min.Cu (Copper)
	Contacts	Brass / Sn (Tin) over Cu (Copper)

Rev 7 - 04/2023

¹Approximate weight only, does not include packaging. Please contact us for exact weight for shipping purposes.

Plugs & Jacks

K Series Plugs (3.5mm)



K SERIES PLUGS (3.5MM)

Features:

- Mono or TRS (Stereo).
- AX Series inspired shell design.
- Suits Cable O.D from 2.5mm to 5mm (0.098" to 0.196")
- Robust diecast shell in Satin nickel or Black finish.
- Nickel or Gold contact plating.
- Flexible grommet cable protection.
- Improved solderability.
- Precision machined contacts.
- Standard or Bulk packaging.

Options: Black Shell, Gold contacts.

PRODUCT - FIGURE	DRAWING	Dimensions in mm (inches)	DESCRIPTION	VARIATIONS	PART NUMBER
		49 [1.911"] 35 [1.370"] ø10.3 [ø.406"]	3.5mm, Mono Phone plug, Diecast Shell, Satin finish, Flexible grommet.	Standard Gold Plated Contacts Bulk Pack	KM2P KM2P-AU KM2P BULK
		49 [1.911"] 35 [1.370"] ø10.3 [ø.406"]	3.5mm, Mono Phone plug, Diecast Shell, Black finish, Flexible grommet.	Standard Gold Plated Contacts Bulk Pack	KM2PB KM2PB-AU KM2PB BULK
		49 [1.911"] 35 [1.370"] ø10.3 [ø.406"]	3.5mm, Stereo Phone plug, Diecast Shell, Satin finish, Flexible grommet.	Standard Gold Plated Contacts Bulk Pack	KS3P KS3P-AU KS3P BULK
		49 [1.911"] 35 [1.370"] ø10.3 [ø.406"]	3.5mm, Stereo Phone plug, Diecast Shell, Black finish, Flexible grommet.	Standard Gold Plated Contacts Bulk Pack	KS3PB KS3PB-AU KS3PB BULK
		51 [2.008"] 37 [1.467"] 3.10 [1.22"] ø10.3 [ø.406"]	3.5mm, Stereo Phone plug with extended shaft for mobile phones fitted with covers. Diecast Shell, Black Chrome finish, Flexible grommet	Standard Gold Plated Contacts	KS3PC KS3PC-AU

Plugs & Jacks

K Series Plugs (3.5mm)

PART NUMBER BREAKDOWN

K-SERIES

E. G. **KS3P-AU BULK**
K (Series Prefix), **S3**(Stereo), Plug,
AU (Gold Plated Contacts), **Bulk** Packaged.

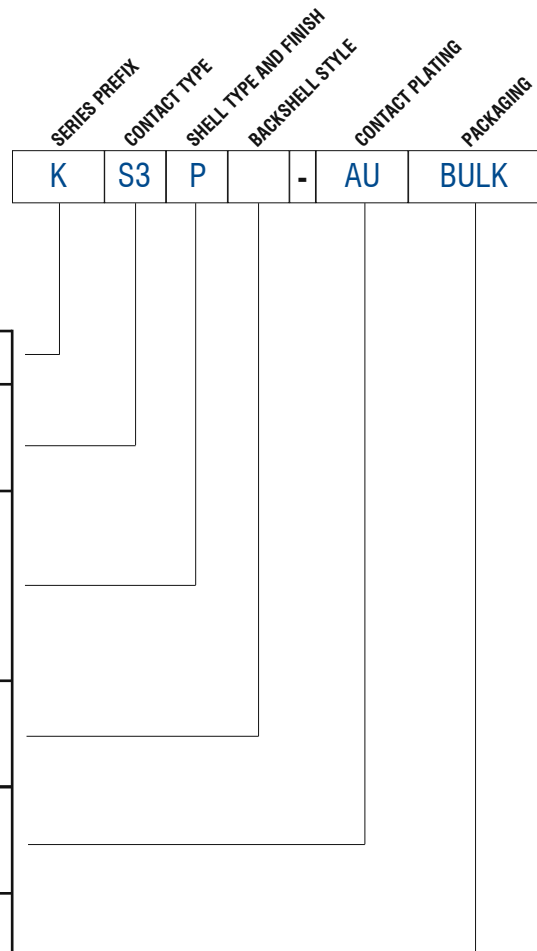

SERIES PREFIX	K	=	Series Prefix
CONTACT TYPE	M2	=	2 Pole (mono)
	S3	=	3 pole TRS (Stereo)
SHELL TYPE AND FINISH	P	=	Plug Satin Nickel
	PB	=	Plug Matt Black
	PC	=	Plug Black Chrome
BACKSHELL TYPE AND CABLE CLAMP	Blank	=	K Series to suit Cable O.D 2.5mm to 5mm (0.098" to 0.196")
CONTACT PLATING	Blank	=	Nickel Plated Contacts (Standard)
	AU	=	Gold Plated Contacts
PACKAGING	Blank	=	Individual Bags
	BULK	=	Bulk Packed

ISO VIEW OF KS3P

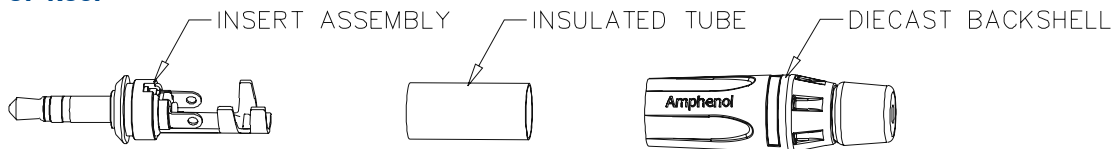

3.5mm PLUG TECHNICAL DATA

		VALUE
GENERAL CHARACTERISTICS	Number of Contacts	2 Pole (Mono) 3 Pole Tip Ring Sleeve (Stereo)
	Termination	Solder
	Wire Gauge - Stranded Wire	2 Pole (Mono): AWG 16 - 1.5mm ² 3 Pole (Stereo): AWG 18 - 1mm ²
	Flammability rating of insulating plastics	UL94V-0
	Solderability, complies with	IEC 68-2-20
	Environmental	Complies with EU RoHS 2 Directive 2011/65/EU
ELECTRICAL CHARACTERISTICS	Current Carrying Capacity	>0.5mA (Depends on Mating Connector and Cable)
	Typical Contact Resistance	≤20mΩ (Depends on Mating Connector and Cable)
	Insulation resistance (initial) After Damp Heat Test	>200M Ω >100M Ω
	Test Voltage AC RMS: Dielectric Strength	250VAC
CLIMATIC CHARACTERISTICS	Protection Class	IP40
	Operating Temperature	-20°C to +65°C (-4°F to +149°F)
MECHANICAL CHARACTERISTICS	Insertion and Withdrawal Force	<20N / >3N (depends on mating connector)
	Cable O.D.	3mm to 5mm (0.118" to 0.196")
	Mechanical Operations	1000 mating cycles
	Weight	8g (0.017lb)
MATERIALS	Connector Shell Material (Plugs)	Diecast Zinc Alloy EZDA No.3
	Connector Shell Finish	Satin Nickel or Black Polyester
	Insulators	PA66
	Cable Bushing	Santoprene
	Contacts	Brass
	Plating	Nickel or Gold Flash

¹ Approximate weight only, does not include packaging. Please contact us for exact weight for shipping purposes.



PLUGS AND SOCKETS

Amphenol's plugs and sockets range continually expands to meet the needs of our customers. The success of the M-Series phone plugs led to the RCA series being developed. The Miniature XLR range was a natural progression from our standard XLR series as demand for smaller interconnects increased. The latest addition to the range is a professional grade 3.5mm phone plug designed for applications that require a robust interconnect.

Applications

- Audio Cables and Snakes
- Amplifiers
- Speakers
- Mixing desks
- Rack mount equipment
- Patch panel

Features / Options – RCA Plugs and Jacks

- Red, Black, White, Yellow, Blue or Green shell colours
- Stylish shell design
- Flexible grommet cable protection
- Gold Plated Contacts

Features / Options – Miniature XLR

- 3,4,5, or 6 contacts
- Solder cup
- Printed Circuit Board
- Vertical or Horizontal mounting
- Positive locking latch
- Flexible cable clamp
- Metal cable clamp
- Locking rings
- Chassis front mount
- Chassis middle or rear mount (on request)
- Optional black finish (on request)

Features / Options – 3.5mm Plugs Phone Jack

- Mono / Stereo TRS
- Solder contacts
- Suits cable O.D 2.5mm to 5mm
- Stylised shell design
- Flexible cable grommet
- Metal cable clamp
- Nickel or Gold contact plating
- Satin Nickel or Black finish

Cable Clamp Options

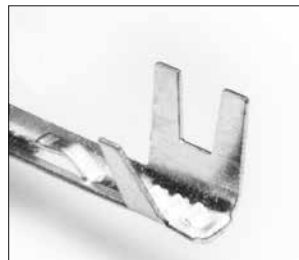

RCA Cable Clamp - M-Series, Cable O.D 3mm to 6.5mm (0.118" to 0.256")

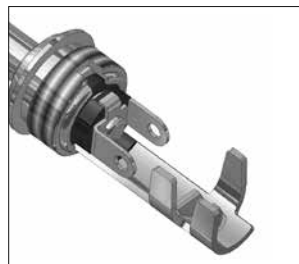

K-Series, Cable O.D 3mm to 5mm (0.118" to 0.196")

Ordering Codes

We have listed the more common ordering codes in each section. Please contact us if you need any further assistance.

Simple steps to guide you in using this catalogue

- 1) Identify the product group listed in Contents on page 1 and go directly to that page number.
- 2) Each product group cover page then details information and options available.
- 3) Refer to the product detail pages and identify the product you require pictorially.
- 4) Read the product description column for the products standard features.
- 5) Use variations column to determine your choice.
- 6) Identify part number.
- 7) In the event the particular option you require is not listed please refer to the part number breakdown page at the end of each section.
- 8) Please contact us directly if you have any further problems.

Plugs & Sockets

RCA Series









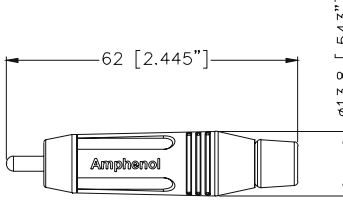

RCA SERIES

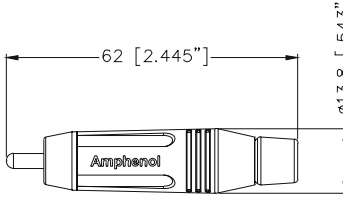
Features:

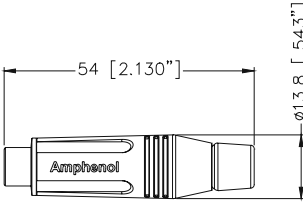
- Stylish design
- Flexible grommet cable protection
- Robust diecast shell
- Gold plated contacts
- Colour coded
- Good solderability
- Quick and easy assembly
- Panel mount utilises standard 'D' type housing

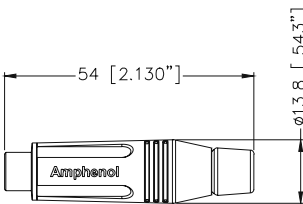
Part Number Breakdown: Page 143

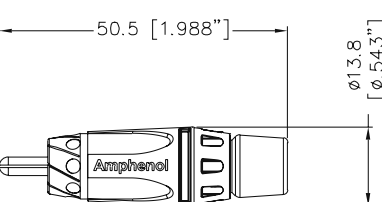
PRODUCT - FIGURE	DRAWING	Dimensions in mm (inches)	DESCRIPTION	VARIATIONS	PART NUMBER
		62 [2.445"] ø13.8 [.543"]	RCA Plug, Diecast Shell, Gold plated contacts, Coloured finish, Flexible coloured grommet	Red Black Yellow White Blue Green	ACPR-RED ACPR-BLK ACPR-YEL ACPR-WHT ACPR-BLU ACPR-GRN
		62 [2.445"] ø13.8 [.543"]	RCA Plug, Diecast Shell, Gold plated contacts, Satin finish, Flexible coloured grommet	Satin / Red Satin / Black Satin / Yellow Satin / White Satin / Blue Satin / Green	ACPR-SRD ACPR-SBK ACPR-SYL ACPR-SWH ACPR-SBL ACPR-SGR
		54 [2.130"] ø13.8 [.543"]	RCA Jack, Diecast Shell, Gold plated contacts, Coloured finish, Flexible coloured grommet	Red Black Yellow White Blue Green	ACJR-RED ACJR-BLK ACJR-YEL ACJR-WHT ACJR-BLU ACJR-GRN
		54 [2.130"] ø13.8 [.543"]	RCA Jack, Diecast Shell, Gold plated contacts, Satin finish, Flexible coloured grommet	Satin / Red Satin / Black Satin / Yellow Satin / White Satin / Blue Satin / Green	ACJR-SRD ACJR-SBK ACJR-SYL ACJR-SWH ACJR-SBL ACJR-SGR
		50.5 [1.988"] ø13.8 [ø.543"]	RCA Plug, Shortened Diecast Shell, Gold plated contacts, Black Chrome finish, Flexible coloured grommet	Red Black Yellow White Blue Green	ACPL-CRD ACPL-CBK ACPL-CYL ACPL-CWH ACPL-CBL ACPL-CGR

NOTE: RCA Series comply with EU RoHS 2 Directive 2011/65/EU

PRODUCT - FIGURE	DRAWING	Dimensions in mm (inches)	DESCRIPTION	VARIATIONS	PART NUMBER
			RCA Jack, Diecast Shell, Gold plated contacts, Nickel finish shell, coloured insulator.	Red Black Yellow White Blue Green	ACJD-RED ACJD-BLK ACJD-YEL ACJD-WHT ACJD-BLU ACJD-GRN

NOTE: RCA Series comply with EU RoHS 2 Directive 2011/65/EU

PART NUMBER BREAKDOWN

M SERIES RCA

E. G. **ACPR-RED BULK**
AC (Series Prefix), **P** (Plug), **R** (Shell type), **RED** (Shell and Grommet Colour),
Bulk Packaged.

SERIES PREFIX	CONTACT TYPE	SHELL TYPE	SHELL FINISH	PACKAGING	
AC	P	R	-	RED	BULK

SERIES PREFIX	AC	=	Series Prefix
CONTACT TYPE	J	=	RCA Female Jack
	P	=	RCA Male Plug
SHELL TYPE	R	=	Regular Shell Length
	L	=	Short Shell Length
	D	=	Chassis Jack 'D' Shell
SHELL AND GROMMET COLOUR	RED	=	Red, Red Grommet
	BLK	=	Black, Black Grommet
	YEL	=	Yellow, Yellow Grommet
	WHT	=	White, White Grommet
	BLU	=	Blue, Blue Grommet
	GRN	=	Green, Green Grommet
	SRD	=	Satin Nickel, Red Grommet
	CRD	=	Black Chrome, Red Grommet
	SBK	=	Satin Nickel, Black Grommet
	CBK	=	Black Chrome, Black Grommet
	SYL	=	Satin Nickel, Yellow Grommet
	CYL	=	Black Chrome, Yellow Grommet
	SWH	=	Satin Nickel, White Grommet
	CWH	=	Black Chrome, White Grommet
	SBL	=	Satin Nickel, Blue Grommet
	CBL	=	Black Chrome, Blue Grommet
	SGR	=	Satin Nickel, Green Grommet
	CGR	=	Black Chrome, Green Grommet
	NOTE: Denotes colour of insulator only on shell type D, Chassis Jack 'D' Shell. Shell finish is Nickel.		
PACKAGING	Blank	=	Individual Bags
	BULK	=	Bulk Packed

RCA TECHNICAL DATA

		VALUE	
GENERAL CHARACTERISTICS	Number of Contacts	2	
	Termination	Solder	
	Max. Wire Gauge - Stranded Wire	AWG 14 - 2.5mm ²	
	Flammability rating of insulating plastics	UL94V-0	
	Solderability, complies with	IEC 68-2-20	
	Environmental	Complies with EU RoHS 2 Directive 2011/65/EU	
ELECTRICAL CHARACTERISTICS	Current Carrying Capacity	10A (Depends on Mating Connector)	
	Typical Contact Resistance	≤10mΩ (Depends on Mating Connector)	
	Insulation resistance (initial) After Damp Heat Test	>2GΩ ≥ 10 ³ Meg Ω	
	Dielectric Strength	1500 V dc	
CLIMATIC CHARACTERISTICS	Protection Class	IP40	
	Operating Temperature	-25°C to +75°C (-13°F to +167°F)	
MECHANICAL CHARACTERISTICS	Insertion and Withdrawal Force	≥10N - ≤30N (depends on mating connector)	
	Cable O.D.	ACPL with grommet without grommet	3mm to 6.5mm (0.118" to 0.255") 3mm to 8.5mm (0.118" to 0.334")
		ACPR with grommet without grommet	3mm to 7mm (0.118" to 0.275") 3mm to 8.5mm (0.118" to 0.334")
	Mechanical Operations	500 mating cycles	
	Weight - Cable Mount - Panel Mount	18g (0.039lb) 30g (0.066lb)	
MATERIALS	Connector Shell Material (Plugs)	Diecast Zinc Alloy EZDA No.3	
	Connector Shell Finish	Satin Nickel or Coloured Polyester	
	Insulators	PA66	
	Cable Bushing	Thermoplastic Polyurethane	
	Contacts	Brass Alloy	
	Plating	Gold Flash	

Rev 5 - 10/2024

¹⁾Approximate weight only, does not include packaging. Please contact us for exact weight for shipping purposes.



MULTIPIN CONNECTORS

Amphenol has an extensive range of circular and rectangular multi-pin connectors ideally suited to the entertainment industry. Featuring rugged housings and precision made contacts these connectors have proven themselves in the most demanding of applications. The extensive arrangement of different connector sizes and contact numbers ensure we can offer a solution to your multi-pin wiring applications.

Applications

- Audio Cables and Snakes
- Lighting control
- Concert Touring Systems
- Outside Broadcast Systems

Features / Options - MP-41 Series

- 13 to 85 pins with Crimp / Solder bucket contacts
- 150 pins with Crimp contacts only
- 4 to 48 channel
- Gold plated contacts
- Synthetic inserts
- Environmental resistant
- Positive Bayonet locking
- PG cable gland
- 2000 mating cycles
- Bayonet wear pins
- Extended coupling ring
- Metal Housings

Features / Options - MP-62 Series

- 39 or 61 Solder bucket contacts
- Gold plated contacts
- Neoprene inserts
- Environmental resistant
- Positive Bayonet locking
- PG cable gland or NPT thread
- Metal Housings

Ordering Codes

We have listed the more common ordering codes in each section. For further options please contact us.

Simple steps to guide you in using this catalogue

- 1) Identify the product group listed in Contents on page 1 and go directly to that page number.
- 2) Each product group cover page then details information and options available.
- 3) Refer to the product detail pages and identify the product you require pictorially.
- 4) Read the product description column for the products standard features.
- 5) Use pins column to determine number of contacts.
- 6) Identify part number.
- 7) In the event the particular option you require is not listed please refer to the part number breakdown page at the end of each section.
- 8) Please contact us directly if you have any further problems.

Multipin Connectors

MP-41 Series



MP-41 SERIES

Amphenol's MP-41 series of multipin connectors utilise the same design principals of the rugged Mil-C-5015 military connectors. They can withstand high shock and vibration environments and are ideal for tough on-road applications. Featuring a quick mating bayonet coupling with an audible full mating feature ensures a positive connection every time. Available from 13 to 150 pins with contacts supplied with each connector as standard.

Features:



- 13 to 85 pins with Crimp/Solder bucket contacts
- 150 pins with Crimp contacts only
- 4 to 48 channels
- Gold plated contacts
- Synthetic insert
- Protective dust caps
- Industry standard compatible
- 2000 mating cycles
- Black finish
- Positive bayonet locking
- PG cable glands
- IP67 rated
- Metal housings

Options: NPT threaded backshells.

Crimp Tooling: Page 149

Specifications: Page 150 **Part Number Breakdown:** Page 149

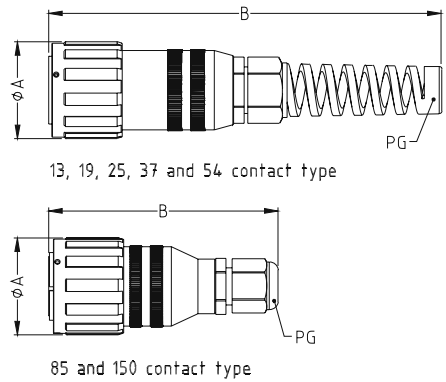

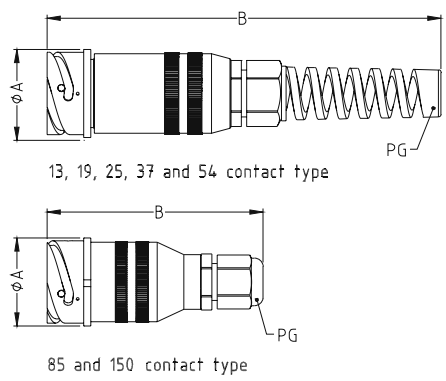
Wiring Information: Page 141

PRODUCT - FIGURE	Dimensions in mm (inches) DRAWING	Dimensions in mm (inches)			PINS	PART NUMBER	PART NUMBER With Dustcap
		A	B	PG			
 <p>Straight cable plug with socket contacts, Black finish, supplied complete with contacts.</p> <p>13, 19, 25, 37 and 54 contact type</p> <p>85 and 150 contact type</p>		40.5 (1.60)	160 (6.30)	11	13	MP-4106-13S	MP-4106-13S-C
		44 (1.73)	171 (6.73)	13.5	19	MP-4106-19S	MP-4106-19S-C
		46.6 (1.83)	193 (7.60)	16	25	MP-4106-25S	MP-4106-25S-C
		54.3 (2.14)	210 (8.26)	21	37	MP-4106-37S	MP-4106-37S-C
		60.1 (2.36)	210 (8.26)	21	54	MP-4106-54S	MP-4106-54S-C
		73.3 (2.88)	137 (5.40)	29	85	MP-4106-85S	MP-4106-85S-C
		73.3 (2.88)	145 (5.70)	36	150	MP-4106-150S	MP-4106-150S-C
		 <p>Cable connecting receptacle with pin contacts, black finish, supplied complete with contacts.</p> <p>13, 19, 25, 37 and 54 contact type</p> <p>85 and 150 contact type</p>		37.8 (1.49)	160 (6.30)	11	13
41.1 (1.62)	171 (6.73)			13.5	19	MP-4101-19P	MP-4101-19P-C
41.5 (1.63)	193 (7.60)			16	25	MP-4101-25P	MP-4101-25P-C
51 (2.00)	210 (8.26)			21	37	MP-4101-37P	MP-4101-37P-C
57.1 (2.25)	210 (8.26)			21	54	MP-4101-54P	MP-4101-54P-C
70 (2.75)	137 (5.40)			29	85	MP-4101-85P	MP-4101-85P-C
70 (2.75)	145 (5.70)			36	150	MP-4101-150P	MP-4101-150P-C

Note: NPT threaded backshells available on request. Please contact us.

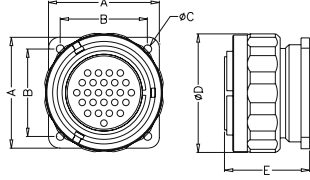

Multipin Connectors

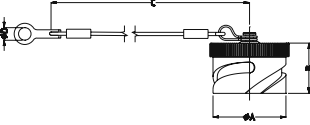
MP-41 Series

PRODUCT - FIGURE	Dimensions in mm (inches) DRAWING	Dimensions in mm (inches)						PINS	PART NUMBER	PART NUMBER With Dustcap
		A	B	C	D	E	F			
 	Panel plug with socket contacts, black finish, supplied complete with contacts.	38 (1.49)	29.4 (1.15)	3.2 (0.13)	40.5 (1.60)	38.8 (1.53)	N/A	13	MP-4164-13S	MP-4164-13S-C
		41 (1.61)	31.8 (1.25)	3.2 (0.13)	44 (1.73)	38.8 (1.53)	N/A	19	MP-4164-19S	MP-4164-19S-C
		44.5 (1.75)	34.9 (1.37)	3.73 (0.14)	48.51 (1.91)	40.6 (1.60)	N/A	25	MP-4164-25S	MP-4164-25S-C
		50.8 (1.99)	39.7 (1.56)	3.73 (0.14)	54.3 (2.14)	42 (1.65)	N/A	37	MP-4164-37S	MP-4164-37S-C
		57 (2.24)	44.5 (1.75)	4.39 (0.17)	60.8 (2.40)	45 (1.77)	N/A	54	MP-4164-54S	MP-4164-54S-C
		69.8 (2.74)	55.5 (2.18)	4.39 (0.17)	73.3 (2.88)	45 (1.77)	N/A	85	MP-4164-85S	MP-4164-85S-C
		69.8 (2.74)	55.5 (2.18)	4.39 (0.17)	73.3 (2.88)	45 (1.77)	N/A	150	MP-4164-150S	MP-4164-150S-C
		38 (1.49)	29.4 (1.15)	3.23 (0.13)	34.2 (1.34)	34.5 (1.35)	29 (1.14)	13	MP-4102-13P	MP-4102-13P-C
		41 (1.61)	31.8 (1.25)	3.23 (0.13)	37.4 (1.47)	34.5 (1.35)	32.2 (1.26)	19	MP-4102-19P	MP-4102-19P-C
		44.5 (1.75)	34.9 (1.37)	3.73 (0.14)	40.9 (1.61)	35.7 (1.40)	35.3 (1.38)	25	MP-4102-25P	MP-4102-25P-C
50.8 (1.99)	39.7 (1.56)	3.73 (0.14)	46.7 (1.83)	36.5 (1.44)	41.4 (1.62)	37	MP-4102-37P	MP-4102-37P-C		
57 (2.24)	44.5 (1.75)	4.30 (0.17)	53.4 (2.10)	38.5 (1.52)	47.8 (1.88)	54	MP-4102-54P	MP-4102-54P-C		
69.8 (2.74)	55.5 (2.18)	4.30 (0.17)	65.5 (2.57)	38.5 (1.52)	59 (2.32)	85	MP-4102-85P	MP-4102-85P-C		
69.8 (2.74)	55.5 (2.18)	4.30 (0.17)	65.5 (2.57)	38.5 (1.52)	59 (2.32)	150	MP-4102-150P	MP-4102-150P-C		
 	Plug protective dustcap to suit MP-4164 type.	34.16 (1.35)	31.5 (1.24)	110 (4.33)	4.7 (0.18)	-	-	13	MP-25042-13S	-
		37.36 (1.47)	31.5 (1.24)	110 (4.33)	4.7 (0.18)	-	-	19	MP-25042-19S	-
		40.87 (1.61)	31.5 (1.24)	110 (4.33)	4.7 (0.18)	-	-	25	MP-25042-25S	-
		46.68 (1.84)	31.5 (1.24)	110 (4.33)	4.7 (0.18)	-	-	37	MP-25042-37S	-
		53.36 (2.10)	31.5 (1.24)	110 (4.33)	5.5 (0.22)	-	-	54	MP-25042-54S	-
		65.48 (2.58)	31.5 (1.24)	110 (4.33)	5.5 (0.22)	-	-	85	MP-25042-85S	-
		65.48 (2.58)	31.5 (1.24)	110 (4.33)	5.5 (0.22)	-	-	150	MP-25042-150S	-
		38.8 (1.53)	20.7 (0.81)	255 (8.07)	-	-	-	13	MP-25042-13L	-
41.6 (1.64)	20.7 (0.81)	255 (8.07)	-	-	-	19	MP-25042-19L	-		
45.3 (1.78)	20.7 (0.81)	255 (8.07)	-	-	-	25	MP-25042-25L	-		
52.15 (2.05)	20.7 (0.81)	255 (8.07)	-	-	-	37	MP-25042-37L	-		
58.6 (2.30)	20.7 (0.81)	255 (8.07)	-	-	-	54	MP-25042-54L	-		
70.7 (2.78)	20.7 (0.81)	255 (8.07)	-	-	-	85	MP-25042-85L	-		
70.7 (2.78)	20.7 (0.81)	255 (8.07)	-	-	-	150	MP-25042-150L	-		

Multipin Connectors

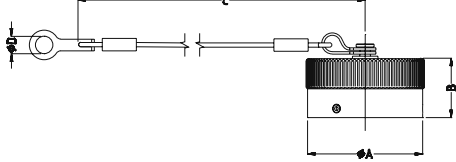
MP-41 Series

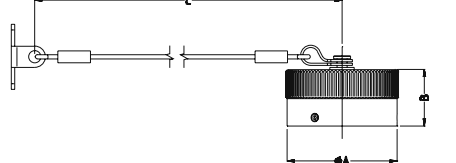
PRODUCT - FIGURE	Dimensions in mm (inches) DRAWING	Dimensions in mm (inches)						PINS	PART NUMBER
		A	B	C	D	E	F		
	<p>Plug protective dustcap to suit MP-4102 types.</p> 	34.16 (1.35)	31.5 (1.24)	110 (4.33)	4.7 (0.18)	-	-	13	MP-25043-13S
		37.36 (1.47)	31.5 (1.24)	110 (4.33)	4.7 (0.18)	-	-	19	MP-25043-19S
		40.87 (1.61)	31.5 (1.24)	110 (4.33)	4.7 (0.18)	-	-	25	MP-25043-25S
		46.68 (1.84)	31.5 (1.24)	110 (4.33)	4.7 (0.18)	-	-	37	MP-25043-37S
		53.36 (2.10)	31.5 (1.24)	110 (4.33)	5.5 (0.22)	-	-	54	MP-25043-54S
		65.48 (2.58)	31.5 (1.24)	110 (4.33)	5.5 (0.22)	-	-	85	MP-25043-85S
		65.48 (2.58)	31.5 (1.24)	110 (4.33)	5.5 (0.22)	-	-	150	MP-25043-150S
			<p>Receptacle protective dustcap to suit MP-4101 types.</p> 	38.8 (1.53)	20.7 (0.81)	255 (8.07)	-	-	-
41.6 (1.64)	20.7 (0.81)			255 (8.07)	-	-	-	19	MP-25043-19L
45.3 (1.78)	20.7 (0.81)			255 (8.07)	-	-	-	25	MP-25043-25L
52.15 (2.05)	20.7 (0.81)			255 (8.07)	-	-	-	37	MP-25043-37L
58.6 (2.30)	20.7 (0.81)			255 (8.07)	-	-	-	54	MP-25043-54L
70.7 (2.78)	20.7 (0.81)			255 (8.07)	-	-	-	85	MP-25043-85L
70.7 (2.78)	20.7 (0.81)			255 (8.07)	-	-	-	150	MP-25043-150L

Multipin Connectors

MP-41 Series

PRODUCT - FIGURE	DRAWING	DESCRIPTION	NO. OF PINS	PART NUMBER
	N/A	Crimp Tool	All	M22520/1-01
	N/A	Positioner / Turret	All	TH29-1
	N/A	Insertion tool	13-85	MP-INS-16
			150	MP-INS-18
	N/A	Extraction tool	All	MP-EXT-16/18
	N/A	Contact Pilot Pin	13-85	MP-GUIDE-16
			150	MP-GUIDE-18
	N/A	Solder/Crimp Pin Contact	13-85 (Size 16)	MP-108400
		Crimp Pin Contact (Soldering of this contact is not recommended)	150 (Size 18)	MP-108300
	N/A	Solder/Crimp Socket Contact	13-85 (Size 16)	MP-108600
		Crimp Socket Contact (Soldering of this contact is not recommended)	150 (Size 18)	MP-108500

NOTE: Complete instructions for providing reliable crimped wire to contact terminations and inserting proprietary contacts in MP-41 Series connectors are available in publication PI523 located on our website www.amphenolaudio.com.

PART NUMBER BREAKDOWN MP-41 SERIES

MULTIPIN CIRCULAR CONNECTORS

E. G. **MP-4106-85S**
Multipin, **4106** Cable Plug, **85** Contacts, **S** Female Socket Contacts,

SERIES PREFIX	MP	=	Series Prefix
HOUSING TYPE	4101	=	Inline cable connecting receptacle
	4102	=	Panel receptacle
	4106	=	Cable plug
	4164	=	Panel plug
	25042S	=	Dustcap for panel plug
	25042L	=	Dustcap for cable plug
	25043S	=	Dustcap for panel receptacle
	25043L	=	Dustcap for cable receptacle
NO. OF CONTACTS			13, 19, 25, 37, 54, 85, 150
GENDER <small>*Not required for dustcap part numbers</small>	P	=	Male pin contacts
	S	=	Female socket contacts
OPTIONS	C	=	Supplied with Dustcap

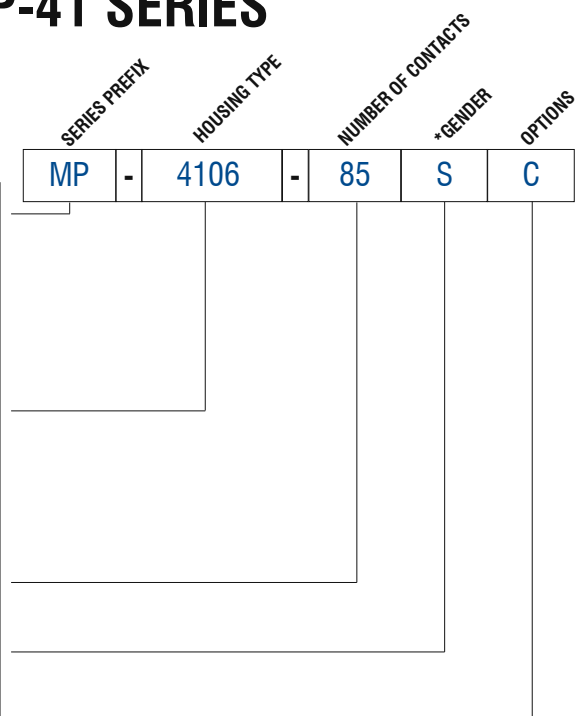

Multipin Connectors

MP-41 Series

STANDARD DATA MP-41 SERIES

		VALUE						
GENERAL CHARACTERISTICS	Number of contacts	13	19	25	37	54	85	150
	Number of channels	4	6	8	12	16	28	48
	Termination	Solder / Crimp "Combo"						Crimp
	Wire Gauge - Stranded Wire	16AWG - 20AWG						18AWG
	Environmental	Complies with EU RoHS 2 Directive 2011/65/EU						
ELECTRICAL CHARACTERISTICS	Operating Voltage at Sea level - DC	250V*						250V*
	Operating Voltage at Sea level - AC	200V*						200V*
	Test Voltage AC RMS	1000V						1000V
	Current Carrying Capacity	13A						7.5A
	Typical Contact Resistance	3.46mΩ						11.25mΩ
	Insulation Resistance	5000MΩ						
CLIMATIC CHARACTERISTICS	Protection Class	IP67 (when mated)						
	Operating Temperature	-55°C to +125°C (-67°F to +257°F)						
MECHANICAL CHARACTERISTICS	Cable Retention	PG Gland						
	Mechanical Operations	2000 mating cycles						
MATERIALS	Connector / Shell Finish	Aluminium Alloy / Black						
	Insert	Synthetic Insert to MIL-R-3065						
	Male pin contact / Plating	Brass / Gold plated						
	Female socket contact / Plating	Brass / Gold plated						
CLAMPING CHARACTERISTICS	PG Gland	11	13.5	16	21	29	36	
	Cable Clamping range	mm	4-10	5-12	9-14	13-18	14-25	19-32
	(inches)	(0.15"-0.39")	(0.19"-0.47")	(0.35"-0.55")	(0.51"-0.70")	(0.55"-0.98")	(0.74"-1.25")	

*Not suitable for domestic applications above 50V

Rev 2 - 03/2013













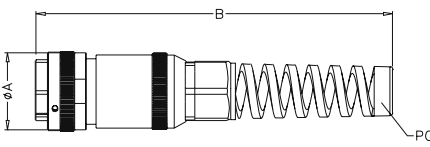

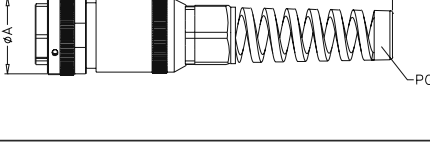
MP-62/65 SERIES

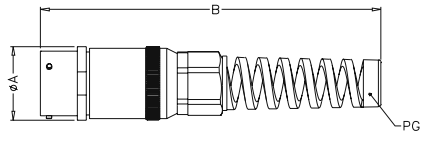
Amphenol's Multipin MP-62 series of circular connectors utilise the same design principles as the Mil-C-26482 military connectors. Featuring a three point quick mating bayonet coupling and five key polarisation ensuring a positive connection every time. Available in two contact pin layouts 39 and 61 with gold plated solder contacts fitted as standard.

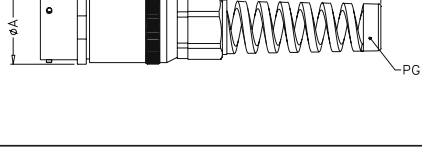
Features:

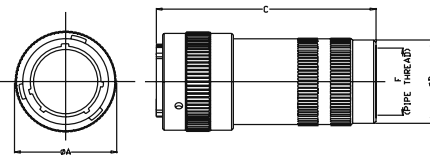
- 39 or 61 pins.
- Gold plated solder contacts.
- Neoprene insert.
- Protective dust caps
- Metal housings
- Environmental resistant.
- Black finish.
- Positive bayonet locking
- PG cable glands

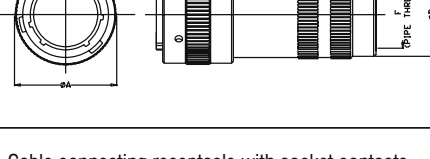
Specifications: Page 153 Wiring Info: Page 141

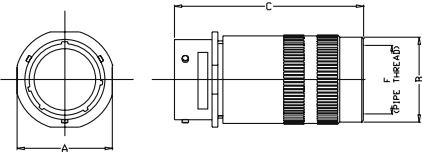
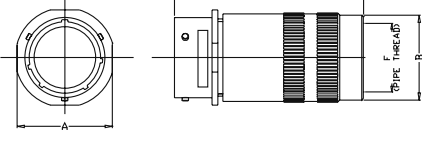
PRODUCT - FIGURE	Dimensions in mm (inches) DRAWING	Dimensions in mm (inches)			PINS	PART NUMBER	PART NUMBER With Dustcap
		A	B	PG			
	Straight cable plug with pin contacts, Black finish, Gold plated solder contacts. 	38.9	181.5	16	39	MP-6216-39P	MP-6216-39P-C
		(1.53)	(7.15)				
		45.5	193	21	61	MP-6216-61P	MP-6216-61P-C
		(1.80)	(7.60)				
	Cable connecting receptacle with socket contacts, Black finish, Gold plated solder contacts. 	36.7	181.5	16	39	MP-6211-39S	MP-6211-39S-C
		(1.45)	(7.15)				
		43.0	193	21	61	MP-6211-61S	MP-6211-61S-C
		(1.70)	(7.60)				
	Straight cable plug with pin contacts, NPT 3/4" threaded backshell, Black finish, Gold plated solder contacts. 	38.9	90	NPT	39	MP-6516-39P	MP-6516-39P-C
		(1.53)	(3.54)	3/4"			
		45.5	100	NPT	61	MP-6516-61P	MP-6516-61P-C
		(1.80)	(3.94)	3/4"			
	Cable connecting receptacle with socket contacts, NPT 3/4" threaded backshell, Black finish, Gold plated solder contacts. 	36.7	90	NPT	39	MP-6511-39S	MP-6511-39S-C
		(1.45)	(3.54)	3/4"			
		43.0	100	NPT	61	MP-6511-61S	MP-6511-61S-C
		(1.70)	(3.94)	3/4"			

Multipin Connectors

MP-62/65 Series

PRODUCT - FIGURE	DRAWING Dimensions in mm (inches)	Dimensions in mm (inches)						PINS	PART NUMBER	PART NUMBER With Dustcap
		A	B	C	D	E	F			
	<p>Panel plug with pin contacts, Black finish, Gold plated solder contacts.</p>	38.86	29.36	6-32	39.0	32	-	39	MP-6256-39P	MP-6256-39P-C
		(1.53)	(1.16)	UNC	(1.54)	(1.26)	-			
	<p>Panel receptacle plug with socket contacts, Black finish, Gold plated solder contacts.</p>	43.94	34.93	6-32	45.5	35	-	61	MP-6256-61P	MP-6256-61P-C
		(1.73)	(1.38)	UNC	(1.80)	(1.38)	-			
	<p>Panel receptacle plug with socket contacts, Black finish, Gold plated solder contacts.</p>	36.7	29.36	3.05	31.8	22.3	30.1	39	MP-6212-39S	MP-6212-39S-C
		(1.44)	(1.15)	(0.12)	(1.25)	(0.87)	(1.18)			
	<p>Panel receptacle plug with socket contacts, Black finish, Gold plated solder contacts.</p>	43.0	34.93	3.74	38.1	22.3	36.4	61	MP-6212-61S	MP-6212-61S-C
		(1.69)	(1.38)	(0.15)	(1.50)	(0.87)	(1.43)			

PRODUCT - FIGURE	DRAWING Dimensions in mm (inches)	DESCRIPTION	Dimensions in mm (inches)				PINS	PART NUMBER
			A	B	C	D		
	<p>Plug protective dustcap to suit MP-6256</p>		31.7	15.9	127	4.40	39	MP-742-39S
			(1.25)	(0.62)	(4.99)	(0.17)		
	<p>Plug protective dustcap to suit MP-6256</p>		38.05	16.70	127	4.40	61	MP-742-61S
			(1.50)	(0.66)	(4.99)	(0.17)		
	<p>Receptacle protective dustcap to suit MP-6216</p>		36.9	13.13	127	-	39	MP-742-39L
			(1.45)	(0.52)	(4.99)	-		
	<p>Receptacle protective dustcap to suit MP-6216</p>		43.14	14.15	127	-	61	MP-742-61L
			(1.70)	(0.56)	(4.99)	-		
	<p>Plug protective dustcap to suit MP-6212</p>		31.7	15.9	127	4.40	39	MP-738-39S
			(1.25)	(0.62)	(4.99)	(0.17)		
	<p>Plug protective dustcap to suit MP-6212</p>		38.05	16.70	127	4.40	61	MP-738-61S
			(1.50)	(0.66)	(4.99)	(0.17)		
	<p>Receptacle protective dustcap to suit MP-6211</p>		36.9	13.13	127	-	39	MP-738-39L
			(1.45)	(0.52)	(4.99)	-		
	<p>Receptacle protective dustcap to suit MP-6211</p>		43.14	14.15	127	-	61	MP-738-61L
			(1.70)	(0.56)	(4.99)	-		

STANDARD DATA MP-62 SERIES / MP - 65 SERIES

		VALUE	
GENERAL CHARACTERISTICS	Number of contacts	39	61
	Number of channels	12	20
	Termination	Solder	
	Wire Gauge - Stranded Wire	37 x 24AWG-20AWG 2 x 20AWG-16AWG	24AWG-20AWG
	Environmental	Complies with EU RoHS 2 Directive 2011/65/EU	
ELECTRICAL CHARACTERISTICS	Operating Voltage at Sea level - DC	600V*	
	Operating Voltage at Sea level - AC	600V*	
	Test Voltage AC RMS	1500V	
	Current Carrying Capacity	37 x 7.5A 2 x 13A	7.5A
	Insulation Resistance	5000MΩ	
CLIMATIC CHARACTERISTICS	Protection Class	IP67 (when mated)	
	Operating Temperature	-55°C to +125°C (-67°F to +257°F)	
MECHANICAL CHARACTERISTICS	Cable Retention	PG Gland / NPT Thread	
	Mechanical Operations	500 mating cycles (minimum)	
MATERIALS	Connector / Shell Finish	Aluminium Alloy / Black	
	Insert	Neoprene	
	Male pin contact machined - Plating	Brass / Gold plated	
	Female socket contact machined - Plating	Brass / Gold plated	
CLAMPING CHARACTERISTICS	PG Gland	16	21
	Cable Clamping range mm (inches)	9-14 (0.35"-0.55")	13-18 (0.51"-0.70")

Rev 3 - 03/2013

*Not suitable for domestic applications above 50V



AMPHENOL-TUCHEL C146 HEAVY | MATE CONNECTORS

Amphenol Tuchel C146 series rectangular connectors feature modular components ensuring a vast range of different features and benefits for the end user. The zinc diecast aluminum housings are finished in a durable powder coat and available in either top or side entry. Connector coupling is achieved via a positive locking lever ensuring a positive rapid connection. The C146 series is suitable for general-purpose audio and lighting applications and is completely intermateable with all competitor connectors.



FIBRE OPTIC



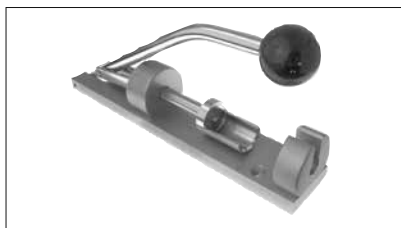







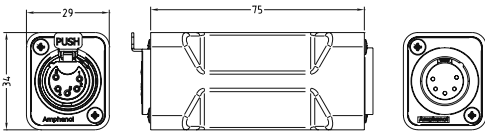

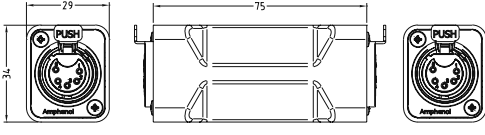

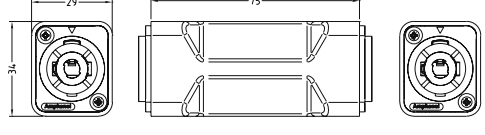

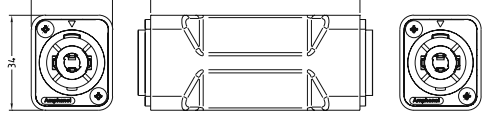
Amphenol has over 25 years experience in fibre optics dating back to their development of the first industry standard connector, the SMA. Today we can offer a complete range of products including Hybrid Fibre optic connectors for HDTV broadcast cameras SMPTE 304M compliant and ruggedised connectors and cable assemblies for indoor or outdoor applications.

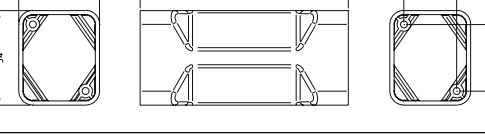

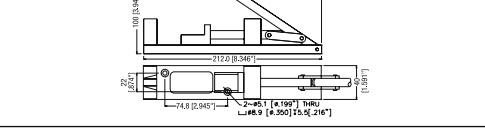

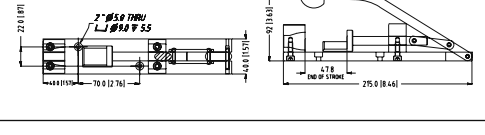

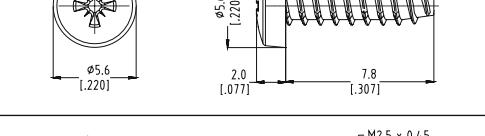
ACCESSORIES

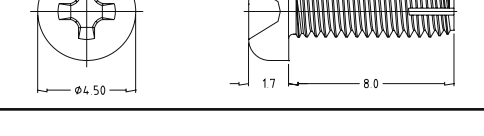
- Colour coded boots(backshells) and rings to assist in cable identification.
- In-line adaptors. Pre-wired for convenience.
- Termination tool for fast assembly of cable connectors.
- Mounting hardware.
- Metal boots(backshells) for rugged environments.

PRODUCT - FIGURE	DRAWING	DESCRIPTION	VARIATIONS	PART NUMBER
		XLR 3 pole male to 3 pole male adapter, Pre wired, Metal Shell	Nickel Finish Black Finish	AC3M3MW AC3M3MBW
		XLR 3 pole female to 3 pole female adapter, Pre wired, Metal Shell	Nickel Finish Black Finish	AC3F3FW AC3F3FBW
		XLR 3 pole female to 3 pole male adapter, Pre wired, Metal Shell	Nickel Finish Black Finish	AC3F3MW AC3F3MBW
		XLR 3 pole female to 5 pole male adapter, Pre wired, Metal Shell	Nickel Finish	AC3F5MW
		XLR 3 pole male to 5 pole female adapter, Pre wired, Metal Shell	Nickel Finish	AC3M5FW
		XLR 5 pole male to 5 pole male adapter, Pre wired, Metal Shell	Nickel Finish	AC5M5MW
		XLR D shell adapter, 3 pole male to 3 pole male, Pre-wired	Not Applicable	AC3M3MDW
		XLR D shell adapter, 3 pole female to 3 pole female, Pre-wired	Not Applicable	AC3F3FDW

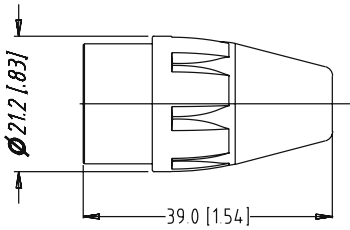

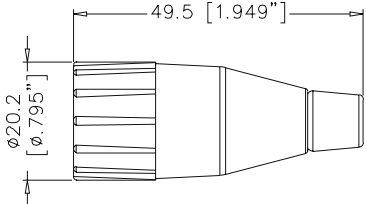

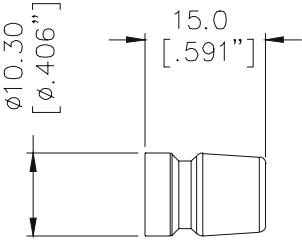

PRODUCT - FIGURE	DRAWING	Dimensions in mm (inches)	DESCRIPTION	VARIATIONS	PART NUMBER
			XLR D shell adapter, 5 pole male to 5 pole male, Pre-wired	Not Applicable	AC5M5MDW
			XLR D shell adapter, 5 pole female to 5 pole female, Pre-wired	Not Applicable	AC5F5FDW
			SP D shell adapter, SP-2 to SP-2, Pre-wired	Not Applicable	SP2F2FDW
			SP D shell adapter, SP-4 to SP-4, Pre-wired	Not Applicable	SP4F4FDW
			D shell adapter without connectors	Not Applicable	AC-D-ADAPTER
			Termination Tool	For AC Series Cable Connectors	T2860
			Termination Tool	For AX Series cable connectors	T2890
			A Type / C Type Connector Mounting, Self-Tapping Screw	2.9 x 1.06 Tri-rondular	52500014-734
			B Type / XLRnet Connector Mounting, Self-Tapping Screw	M2.5	52500005-732

Accessories

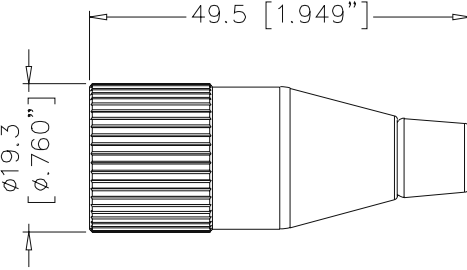
PRODUCT - FIGURE	DRAWING Dimensions in mm (inches)	DESCRIPTION	VARIATIONS	PART NUMBER
		AX Series Coloured Boot	Brown	AX-BOOT-1
			Red	AX-BOOT-2
			Orange	AX-BOOT-3
			Yellow	AX-BOOT-4
			Green	AX-BOOT-5
			Blue	AX-BOOT-6
			Violet	AX-BOOT-7
			Grey	AX-BOOT-8
			White	AX-BOOT-9
			Black	AX-BOOT
		AX Series Sleeve for Custom Print Note: Custom printed numbers available (Please contact us)	Black	AX-MARK0
			Brown	AX-MARK1
			Red	AX-MARK2
			Orange	AX-MARK3
			Yellow	AX-MARK4
			Green	AX-MARK5
			Blue	AX-MARK6
			Violet	AX-MARK7
			Grey	AX-MARK8
White	AX-MARK9			
		AC Coloured Boot / Backshell Note: Number Identification optional. (Please contact us.)	Brown	AC-NUT-BRN
			Red	AC-NUT-RED
			Orange	AC-NUT-ORG
			Yellow	AC-NUT-YEL
			Green	AC-NUT-GRN
			Blue	AC-NUT-BLU
			Violet	AC-NUT-VIO
			Grey	AC-NUT-GRY
			White	AC-NUT-WHT
		Coloured Grommets to suit AC Series, T Series and Musician range	Brown	AC-GROMMET-BRN
			Red	AC-GROMMET-RED
			Orange	AC-GROMMET-ORG
			Yellow	AC-GROMMET-YEL
			Green	AC-GROMMET-GRN
			Blue	AC-GROMMET-GRN
			Violet	AC-GROMMET-VIO
			Grey	AC-GROMMET-GRY
White	AC-GROMMET-WHT			

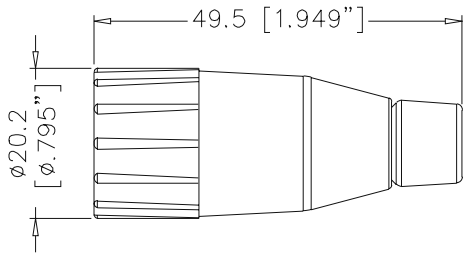
NOTE: All accessories comply with EU RoHS 2 Directive 2011/65/EU

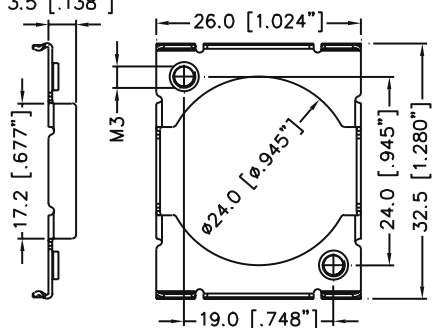
NOTE: Please do not refer to this printed catalogue as a colour reference. For exact colours contact your sales representative.

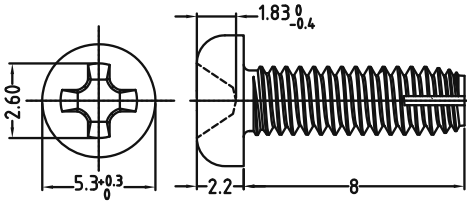
PRODUCT - FIGURE	DRAWING Dimensions in mm (inches)	DESCRIPTION	VARIATIONS	PART NUMBER
		AC Metal Boot / Backshell, Black Finish	Not Applicable	AC-NUT-METAL
		AC Thermoplastic Boot / Backshell. Suitable for use with 8.5mm (0.33") O.D. cable.	Not Applicable	AC-NUT-J-BLK
		M3 threaded metal plate to suit D-type chassis connectors	Nickel Finish	52590060-300
		M3 x 0.5mm thread Dual rear panel clip	Nickel Finish	52590074-300
		M3 Screw to suit 52590060-300 M3 x 0.5	Nickel Finish Matt Black	52500016-300 52500016-400

Connector Wiring Information

CONNECTOR WIRING INFORMATION

XLR (Microphone / Patch Cables)

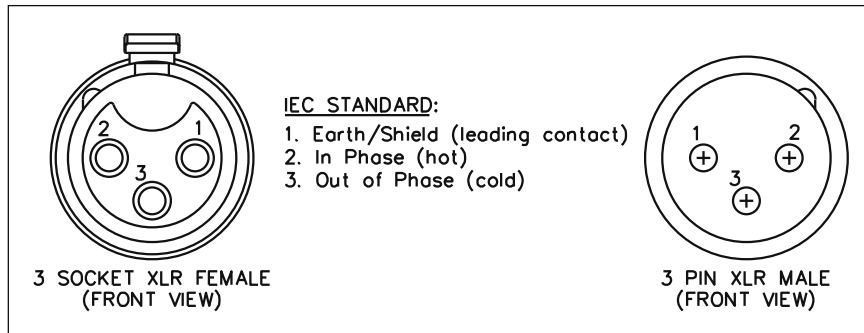

The standard XLR 3 contact pin outs are as shown above for a balanced lead. In such a configuration audio "Hot" (pin 2) is the in-phase connection whilst audio "Cold" (pin 3) is the out-of-phase connection. For an unbalanced lead however, you may connect pin 1 to either pin 2 or pin 3, but not both. In such a configuration the remaining pin is used for the audio signal.

When terminating the cable shielding to pin 1 it is suggested that the shield be only grounded at one end of the cable to avoid inducing "hum". Pin 1 is a leading contact that engages at interconnection, before pin 2 or pin 3.

1/4" Phono (6.35mm) (Standard Applications)

MICROPHONE CABLE - BALANCED

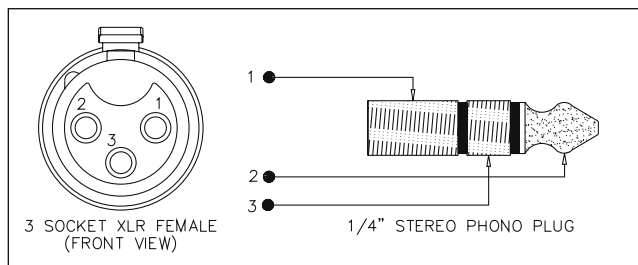

MICROPHONE CABLE - UNBALANCED

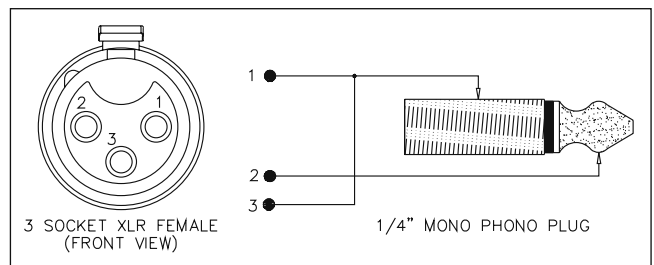

INSTRUMENT / LINE CABLE (MONO)

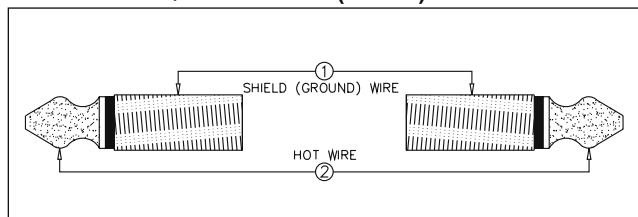

INSTRUMENT / LINE CABLE (STEREO)

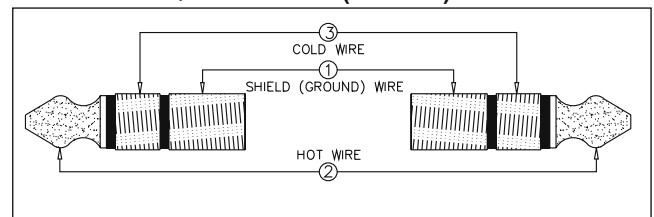

MP Series

MP-41 Series
4 Ch – 13 pin

Ch	+	-	G
1	B	C	E
2	F	K	H
3	J	D	A
4	N	M	G
General	L		
Ground			

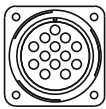

MP-41 Series
6 Ch – 19 pin

Ch	+	-	G
1	L	M	U
2	A	N	B
3	K	J	T
4	V	P	C
5	H	S	G
6	R	D	E
General	F		
Ground			

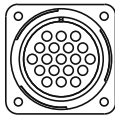

MP-41 Series
8 Ch – 25 pin

Ch	+	-	G
1	A	E	F
2	G	C	B
3	D	H	J
4	M	L	K
5	Q	P	N
6	W	S	R
7	T	X	Y
8	Z	V	U
General	a		
Ground			

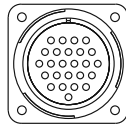

MP-41 Series
12 Ch – 37 pin

Ch	+	-	G
1	E	F	A
2	B	C	G
3	H	J	D
4	S	T	K
5	L	M	U
6	V	W	N
7	P	R	X
8	a	b	g
9	c	d	j
10	e	f	m
11	n	p	h
12	r	s	k
General	z		
Ground			

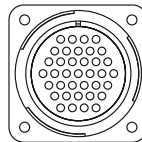

MP-41 Series
16 Ch – 54 pin

Ch	+	-	G
1	W	f	r
2	J	R	a
3	k	v	AC
4	E	M	V
5	e	q	y
6	B	H	P
7	Z	j	u
8	D	L	U
9	d	p	x
10	A	G	O
11	Y	h	t
12	C	K	T
13	c	n	w
14	F	N	X
15	g	s	AB
16	S	b	m
General	AG		
Ground			

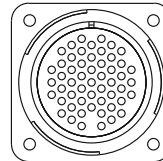

MP-41 Series
28 Ch – 85 pin

Ch	+	-	G
1	A	B	C
2	E	F	H
3	J	K	L
4	N	P	R
5	S	T	U
6	X	Y	Z
7	a	b	c
8	d	f	g
9	h	i	j
10	k	m	n
11	p	q	r
12	t	u	v
13	w	x	y
14	z	AA	AB
15	AC	AD	AE
16	AF	AH	AJ
17	AK	AL	AM
18	AP	AR	AS
19	AT	AU	AV
20	AW	AX	AY
21	AZ	BA	BB
22	BC	BD	BE
23	BJ	BK	BL
24	BM	BN	BP
25	BS	BT	BU
26	BV	BR	BF
27	BH	AN	s
28	W	M	D
General	V		
Ground			

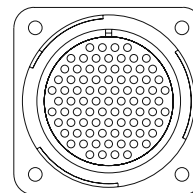

MP-41 Series
48 Ch - 150 pin

Ch	+	-	G
1	1	2	3
2	5	6	7
3	8	9	10
4	11	12	13
5	14	15	16
6	17	18	19
7	21	22	23
8	24	25	26
9	27	28	29
10	20	30	31
11	32	33	34
12	35	36	37
13	38	39	40
14	41	42	43
15	44	45	46
16	47	48	49
17	50	51	52
18	53	54	55
19	57	58	59
20	60	61	62
21	63	64	65
22	66	67	68
23	69	70	71
24	72	73	74
25	75	76	77
26	78	79	80
27	82	83	84
28	85	86	87
29	88	89	90
30	91	92	93
31	94	95	96
32	97	98	99
33	100	101	102
34	103	104	105
35	56	81	106
36	107	108	109
37	110	111	112
38	113	114	115
39	116	117	118
40	119	120	121
41	122	123	124
42	125	126	127
43	139	128	129
44	130	131	132
45	133	134	135
46	136	137	138
47	140	141	142
48	143	144	145
General			
Ground	150		

MP-62 Series
12 Ch – 39 pin

Ch	+	-	G
1	p	n	q
2	W	A	X
3	N	f	P
4	L	e	M
5	J	d	K
6	G	c	H
7	E	b	F
8	D	a	Z
9	C	B	Y
10	U	j	V
11	i	h	T
12	R	g	S
General	N/A		
Ground			

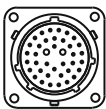

MP-62 Series
20 Ch – 61 pin

Ch	+	-	G
1	JJ	HH	NN
2	MM	KK	PP
3	BB	AA	CC
4	s	FF	W
5	r	EE	V
6	e	D	x
7	f	E	y
8	q	DD	U
9	S	p	T
10	P	N	R
11	m	k	n
12	L	K	M
13	J	i	j
14	H	G	h
15	g	F	z
16	d	C	w
17	B	A	c
18	b	a	Z
19	v	u	Y
20	t	GG	X
General	N/A		
Ground			

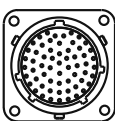

INDEX

Symbols	AC3MAH-AU-PRE	44	AC5FAH-AU-B	46	AC7FDZ BULK	25	ACJC10S BULK	63
52500005-732	AC3MAV2-AU-PRE	45	AC5FAV-AU-B	46	AC7FDZV	25	ACJC10SL BULK	63
52500014-734	AC3MAV-AU-PRE	44	AC5FB	13	AC7FDZVB	25	ACJC10V BULK	62
52500016-300	AC3MB	12	AC5FB-AU	13	AC7FJ	14	ACJC10VL BULK	62
52500016-400	AC3MB-AU	12	AC5FB BULK	13	AC7FPZ	26	ACJD-BLK	143
52590060-300	AC3MB BULK	12	AC5FBH-AU-PRE	50	AC7M	14	ACJD-BLU	143
52590074-300	AC3MBH1-AU-PRE	47	AC5FBJ	13	AC7MB	14	ACJD-GRN	143
	AC3MBH2-AU-PRE	47	AC5F BULK	13	AC7MB BULK	14	ACJD-RED	143
A	AC3MBH3-AU-PRE	47	AC5FBV-AU-PRE	50	AC7MBJ	14	ACJD-WHT	143
AC3F	AC3MBH-AU-PRE	47	AC5FDZ	24	AC7M BULK	14	ACJD-YEL	143
AC3F3FBW	AC3MBHL-AU-PRE	47	AC5FDZB	24	AC7MDZ	25	ACJM-HHDR	129
AC3F3FDW	AC3MBJ	12	AC5FDZB-AU	24	AC7MDZB	25	ACJM-HHOP	130
AC3F3FW	AC3M BULK	12	AC5FDZ BULK	24	AC7MDZ BULK	25	ACJM-HHOP-1	130
AC3F3MBW	AC3MBV1-AU-PRE	48	AC5FJ	13	AC7MDZV	25	ACJM-IH	131
AC3F5MW	AC3MBV2-AU-PRE	48	AC5FPZ	26	AC7MDZVB	25	ACJM-IHS	131
AC3FAH1-AU-PRE	AC3MBV3-AU-PRE	48	AC5M	13	AC7MJ	14	ACJM-MC	131
AC3FAH2-AU-PRE	AC3MBV-AU-PRE	47	AC5M5MDW	155	AC7MP	26	ACJM - MH	130
AC3FAH-AU-PRE	AC3MCP	16	AC5M5MW	154	AC7MPNZ	26	ACJM-MHD	132
AC3FAHL1-AU-PRE	AC3MCP BULK	16	AC5MAH-AU-B	46	AC-D-ADAPTER	155	ACJM-MHD985	129
AC3FAHL2-AU-PRE	AC3MDZ	23	AC5MAV-AU-B	46	AC-GROMMET-BRN	156	ACJM-MHDC*	131
AC3FAHL-AU-PRE	AC3MDZB	23	AC5MB	13	AC-GROMMET-GRN	156	ACJM-MHDCM	131
AC3FAV1-AU-PRE	AC3MDZB-AU	23	AC5MB-AU	13	AC-GROMMET-GRY	156	ACJM-MHDE	132
AC3FAV2-AU-PRE	AC3MDZ BULK	23	AC5MB BULK	13	AC-GROMMET-ORG	156	ACJM-MHDEM	132
AC3FAV-AU-PRE	AC3MJ	12	AC5MBH-AU-PRE	50	AC-GROMMET-RED	156	ACJM-MHDM	132
AC3FAVL1-AU-PRE	AC3MM	12	AC5MBJ	13	AC-GROMMET-VIO	156	ACJM-MHDR	130
AC3FAVL2-AU-PRE	AC3MMB	12	AC5M BULK	13	AC-GROMMET-WHT	156	ACJM-MHDRM	130
AC3FAVL-AU-PRE	AC3MMB-AU	12	AC5MBV-AU-PRE	50	AC-GROMMET-YEL	156	ACJM-MHOM	130
AC3FB	AC3MMB BULK	12	AC5MDZ	24	AC-HDMI-RR	110	ACJM-MHOP	130
AC3FB-AU	AC3MM BULK	12	AC5MDZB	24	AC-HDMI-RRB	110	ACJM-MHOP-1	130
AC3FB BULK	AC3MMCP	16	AC5MDZB-AU	24	ACJC5H BULK	60	ACJM-MHR	131
AC3FBH1-AU-PRE	AC3MMCP BULK	16	AC5MDZ BULK	24	ACJC5HL BULK	60	ACJM-MHS	131
AC3FBH2-AU-PRE	AC3MMDZ	23	AC5MJ	13	ACJC5S BULK	60	ACJM-MIV-2	132
AC3FBH3-AU-PRE	AC3MMDZB	23	AC5MP	26	ACJC5SL BULK	60	ACJM-MIV-2S	132
AC3FBH-AU-PRE	AC3MMDZB-AU	23	AC5MPNZ	26	ACJC5V BULK	60	ACJM-MN-2	132
AC3FBHL1-AU-PRE	AC3MMDZ BULK	23	AC6AF	14	ACJC5VL BULK	60	ACJM-MN-2S	132
AC3FBHL2-AU-PRE	AC3MMP	26	AC6AFB	14	ACJC6AH BULK	58	ACJM-MV-2	132
AC3FBHL3-AU-PRE	AC3MMPNZ	26	AC6AFB-AU	14	ACJC6AHL BULK	58	ACJM-MV-2S	132
AC3FBHL-AU-PRE	AC3MP	26	AC6AFB BULK	14	ACJC6AV2 BULK	58	ACJM-MV35-2	129
AC3FBJ	AC3MPNZ	26	AC6AFBJ	14	ACJC6AV2L BULK	58	ACJM-MV35-2S	129
AC3F BULK	AC4F	13	AC6AF BULK	14	ACJC6AV BULK	58	ACJM-MVD985-2	129
AC3FBV1-AU-PRE	AC4FB	13	AC6AFDZ	25	ACJC6AVL BULK	58	ACJM-MVD985-2S	129
AC3FBV2-AU-PRE	AC4FB-AU	13	AC6AFDZB	25	ACJC6H BULK	61	ACJM-MVS-2	133
AC3FBV3-AU-PRE	AC4FB BULK	13	AC6AFDZB-AU	25	ACJC6HL BULK	61	ACJM-MVS-2S	133
AC3FBV-AU-PRE	AC4FBJ	13	AC6AFDZ BULK	25	ACJC6S BULK	61	ACJM-NH35	129
AC3FBVL1-AU-PRE	AC4F BULK	13	AC6AFJ	14	ACJC6SL BULK	61	ACJM-NV35-2	129
AC3FBVL2-AU-PRE	AC4FDZ	24	AC6AFPZ	26	ACJC6V BULK	61	ACJM-NV35-2S	129
AC3FBVL3-AU-PRE	AC4FDZB	24	AC6AM	14	ACJC6VL BULK	61	ACJM-PC	131
AC3FBVL-AU-PRE	AC4FDZB-AU	24	AC6AMB	14	ACJC9AH BULK	58	ACJM - PH	130
AC3FCP	AC4FDZ BULK	24	AC6AMB-AU	14	ACJC9AHL BULK	58	ACJM-PHOP	130
AC3FCP BULK	AC4FJ	13	AC6AMB BULK	14	ACJC9AV2 BULK	59	ACJM-PHOP-1	130
AC3FDZ	AC4FPZ	26	AC6AMBJ	14	ACJC9AV2L BULK	59	ACJM-PHR	131
AC3FDZB	AC4M	13	AC6AM BULK	14	ACJC9AVL BULK	59	ACJM-PHS	131
AC3FDZB-AU	AC4MAH-AU-B	46	AC6AMDZ	25	ACJC9H BULK	61	ACJM-PVB-2	132
AC3FDZ BULK	AC4MB	13	AC6AMDZB	25	ACJC9HL BULK	61	ACJM-PVB-2S	132
AC3FJ	AC4MB-AU	13	AC6AMDZB-AU	25	ACJC9S BULK	62	ACJR-BLK	142
AC3FPZ	AC4MB BULK	13	AC6AMDZ BULK	25	ACJC9SL BULK	62	ACJR-BLU	142
AC3M	AC4MBJ	13	AC6AMJ	14	ACJC9V BULK	62	ACJR-GRN	142
AC3M3MBW	AC4M BULK	13	AC6AMP	26	ACJC9VL BULK	62	ACJR-RED	142
AC3M3MDW	AC4MDZ	24	AC6AMPNZ	26	ACJC10AH BULK	59	ACJR-SBK	142
AC3M3MW	AC4MDZB	24	AC7F	14	ACJC10AHL BULK	59	ACJR-SBL	142
AC3M5FW	AC4MDZB-AU	24	AC7FB	14	ACJC10AV2 BULK	59	ACJR-SGR	142
AC3MA-AU-PRE	AC4MJ	13	AC7FB BULK	14	ACJC10AV2L BULK	59	ACJR-SRD	142
AC3MAH1-AU-PRE	AC4MP	26	AC7FBJ	14	ACJC10AV BULK	59	ACJR-SWH	142
AC3MAH2-AU-PRE	AC4MPNZ	26	AC7F BULK	14	ACJC10AVL BULK	59	ACJR-SYL	142
AC3MAH4-SW-B	AC5F	13	AC7FDZ	25	ACJC10H BULK	62	ACJR-WHT	142
	AC5F5FDW	155	AC7FDZB	25	ACJC10HL BULK	62	ACJR-YEL	142

ACJS-HHDR	129	ACPM-GB	125	AG4FCRV	67	AX4M	6	AXS3FP1H	31
ACJS-HHOP	130	ACPM-GB-AU	125	AG4FL	66	AX4MB	6	AXS3FP1V	31
ACJS-HHOP-1	130	ACPM-GB BULK	125	AG4M	66	AX4MB-AU	6	AXS3FP2	30
ACJS-IH	131	ACPM-GN	125	AG4MCC	66	AX4MB BULK	6	AXS3FP2H	31
ACJS-IHS	131	ACPM-GN-AU	125	AG4MCCH	66	AX4M BULK	6	AXS3FP2V	31
ACJS-MC	131	ACPM-GN BULK	125	AG4MPCH	67	AX4MD	20	AXS3FPH	31
ACJS - MH	131	ACPM-KB	123	AG5F	66	AX4MDB	20	AXS3FPV	31
ACJS-MHD	132	ACPM-KB-AU	123	AG5FCCH	66	AX4MDB-AU	20	AXS3MP	30
ACJS-MHD985	129	ACPM-KN	123	AG5FCE	66	AX4MD-M3	20	AXS3MP1	30
ACJS-MHDC*	131	ACPM-KN-AU	123	AG5FCRV	67	AX4MDV	20	AXS3MP1H	30
ACJS-MHDCM	131	ACPM-RB	126	AG5FL	66	AX4MDVB	20	AXS3MP1V	31
ACJS-MHDE	132	ACPM-RB-AU	126	AG5M	66	AX4MDV-M3	20	AXS3MP2	30
ACJS-MHDEM	132	ACPM-RB BULK	126	AG5MCC	66	AX5F	6	AXS3MP2H	30
ACJS-MHDM	132	ACPM-RN	126	AG5MCCH	66	AX5FB	6	AXS3MP2V	31
ACJS-MHDR	130	ACPM-RN-AU	126	AG6F	66	AX5FB-AU	6	AXS3MPH	30
ACJS-MHDRM	130	ACPM-RN BULK	126	AG6FCCH	66	AX5FB BULK	6	AXS3MPV	31
ACJS-MHOM	130	ACPM-TB	124	AG6FCE	66	AX5F BULK	6	AXS4FP	31
ACJS-MHOP	130	ACPM-TB-AU	124	AG6FCRV	67	AX5FD	21	AXS4FP1	31
ACJS-MHOP-1	130	ACPM-TB BULK	124	AG6FL	66	AX5FD-M3	21	AXS4FP1H	32
ACJS-MHR	131	ACPM-TN	124	AG6M	66	AX5FDV	21	AXS4FP1V	32
ACJS-MHS	131	ACPM-TN-AU	124	AG6MCC	66	AX5FDV-M3	21	AXS4FP2	31
ACJS-MIV-3	132	ACPM-TN BULK	124	AG6MCCCH	66	AX5M	6	AXS4FP2H	32
ACJS-MIV-3S	132	ACPR-BLK	142	AP-4-11	82	AX5MB	6	AXS4FP2V	32
ACJS-MIV-5	132	ACPR-BLU	142	AP-4-12	82	AX5MB-AU	6	AXS4FPH	32
ACJS-MN-3	132	ACPR-GRN	142	AP-4-21	82	AX5MB BULK	6	AXS4FPV	32
ACJS-MN-3S	132	ACPR-RED	142	AP-4-22	82	AX5M BULK	6	AXS4MP	31
ACJS-MN-5	132	ACPR-SBK	142	AP-5-11	82	AX5MD	20	AXS4MP1	31
ACJS-MV-3	132	ACPR-SBL	142	AP-5-12	82	AX5MDB	20	AXS4MP1H	32
ACJS-MV-3S	132	ACPR-SGR	142	AP-5-21	82	AX5MDB-AU	20	AXS4MP1V	32
ACJS-MV-5	132	ACPR-SRD	142	AP-5-22	82	AX5MD-M3	20	AXS4MP2	31
ACJS-MV35-3	129	ACPR-SWH	142	AP-6-11	82	AX5MDV	20	AXS4MP2H	32
ACJS-MV35-3S	129	ACPR-SYL	142	AP-6-12	82	AX5MDVB	20	AXS4MP2V	32
ACJS-MV35-5	129	ACPR-WHT	142	AP-6-21	82	AX5MDV-M3	20	AXS4MPH	32
ACJS-MVD985-3	129	ACPR-YEL	142	AP-6-22	82	AX6AFD	21	AXS4MPV	32
ACJS-MVD985-3S	129	ACPS-GB	125	AP-8-11	82	AX6AFDB	21	AXS5FP	33
ACJS-MVD985-5	129	ACPS-GB-AU	125	AP-8-12	82	AX6AFD-M3	21	AXS5FP1	33
ACJS-MVS-3	133	ACPS-GB BULK	125	AP-8-21	82	AX6AFDV	21	AXS5FP1H	33
ACJS-MVS-3S	133	ACPS-GN	125	AP-8-22	82	AX6AFDVB	21	AXS5FP1V	33
ACJS-MVS-5	133	ACPS-GN-AU	125	AX3FD	19	AX6AFDV-M3	21	AXS5FP2	33
ACJS-NH35	129	ACPS-GN BULK	125	AX3FDB	19	AX6AMD	21	AXS5FP2H	33
ACJS-NV35-3	129	ACPS-KB	123	AX3FDB-AU	19	AX6AMDB	21	AXS5FP2V	33
ACJS-NV35-3S	129	ACPS-KB-AU	123	AX3FDB-M3	19	AX6AMDB-AU	21	AXS5FPH	33
ACJS-NV35-5	129	ACPS-KN	123	AX3FD-M3	19	AX6AMD-M3	21	AXS5FPV	33
ACJS-PC	131	ACPS-KN-AU	123	AX3M	5	AX6AMDV	21	AXS5MP	32
ACJS - PH	131	ACPS-RB	126	AX3MB	5	AX6AMDVB	21	AXS5MP1	32
ACJS-PHOP	130	ACPS-RB-AU	126	AX3MB-AU	5	AX6AMDV-M3	21	AXS5MP1H	33
ACJS-PHOP-1	130	ACPS-RB BULK	126	AX3MB BULK	5	AX6FADB-AU	21	AXS5MP1V	33
ACJS-PHR	131	ACPS-RN	126	AX3M BULK	5	AX-BOOT	156	AXS5MP2	32
ACJS-PHS	131	ACPS-RN-AU	126	AX3MD	19	AX-BOOT-1	156	AXS5MP2H	33
ACJS-PVB-3	132	ACPS-RN BULK	126	AX3MDB	19	AX-BOOT-2	156	AXS5MP2V	33
ACJS-PVB-3S	132	ACPS-TB	124	AX3MDB-AU	19	AX-BOOT-3	156	AXS5MPH	33
ACJS-PVB-5	132	ACPS-TB-AU	124	AX3MDB-M3	19	AX-BOOT-4	156	AXS5MPV	33
AC-NUT-BLU	156	ACPS-TB BULK	124	AX3MD-M3	19	AX-BOOT-5	156	AXX3F	5
AC-NUT-BRN	156	ACPS-TN	124	AX3MDV	19	AX-BOOT-6	156	AXX3FB-AU	5
AC-NUT-GRN	156	ACPS-TN-AU	124	AX3MDVB	19	AX-BOOT-7	156	AXX3FB BULK	5
AC-NUT-GRY	156	ACPS-TN BULK	124	AX3MDVB-M3	19	AX-BOOT-8	156	AXX3F BULK	5
AC-NUT-J-BLK	157	AC-USB3-AA	110	AX3MDV-M3	19	AX-BOOT-9	156	E	
AC-NUT-METAL	157	AC-USB3-AAB	110	AX4F	6	AX-MARK0	156	EP-3-11P	80
AC-NUT-ORG	156	AG3F	66	AX4FB	6	AX-MARK1	156	EP-3-11PB	80
AC-NUT-RED	156	AG3FCCH	66	AX4FB-AU	6	AX-MARK2	156	EP-3-12	80
AC-NUT-VIO	156	AG3FCE	66	AX4FB BULK	6	AX-MARK3	156	EP-3-12B	80
AC-NUT-WHT	156	AG3FCRV	67	AX4F BULK	6	AX-MARK4	156	EP-3-13P	81
AC-NUT-YEL	156	AG3FL	66	AX4FD	20	AX-MARK5	156	EP-3-13PB	81
ACPL-CBK	142	AG3M	66	AX4FDB	20, 21	AX-MARK6	156	EP-3-14	81
ACPL-CBL	142	AG3MCC	66	AX4FDB-AU	20, 21	AX-MARK7	156	EP-3-14B	81
ACPL-CGR	142	AG3MCCH	66	AX4FD-M3	20	AX-MARK8	156	EP-4-11P	80
ACPL-CRD	142	AG4F	66	AX4FDV	20	AX-MARK9	156	EP-4-11PB	80
ACPL-CWH	142	AG4FCCH	66	AX4FDVB	20, 21	AXS3FP	30	EP-4-12	80
ACPL-CYL	142	AG4FCE	66	AX4FDV-M3	20	AXS3FP1	30		

Index

EP-4-12B	80	KM2PB	138	MP-4164-25S	147	MP-INS-16	149	RJX8FB6HB	99
EP-4-13P	81	KM2PB-AU	138	MP-4164-25S-C	147	MP-INS-18	149	RJX8FB6HEB	100
EP-4-13PB	81	KM2PB BULK	138	MP-4164-37S	147			RJX8FB6HGRB	99
EP-4-14	81	KM2P BULK	138	MP-4164-37S-C	147	Q		RJX8FB6HGREB	100
EP-4-14B	81	KS3P	138	MP-4164-54S	147	QM2P	120	RJX8FB6HGYB	99
EP-5-11P	80	KS3P-AU	138	MP-4164-54S-C	147	QM2PB-AU	120	RJX8FB6HGYEB	100
EP-5-11PB	80	KS3PB	138	MP-4164-85S	147	QM2R	121	RJX8FB6HLPB	99
EP-5-12	80	KS3PB-AU	138	MP-4164-85S-C	147	QM2RB-AU	121	RJX8FB6HLPB	100
EP-5-12B	80	KS3PB BULK	138	MP-4164-150S	147	QS3P	120	RJX8FB6HRGB	99
EP-5-13P	81	KS3P BULK	138	MP-4164-150S-C	147	QS3PB-AU	120	RJX8FB6HRGEB	100
EP-5-13PB	81	KS3PC	138	MP-6211-39S	151	QS3R	121	RJX8FB6HRRB	99
EP-5-14	81	KS3PC-AU	138	MP-6211-39S-C	151	QS3RB-AU	121	RJX8FB6HRREB	100
EP-5-14B	81			MP-6211-61S	151			RJX8FB6HRYB	99
EP-6-11P	80	M		MP-6211-61S-C	151	R		RJX8FB6HRYEB	100
EP-6-11PB	80	M22520/1-01	149	MP-6212-39S	152	RJD32A3-0050	91	RJX8FB6HUUB	99
EP-6-12	80	MP-738-39L	152	MP-6212-39S-C	152	RJD32U1-0050	91	RJX8FB6HUUEB	100
EP-6-12B	80	MP-738-39S	152	MP-6212-61S	152	RJD1112-0050	91	RJX8FB6V2B	100
EP-6-13P	81	MP-738-61L	152	MP-6212-61S-C	152	RJD1212-0050	91	RJX8FB6V2EB	101
EP-6-13PB	81	MP-738-61S	152	MP-6216-39P	151	RJD2103-0050	91	RJX8FB6V2LPB	100,
EP-6-14	81	MP-742-39L	152	MP-6216-39P-C	151	RJD2203-0050	91	101	
EP-6-14B	81	MP-742-39S	152	MP-6216-61P	151	RJX8FA3HB	99	RJX8FB6V2LPB	101
EP-8-11P	80	MP-742-61L	152	MP-6216-61P-C	151	RJX8FA3VB	100	RJX8FB6VB	100
EP-8-11PB	80	MP-742-61S	152	MP-6256-39P	152	RJX8FA5V2B	100	RJX8FB6VEB	101
EP-8-12	80	MP-4101-13P	146	MP-6256-39P-C	152	RJX8FA5VB	100	RJX8FB6VGRB	101
EP-8-12B	80	MP-4101-13P-C	146	MP-6256-61P	152	RJX8FA6HB	99	RJX8FB6VGREB	101
EP-8-13P	81	MP-4101-19P	146	MP-6256-61P-C	152	RJX8FA6V2B	100	RJX8FB6VGYB	101
EP-8-13PB	81	MP-4101-19P-C	146	MP-6511-39S	151	RJX8FA6VB	100	RJX8FB6VGYEB	101
EP-8-14	81	MP-4101-25P	146	MP-6511-39S-C	151	RJX8FB3HB	99	RJX8FB6VLPB	100,
EP-8-14B	81	MP-4101-25P-C	146	MP-6511-61S	151	RJX8FB3HEB	100	101	
		MP-4101-37P	146	MP-6511-61S-C	151	RJX8FB3VB	100	RJX8FB6VLPB	101
H		MP-4101-37P-C	146	MP-6516-39P	151	RJX8FB3VEB	101	RJX8FB6VRGB	101
HP-3-F	85	MP-4101-54P	146	MP-6516-39P-C	151	RJX8FB5HB	99	RJX8FB6VRGEB	101
HP-3-FG	85	MP-4101-54P-C	146	MP-6516-61P	151	RJX8FB5HEB	100	RJX8FB6VRRB	101
HP-3-MD	85	MP-4101-85P	146	MP-6516-61P-C	151	RJX8FB5HGRB	99	RJX8FB6VRRREB	101
HP-3-MDG	85	MP-4101-85P-C	146	MP-25042-13L	147	RJX8FB5HGRCB	99	RJX8FB6VRYB	101
HP-3-MDGW	85	MP-4101-150P	146	MP-25042-13S	147	RJX8FB5HGRCB	100	RJX8FB6VRYEB	101
HP-3-MDW	85	MP-4101-150P-C	146	MP-25042-19L	147	RJX8FB5HGYB	99	RJX8FB6VUUB	101
HPT-3-CC	87	MP-4102-13P	147	MP-25042-19S	147	RJX8FB5HGYEB	100	RJX8FB6VUUEB	101
HPT-3-F	87	MP-4102-13P-C	147	MP-25042-25L	147	RJX8FB5HLPB	99	RJX8FB6VUUEB	101
HPT-3-FD	87	MP-4102-19P	147	MP-25042-25S	147	RJX8FB5HLPB	100	RJX8FD3HB	105
HPT-3-FDW	87	MP-4102-19P-C	147	MP-25042-37L	147	RJX8FB5HLPB	100	RJX8FD3VB	105
HPT-3-FJ	87	MP-4102-25P	147	MP-25042-37L	147	RJX8FB5HLPB	99	RJX8FD5HB	105
HPT-3-M	87	MP-4102-25P-C	147	MP-25042-37S	147	RJX8FB5HLPB	100	RJX8FD5I	105
HPT-3-MD	87	MP-4102-37P	147	MP-25042-54L	147	RJX8FB5HRRB	99	RJX8FD5T	105
HPT-3-MDW	87	MP-4102-37P-C	147	MP-25042-54S	147	RJX8FB5HRRB	100	RJX8FD5VB	105
HPT-3-MJ	87	MP-4102-54P	147	MP-25042-85L	147	RJX8FB5HRYB	99	RJX8FD6HB	105
HPT-CAPD	88	MP-4102-54P-C	147	MP-25042-85S	147	RJX8FB5HRYEB	100	RJX8FD6I	105
HPT-CAPF	88	MP-4102-85P	147	MP-25042-150L	147	RJX8FB5SHUUB	99	RJX8FD6VB	105
HPT-CAPM	88	MP-4102-85P-C	147	MP-25042-150S	147	RJX8FB5SHUUB	100	RJX8FD5110	105
HPT-CAPSD	88	MP-4102-150P	147	MP-25043-13L	148	RJX8FB5V2B	100	RJX8FD6110	105
HPT-CAPSF	88	MP-4102-150P-C	147	MP-25043-13S	148	RJX8FB5V2EB	101	RJX8M	94, 96
HPT-CAPSM	88	MP-4102-150P-C	147	MP-25043-19L	148	RJX8FB5V2LPB	100,	RJX8MB	94, 96
HPT-RT	88	MP-4106-13S	146	MP-25043-19S	148	101		RJX8MB BULK	94, 96
		MP-4106-13S-C	146	MP-25043-25L	148	RJX8FB5V2LPB	101	RJX8M BULK	94, 96
		MP-4106-19S	146	MP-25043-25S	148	RJX8FB5V2LPB	100	RJXS8FD3HB	106
		MP-4106-19S-C	146	MP-25043-37L	148	101		RJXS8FD3VB	106
J		MP-4106-25S	146	MP-25043-37S	148	RJX8FB5VGRB	101	RJXS8FD5HB	106
JM2P	116	MP-4106-25S-C	146	MP-25043-54L	148	RJX8FB5VGRB	101	RJXS8FD5I	106
JM2P-AU	116	MP-4106-37S	146	MP-25043-54S	148	RJX8FB5VGYB	101	RJXS8FD5T	106
JM2PB	116	MP-4106-37S-C	146	MP-25043-85L	148	RJX8FB5VGYEB	101	RJXS8FD5VB	106
JM2PB-AU	116	MP-4106-54S	146	MP-25043-85S	148	RJX8FB5VLPB	100,	RJXS8FD6HB	106
JM2P BULK	116	MP-4106-54S-C	146	MP-25043-150L	148	101		RJXS8FD6I	106
JS3P	116	MP-4106-85S	146	MP-25043-150S	148	RJX8FB5VLPB	101	RJXS8FD6VB	106
JS3P-AU	116	MP-4106-85S-C	146	MP-108300	149	RJX8FB5VLRB	101	RJXS8FD5110	106
JS3PB	116	MP-4106-150S	146	MP-108400	149	RJX8FB5VRRB	101	RJXS8FD6110	106
JS3PB-AU	116	MP-4106-150S-C	146	MP-108500	149	RJX8FB5VRRB	101	RJXS8FG3HB	106
		MP-4164-13S	147	MP-108600	149	RJX8FB5VRRB	101	RJXS8FG3VB	106
K		MP-4164-13S-C	147	MP-EXT-16/18	149	RJX8FB5VRYB	101	RJXS8FG5HB	106
KM2P	138	MP-4164-19S	147	MP-GUIDE-16	149	RJX8FB5VRYEB	101	RJXS8FG5I	106
KM2P-AU	138	MP-4164-19S-C	147	MP-GUIDE-18	149	RJX8FB5VUUB	101	RJXS8FG5T	106
		MP-4164-19S-C	147			RJX8FB5VUUEB	101		

RJXS8FG5VB	106	SP-2-FBSL	71	TM1PB	118
RJXS8FG6HB	106	SP-2-FBTX	71	TM1PB-AU	118
RJXS8FG6I	106	SP-2-FG	71	TM1PBJ	118
RJXS8FG6VB	106	SP-2-FGTX	71	TM1PJ	118
RJXS8FG5110	106	SP-2-FL	71	TM1RBJ	118
RJXS8FG6110	106	SP-2-FLTX	71	TM1RBJ-AU	118
RJXS8FP5H	36	SP-2-FN	71	TM1RJ	118
RJXS8FP5HE	36	SP-2-FNG	71	TM1RJ-AU	118
RJXS8FP5HP	36	SP-2-FNGTX	71	TM2P	114
RJXS8FP5HPE	36	SP-2-FNL	71	TM2P-AU	114
RJXS8FP5V	37	SP-2-FNLTX	71	TM2PB	114
RJXS8FP5VE	37	SP-2-FNS	71	TM2PB-AU	114
RJXS8FP5VP	37	SP-2-FNSG	71	TM2PB BULK	114
RJXS8FP5VPE	37	SP-2-FNSL	71	TM2PBJ	114
RJXS8FP6H	36	SP-2-FNTX	71	TM2P BULK	114
RJXS8FP6HE	36	SP-2-FS	71	TM2PJ	114
RJXS8FP6HP	36	SP-2-FSG	71	TM2PN	115
RJXS8FP6HPE	36	SP-2-FSL	71	TM2PN-AU	115
RJXS8FP6V	37	SP-2-FTX	71	TM2PN BULK	115
RJXS8FP6VE	37	SP-2-MD	73	TM2PNJ	115
RJXS8FP6VP	37	SP-2-MDH	73	TM2RBJ	115
RJXS8FP6VPE	37	SP-2-MDV	73	TM2RBJ-AU	115
RJXS8FP15H	36	SP-4-F	72	TM2RBJ BULK	115
RJXS8FP15HE	36	SP4F4FDW	155	TM2RJ	115
RJXS8FP15HP	36	SP-4-FB	72	TM2RJ-AU	115
RJXS8FP15HPE	36	SP-4-FBG	72	TS3P	114
RJXS8FP15V	37	SP-4-FBGTX	72	TS3P-AU	114
RJXS8FP15VE	37	SP-4-FBL	72	TS3PB	114
RJXS8FP15VP	37	SP-4-FBLTX	72	TS3PB-AU	114
RJXS8FP15VPE	37	SP-4-FBS	72	TS3PB BULK	114
RJXS8FP16H	36	SP-4-FBSG	72	TS3PBJ	114
RJXS8FP16HE	36	SP-4-FBSL	72	TS3P BULK	114
RJXS8FP16HP	36	SP-4-FBTX	72	TS3PJ	114
RJXS8FP16HPE	36	SP-4-FG	72	TS3RBJ	115
RJXS8FP16V	37	SP-4-FGTX	72	TS3RBJ-AU	115
RJXS8FP16VE	37	SP-4-FL	72	TS3RJ	115
RJXS8FP16VP	37	SP-4-FLTX	72	TS3RJ-AU	115
RJXS8FP16VPE	37	SP-4-FN	72		
RJXS8FP25H	36	SP-4-FNG	72		
RJXS8FP25HE	36	SP-4-FNGTX	72		
RJXS8FP25HP	36	SP-4-FNL	72		
RJXS8FP25HPE	36	SP-4-FNLTX	72		
RJXS8FP25V	37	SP-4-FNS	72		
RJXS8FP25VE	37	SP-4-FNSG	72		
RJXS8FP25VP	37	SP-4-FNSL	72		
RJXS8FP25VPE	37	SP-4-FNTX	72		
RJXS8FP26H	36	SP-4-FS	72		
RJXS8FP26HE	36	SP-4-FSG	72		
RJXS8FP26HP	36	SP-4-FSL	72		
RJXS8FP26HPE	36	SP-4-FTX	72		
RJXS8FP26V	37	SP-4-MC	74		
RJXS8FP26VE	37	SP-4-MD	73		
RJXS8FP26VP	37	SP-4-MD-8	73		
RJXS8FP26VPE	37	SP-4-MDA	73		
RJXX8M	94	SP-4-MDAT	73		
RJXX8MB	94	SP-4-MDH	74		
RJXX8MB BULK	94	SP-4-MDHT	74		
RJXX8M BULK	94	SP-4-MDHT-8	74		
		SP-4-MDT	73, 74		
S		SP-4-MDV	74		
SP-2-F	71	SP-4-MDV-2	74		
SP2F2FDW	155	SP-4-MDVT-8	74		
SP-2-FB	71				
SP-2-FBG	71	T			
SP-2-FBGTX	71	T2860	155		
SP-2-FBL	71	T2890	155		
SP-2-FBLTX	71	TH29-1	149		
SP-2-FBS	71	TM1P	118		
SP-2-FBSG	71	TM1P-AU	118		

PRODUCT SAFETY INFORMATION

This should be read in conjunction with Data Sheet information contained in individual product brochures. Failure to observe the advice in this information sheet and the operating conditions specified in the Data Sheets could result in hazardous situations.

1. Material Content and Physical Form

Electrical connectors do not usually contain hazardous materials. They contain conducting and non-conducting materials. Shells are manufactured in metal and plastic. Insulators can be formed in either natural rubber, synthetic rubber, plastic or glass insulating materials. Contact materials vary with the type of connector and its application. They are usually manufactured from either copper alloys, nickel, alumel, chromel or steel. In special applications, other alloys may be specified.

2. Fire Characteristics and Electric Shock Hazard

There is no fire hazard when the connector is correctly wired and used within the specified parameters. Incorrect wiring or assembly of the connector or careless use of metal tools or conductive fluids, or transit damage to any of the component parts may cause electric shock or burns. Live circuits must not be broken by separating mated connectors as this may cause arcing, ionisation and burning. Heat dissipation is greater at maximum resistance in a circuit. Hot spots may occur when resistance is raised locally by damage, e.g. cracked or deformed contacts, or broken strands of wire. Local overheating may also result from the use of the incorrect application tools or from poor quality soldering.

Overheating may occur if the ratings in the Data Sheets are exceeded and can cause breakdown of insulation and hence electric shock.

If heating is allowed to continue it intensifies by further increasing the local resistance through loss of temper or spring contact, formation of oxide film on contacts and wires, and leakage currents through carbonisation of insulation and tracking points. Fire can then result in the presence of combustible materials and this may release noxious fumes. Overheating may not be visually apparent. Burns may result from touching overheated components.

3. Handling

Care must be taken to avoid damage to any component parts of electrical connectors during installation and use. Although there are normally no sharp edges, care must be taken when handling certain components to avoid injury to fingers. Electrical connectors may be damaged in transit to customers, and damage may result in creation of hazards. Products should therefore be examined prior to installation/use and rejected if found to be damaged.

4. Disposal

Incineration of certain materials may release noxious or even toxic fumes.

5. Application

Connectors with exposed contacts should not be selected for use on the current supply side of an electrical circuit, because an electric shock could result from touching exposed contacts of an unmated connector. Voltages in excess of 30 V.A.C. or 42.5 V.D.C. are potentially hazardous and care should be taken to ensure that such voltages cannot be transmitted in any way to exposed metal parts of the connector body. The connector and wiring should be checked, before making live, to have no damage to metal parts or insulators, no solder blobs, loose strands, conducting lubricants, swarf, or any other

undesired conducting particles. Circuit resistance and continuity check should be made to make certain that there are no low resistance joints or spurious conducting paths. Always use the correct application tools as specified in the Data Sheets. Do not permit untrained personnel to wire, assemble or tamper with connectors. For operation voltage please see appropriate national regulations.

Important General Information

A) Air and creepage paths / Operating voltage.

The admissible operating voltages depend on the individual applications and the valid national and other applicable safety regulations. For this reason the air and creepage path data are only reference values. Observe reduction of air and creepage paths due to PC board and/or harnessing.

B) Other important information

Amphenol Australia Pty Ltd continuously endeavours to improve its products. Therefore, products may deviate from the description, technical data and shape as shown in product brochures.

C) Assembly instructions

If applicable, special assembly instructions have been included in or on the connector packaging. See also separate instructions in product brochures.

DISTRIBUTED BY

International Headquarters

Amphenol Australia Pty Ltd
22 Industry Blvd.
Carrum Downs VIC 3201 Australia
Phone: +61 3 8796 8888
Email: info@amphenol.com.au

Europe

Amphenol Audio Representative Office
August-Haeusser – Str. 10
74080 Heilbronn Germany
Phone: +49 71 31 9 29 0
Email: industrial@amphenol.de

www.amphenolaudio.com.au

© 2025 Amphenol Australia Pty Ltd

Subject to all applicable laws and regulations Amphenol Australia Pty Ltd reserves the right to change specifications of any product, system or service contained in this brochure without liability.
260527

Catalogue Part Number: CAT-AUDIO-01

North America

Amphenol Audio Representative Office
44724 Morley Drive
Clinton Township, MI, USA 48036
Phone: +1 800 394 7732 or +1 586 913 8650
Email: sales@amphenolaudio.com

Asia Pacific

Amphenol Australia (China Operations)
3rd floor, Building 9 Shan Cheng Industrial Zone,
Zhou Shi Road, Shi Yan Street, Bao An District,
Shen Zhen, China 518108
Phone: (+86) 755 8173 8000
Email: apcd@amphenol.com.au